

NOTES

*Removal allowance required.

Title

DIMENSIONAL DATASHEET FOR ROMpak-5 WITH TORQUE LIMIT SWITCHES

Date
300916

A4

Doc Number
ROMpak-5

Ver No
2

Scale
1:7

Sheet No
1 of 3

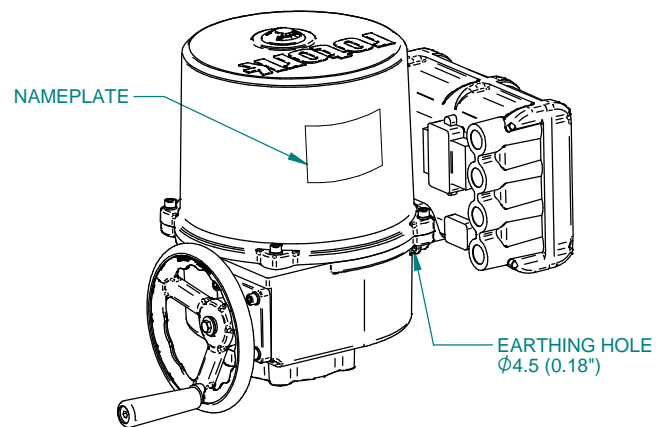
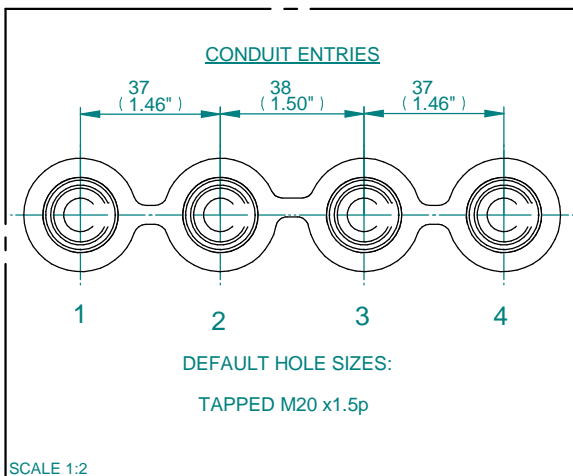
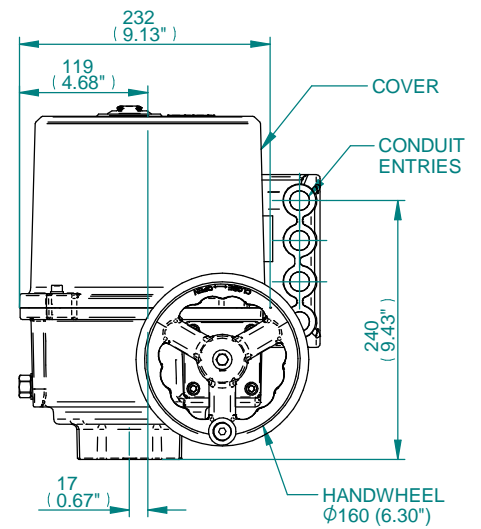
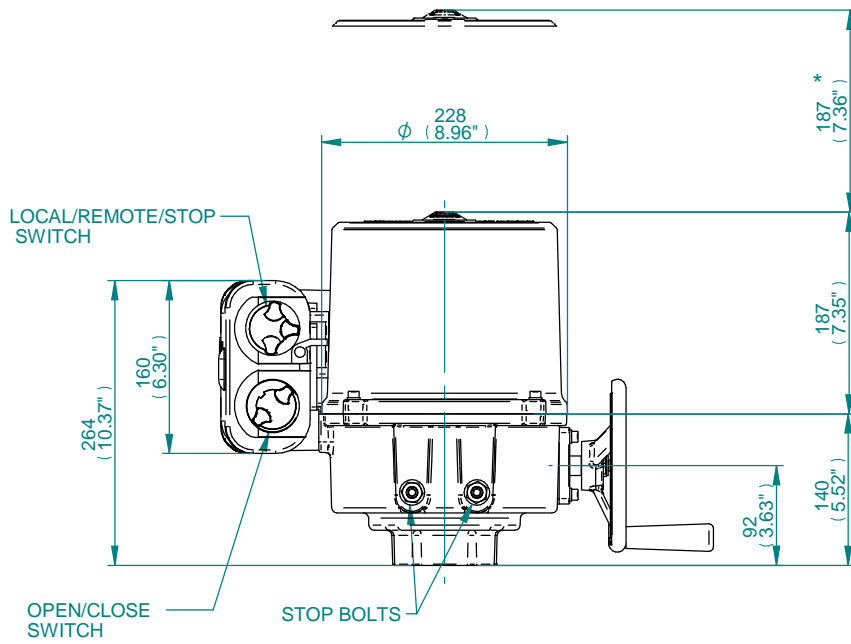
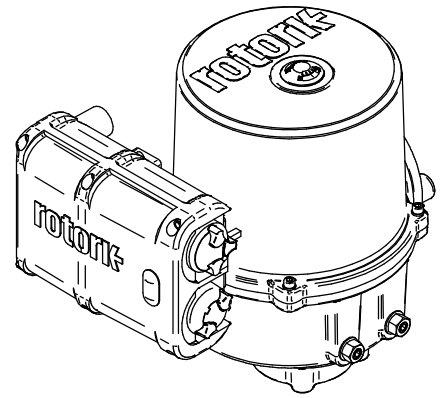
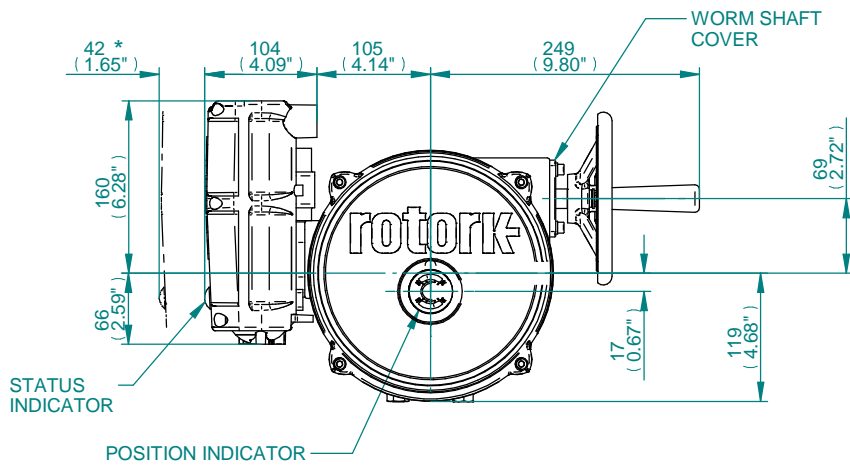

NOTES

*Removal allowance required.

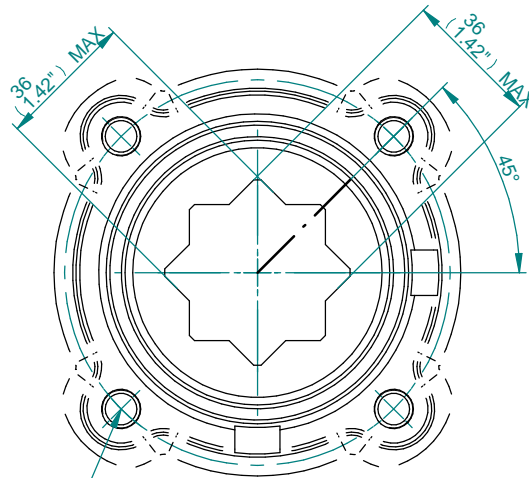
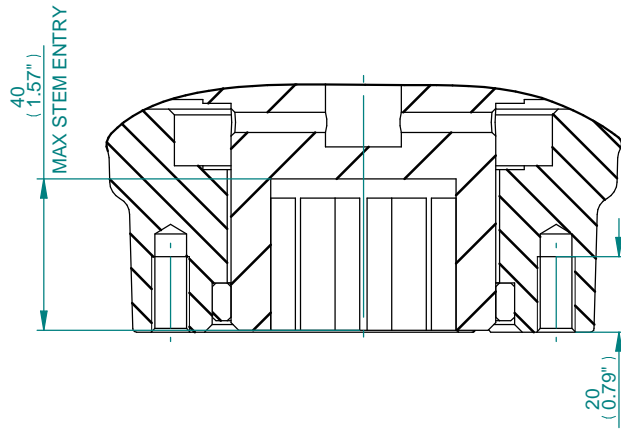

4 HOLES M10 x1.5p
EQUI-SPACED AS SHOEN
ON A102 PCD (ISO5211 F10)

ROMpak4,5,6 F10 Mounting Base Details