

rotork®

Keeping the World Flowing
for Future Generations

Solenoid Valves



m&m
International
A rotork® Brand

Reliability in critical flow control applications



› Reliable operation when it matters

Assured reliability for critical applications and environments. Whether used infrequently or continuously, Rotork products will operate reliably and efficiently.

› Quality-driven global manufacturing

We offer products that have been designed with over 60 years of industry and application knowledge. Our research and development ensures cutting edge products are available for multiple applications across multiple industries.

› Customer focused service and worldwide support

Rotork solve customer challenges and develop new solutions that are tailored to the needs of our clients. We offer dedicated, expert service and support from initial inquiry, to product installation, to long term after sales care.

› Low cost of ownership

Long-term reliability prolongs service life. Rotork helps to reduce long term cost of ownership and provides greater efficiency to process and plant.

Solenoid Valves

Section	Page	Section	Page
Instrumentation and control	4	DIN connectors for M&M branded solenoid valves	45
Introduction	5	Customised products	46
Product Index	6	Valve selection	48
Applications Index	9	Technical information	49
M&M solenoid valves	10	Valve installation	51
Solenoid valves for vacuum	39	Quality standards	52
Automatic drain valve systems with solenoid valves	41	Coding chart	53
Analogue electronic timer	42	Site Services	54
Coils for M&M branded solenoid valves	43		



Comprehensive product range serving multiple industries

Rotork products offer improved efficiency, assured safety and environmental protection across sectors such as the Power, Oil & Gas, Water & Wastewater, HVAC, Marine, Mining, Pulp & Paper, Food & Beverage, Pharmaceutical and Chemical sectors.

Market leaders and technical innovators

We have been the recognised market leader in flow control for over 60 years.

Our customers rely upon Rotork for innovative solutions to safely manage the flow of liquids, gases and powders.

Global presence, local service

We are a global company with local support.

Manufacturing sites, service centres and sales offices throughout the world provide unrivalled customer services, fast delivery and ongoing, accessible support.

Corporate social responsibility is at the heart of our business

We are socially, ethically and environmentally responsible and committed to embedding CSR across all our processes and ways of working.

Instrumentation and control



Rotork is a specialist manufacturer of products for flow control, pressure control, flow measurement and pressure measurement.

Our solutions are trusted wherever there is a need for high precision and reliability, including pharmaceutical, oil and gas, biomedical and manufacturing industries.

We have production facilities throughout the world, complemented by a large network of distribution and support centres.

A full listing of our worldwide sales and service network is available on our website at www.rotork.com



Worldwide Industry and Application Experience

With over 60 years of extensive knowledge and experience, Rotork has provided products and services worldwide for virtually every industrial actuator application.

Rotork offer a range of precision control and valve accessory products in partnership with our prestigious brands, including Fairchild, Soldo®, Midland-ACS™, Bifold®, M&M and Alcon:

Instrument Valves

- Valve actuation accessories
- Solenoid valves
- Piston valves
- Instrument valves
- Medium pressure valves
- Subsea valves and connectors

Controllers

- Valve positioners
- Rail systems
- I/P and E/P converters

Measurement

- Valve position sensors
- Transmitters and switches

Instrument Pumps

- Pumps
- Intensifiers and accumulators

Rotork is proud to offer a diverse range of products which serve many different duties in a wide variety of applications. We also offer a factory customisation service to create one-off units to meet specific needs.

Introduction



Rotork Italy are leading manufacturers of industrial solenoid valves, made under the M&M brand. Whether designing solutions for stand-alone valves or a customised OEM installation we have developed an enviable reputation for quality products, reliability and innovation.

With facilities based in Italy and sales offices worldwide, we can provide solenoid valves to operate a wide variety of applications anywhere in the world.

Our product line covers a full range of valves for general and special-purpose including:

- Air
- Water
- Steam
- Automation
- Actuation
- High Pressure
- Aggressive Media
- Vacuum

Our solenoid valves can be manufactured with coils and enclosures covered by UL to meet application demands.

The advantages of solenoid valves manufactured under the M&M brand include:





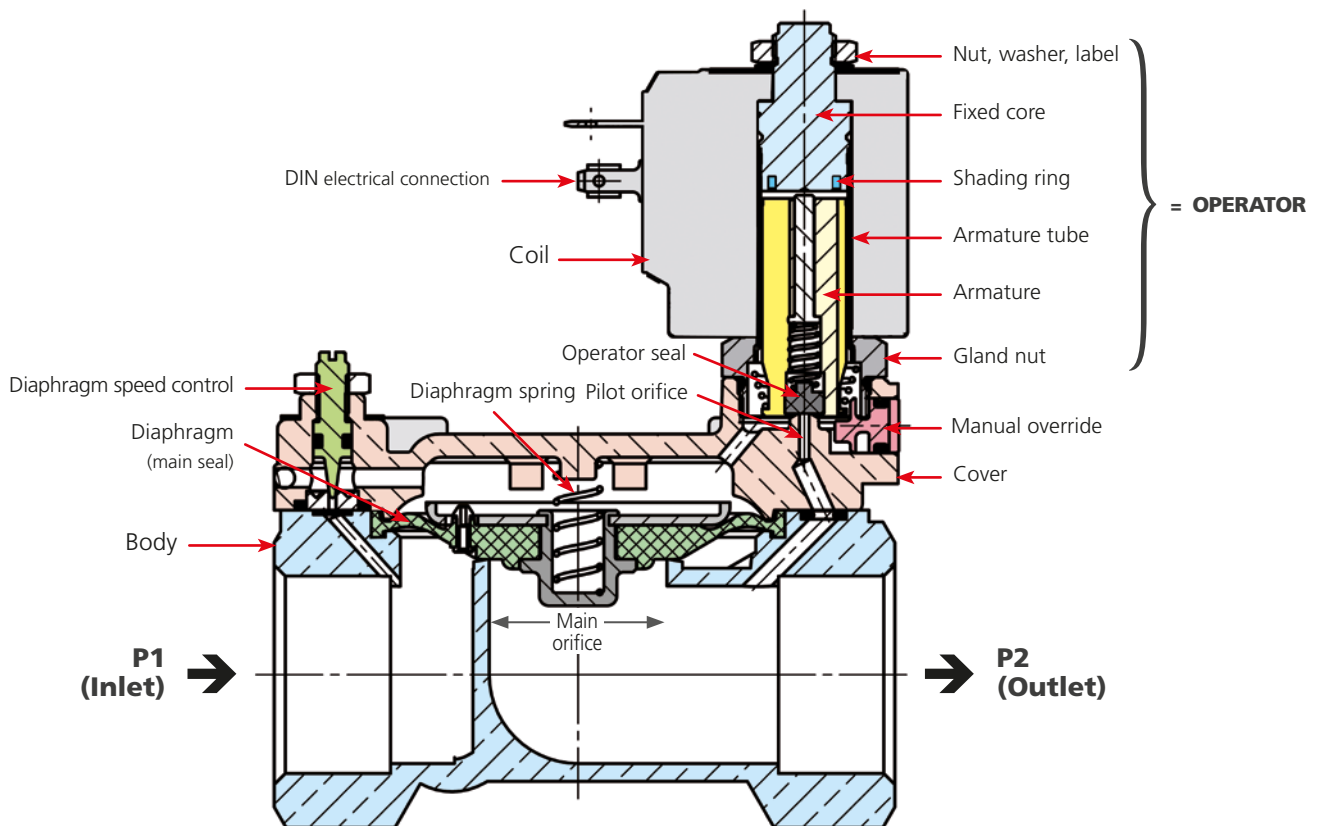







- Robust construction for industrial applications featuring stainless steel orifice on most models
- Stainless steel operators with low residual magnetism according to 1.4105 EN 10088 (AISI 430F)
- High quality seal materials
NBR, FKM, EPDM, PTFE, Sigodur (filled PTFE), Ruby, Kalrez®
- Fully interchangeable coils* with a wide range of AC and DC voltages. Coil orientation possible through 360°
- Coils tested 100% in compliance with the current EC directives compliance to RoHS directive and to relevant international standards upon request
- Development and realisation of special projects

*where applicable



Scheme of components of M&M International solenoid valves







Product Index





Valve	Code	Type of Connection	Page
	B298 - (2/2 way direct acting) Normally closed	G 1/8" to ISO 228-1	10
	D298/299 - (2/2 way direct acting) Normally closed	G 1/8" & 1/4" to ISO 228-1	11
	RD298/299 - (2/2 way direct acting) Normally open	G 1/8" & 1/4" to ISO 228-1	12
	B297 & RB297 - (2/2 way direct acting) Normally closed and normally open	G 1/8" to ISO 228-1	13
	D262/263 - (2/2 way direct acting) Normally closed	G 1/8" & 1/4" to ISO 228-1	14
	RD262/263 - (2/2 way direct acting) Normally open	G 1/8" & 1/4" to ISO 228-1	15
	D249 - (2/2 way direct acting) Normally closed	G 1/4" to ISO 228-1	16
	D237/238/239 - (2/2 way direct acting) Normally closed	G 1/4" to 1/2" to ISO 228-1	17
	D201 & RD201 - (2/2 way direct acting) Normally closed and normally open	Flange 32x32	18
	RB214 - (2/2 way direct acting) Normally open	G 1/8" to ISO 228-1	19
	RD213 - (2/2 way direct acting) Normally open	G 1/8" to ISO 228-1	20
	RD236 - (2/2 way direct acting) Normally open	G 1/4" to ISO 228-1	21

Product Index

Valve	Code	Type of Connection	Page
	B398- (3/2 way direct acting) Normally closed	G 1/8" to ISO 228-1	22
	D398/399 & RD398/399- (3/2 way direct acting) Normally closed and normally open	G 1/8" & 1/4" to ISO 228-1	23
	B397 & RB397 & SB397- (3/2 way direct acting) Normally closed and normally open	G 1/8" to ISO 228-1	24
	D362/363 & RD-SD-DD-GD362/363- (3/2 way direct acting) Normally closed and normally open	G 1/8" & 1/4" to ISO 228-1	25
	D301 & RD301- (3/2 way direct acting) Normally closed and normally open	Flange 32x32	27
	D884/885/886- (2/2 way pilot operated with assisted lift) Normally closed	G 1/4" to 1/2" to ISO 228-1	28
	D204 - 222 & RD204 - 222- (2/2 way pilot operated) Normally closed and normally open	G 3/8" to 1" to ISO 228-1	29
	B203 - B222 & RB203 - RB222- (2/2 way pilot operated) Normally closed and normally open	G 1/4" to 1" to ISO 228-1	30
	RSV01 (2/2 way pilot operated) Normally closed	G 1/4" to 1" to ISO 228-1	31
	RSV01 (2/2 way pilot operated) Normally open	G 1/4" to 1" to ISO 228-1	32
	D223 - D225 & RD223 - RD225- (2/2 way pilot operated) Normally closed and normally open	G 1 1/4" to 2" to ISO 228-1	33
	D264/265/266- (2/2 way pilot operated) Normally closed	G 1/4" to 1/2" to ISO 228-1	34

Product Index

Valve	Code	Type of Connection	Page
	D634 – D636- (2/2 way pilot operated) Normally closed	G 1/4" to 1/2" to ISO 228-1	35
	D232 – D234 & RD232 – RD234- (2/2 way pilot operated) Normally closed and normally open	G 3/8" to 3/4" to ISO 228-1	36
	D606 – D622 & RD606 – RD622 (2/2 way pilot operated) Normally closed and normally open	G 1/4" to 1/2" to ISO 228-1	37
	LC203 – LC205- (2/2 way latching) Normally closed	G 1/4" to 1/2" to ISO 228-1	38
	Various part numbers- (valves for vacuum)	–	39
	D211- (2/2 way dry armature) Normally closed	G 3/8" to ISO 228-1	40
	ADV- (compressed air)	with solenoid valves	41

Miscellaneous	Code	Description	Page
	AT2720	Analogue timers	42
	Series 2000 / 7000	Coils	43
	600 001- / 600 011-	Connectors	45
	Various part numbers	Customised products	46

Applications Index

General purpose

Direct acting

B298	10
D298/299	11
RD298/299	12
D262/263	14
RD262/263	15
RD236	21
B398	22
D398/399 / RD398-399	23
B397	24
D362/363 / RD362/363	25

Assisted lift

D884/885/886-	28
---------------------	----

Pilot operated

B203-22 / RB203-222	30
D223/224/225 / RD223/224/225	33
D264/265/266	34

Latching

LC203/204/205	38
---------------------	----

Automation

Direct acting

B297 / RB297	13
D237	17
D201 / RD201	18
SB397 / RB397	24
SD362/363 / DD362/363 / GD362/363	25
D301 / RD301	27

High pressure

Direct acting

D298/299DR-1	11
RD298/299DR	12
D262/263DR-1	14
RD201DR	18
RD236DR-1	21

Pilot operated

D634/365/636DTT1	35
D232/233/234DTW / RD232/233/234DTW	36

Steam

Direct acting

D262/263DL	14
D237/238/239DL	17
RD236DL	21
D398/399CL	23

Pilot operated

D634/365/636DTT	35
D606/622DTY / RD606/622DTY	37

Compressed air

Direct acting

D248/249	16
RB214	19
RD213	20

Pilot operated

D264/265/266	34
D232/233/234DVW	36
ADV with solenoid valves	41

Dry armature

D211DSU / C D211DSU	40
---------------------------	----

Chemical industry

B298	10
D298/299	11

Aggressive fluids

Pilot operated

D204-222 / RD204-222	29
----------------------------	----

Vacuum

Various part numbers	46
----------------------------	----

2/2 way direct acting solenoid valve, G 1/8"

Common features

Body material: stainless steel (1.4305 EN 10088/AISI 303)
 Orifice material: stainless steel (1.4305 EN 10088/AISI 303)
 Operator material: stainless steel
 Protection class: IP 65 (with connector and gasket)

TYPE: B298

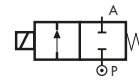

Normally Closed



Dimensions & weights		B298
G connection	[ISO 228]	1/8"
A	[mm]	35
B	[mm]	60.6
C	[mm]	18
D	[mm]	10
weight	[kg]	0.1

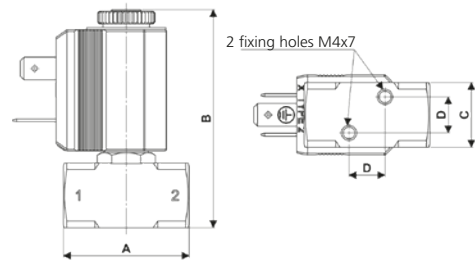

Flow direction overseat 1 → 2

General purpose

Valve code	Nominal Ø [mm]	Flow rate Kvs [l/min]	OPD			Coils	
			min. [barg]	max. AC [barg]	max. DC [barg]	code	[Volts/Hz]
B298DVC	1.5	1.3	0	22	18	2250	24 VDC
B298DVE	2.0	1.9	0	18	8	2200	24 V 50/60 Hz
B298DVG	2.5	2.7	0	13	2.5	2400	110 V 50 Hz - 120 V 60 Hz
B298DVH	3.0	3.5	0	8	1	2600	200 V 50 Hz - 220 V 60 Hz
						2700	230 V 50 Hz - 240 V 60 Hz

B298 - FKM seal, NC -

Media: water, oil, air and aggressive fluids
 Media temperature: -10 to +130 °C
 Ambient temperature: -10 to +50 °C
 Seal material: foodgrade FKM
 Coil power: AC 10 VA (holding)
 AC 16 VA (inrush)
 DC 7 W

Chemical industry

Valve code	Nominal Ø [mm]	Flow rate Kvs [l/min]	OPD			Coils	
			min. [barg]	max. AC [barg]	max. DC [barg]	code	[Volts/Hz]
B298DKC	1.5	1.3	0	24	24	2250	24 VDC
B298DKE	2.0	1.9	0	18	15	2200	24 V 50/60 Hz
B298DKG	2.5	2.7	0	15	3	2400	110 V 50 Hz - 120 V 60 Hz
						2600	200 V 50 Hz - 220 V 60 Hz
						2700	230 V 50 Hz - 240 V 60 Hz

B298 - Kalrez® seal, NC -

Media: chemicals
 Media temperature: -10 to +130 °C
 Ambient temperature: -10 to +50 °C
 Seal material: Kalrez® Spectrum™ 6375
 Coil power: AC 10 VA (holding)
 AC 16 VA (inrush)
 DC 7 W

Options

Protective treatment (e.g. code B298DKCE)

2/2 way direct acting solenoid valve, G 1/8" – G 1/4"

Common features

Body material: stainless steel (1.4305 EN 10088/AISI 303)
 Orifice material: stainless steel (1.4305 EN 10088/AISI 303)
 Operator material: stainless steel
 Protection class: IP 65 (with connector and gasket)

Options

Available with body thread connection 1/8" (e.g. code D298DVC), performance ratings remain the same as D299DVC.
 Silver shading ring (e.g. code D299DVC A)
 NPT connection on request, minimum batch may be required (e.g. code D299DVC N)

TYPE: D298/299

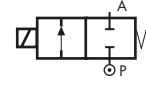

Normally Closed



Dimensions & weights		D298	D299
G connection	[ISO 228]	1/8"	1/4"
A	[mm]	45	45
B	[mm]	80	80
C	[mm]	12.5	12.5
D	[mm]	15.4	15.4
weight	[kg]	0.36	0.36

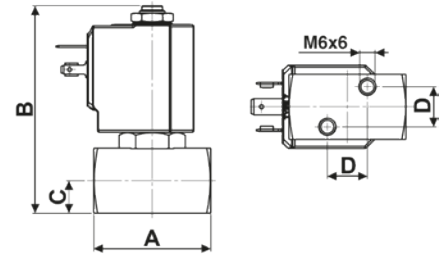

Flow direction overseat 1 → 2

General purpose

Valve	Nominal Ø	Flow rate Kvs	OPD			Coils	
			min.	max. AC	max. DC	code	[Volts/Hz]
code	[mm]	[l/min]	[barg]	[barg]	[barg]	code	[Volts/Hz]
D299DVC	1.5	1.2	0	24	24	7250	24 VDC
D299DVG	2.5	3.3	0	18	18	7200	24 V 50/60 Hz
D299DVH	3.0	4.5	0	15	10	7400	110 V 50 Hz - 120 V 60 Hz
D299DVL	4.0	6.0	0	10	5.5	7600	200 V 50 Hz - 220 V 60 Hz
D299DVN	5.0	7.5	0	5	2.5	7700	230 V 50 Hz - 240 V 60 Hz

D298/299 - FKM seal, NC -

Media: water, oil, air and aggressive fluids
 Media temperature: -10 to +130 °C
 Ambient temperature: -10 to +50 °C
 Seal material: foodgrade FKM
 Coil power: AC 18 VA (holding)
 AC 36 VA (inrush)
 DC 14 W

Options

EPDM seal, temperature max. 120 °C
 (e.g. code D298DEH)

Chemical industry

Valve	Nominal Ø	Flow rate Kvs	OPD			Coils	
			min.	max. AC	max. DC	code	[Volts/Hz]
code	[mm]	[l/min]	[barg]	[barg]	[barg]	code	[Volts/Hz]
D299DKE	2.0	2.3	0	20	20	7250	24 VDC
D299DKG	2.5	3.3	0	18	16	7200	24 V 50/60 Hz
D299DKH	3.0	4.5	0	15	8	7400	110 V 50 Hz - 120 V 60 Hz
						7600	200 V 50 Hz - 220 V 60 Hz
						7700	230 V 50 Hz - 240 V 60 Hz

D298/299 - KALREZ® seal, NC -

Media: chemicals
 Media temperature: -10 to +130 °C
 Ambient temperature: -10 to +50 °C
 Seal material: Kalrez® Spectrum™ 6375
 Coil power: AC 18 VA (holding)
 AC 36 VA (inrush)
 DC 14 W

Options

Protective treatment (e.g. code D299DKEE)

High pressure

Valve	Nominal Ø	Flow rate Kvs	OPD			Coils high power - class 'H' only	
			min.	max. AC	max. DC	code	[Volts/ Hz]
code	[mm]	[l/min]	[barg]	[barg]	[barg]	code	[Volts/ Hz]
D299DRB1	1.2	0.7	0	200	110	7221	24 VDC
D299DRC1	1.5	1.2	0	200	80	72K1	24 V 50/60 Hz
D299DRE1	2.0	2.3	0	140	30	74K1	110 V 50 Hz - 120 V 60 Hz
D299DRG1	2.5	3.3	0	90	23	77K1	230 V 50 Hz - 240 V 60 Hz
D299DRH1	3.0	4.5	0	50	14		

D298/299 - RUBY seal, NC -

Media¹: water, oil, air and aggressive fluids
 Media temperature: -10 to +130 °C
 Ambient temperature: -10 to +50 °C
 Seal material: Ruby
 Coil power: AC 25 VA (holding)
 AC 50 VA (inrush)
 DC 22 W

Notes

Seamless tube as standard
¹ Not 100% leak-proof when used with air/gases.
 Approximate leak rate is 1,5 ml/min at max. OPD.

ATTENTION: When high pressure valves are supplied without a coil, their nameplates display the max. OPD of the valve when equipped with an AC (25 VA) and DC (22 W) coil (as shown in the table above). **When using alternative coil power ratings please ensure to request separately the appropriate nameplate at time of order.**

2/2 way direct acting solenoid valve, G 1/8" – G 1/4"

Common features

Body material: stainless steel (1.4305 EN 10088/AISI 303)
 Orifice material: stainless steel (1.4305 EN 10088/AISI 303)
 Operator material: stainless steel
 Protection class: IP 65 (with connector and gasket)

Options

Available with body thread connection 1/8" (e.g. code RD298DVA), performance ratings remain the same as RD299DVA
 Silver shading ring (e.g. code RD299DVCA)
 NPT connection on request, minimum batch may be required (e.g. code RD298DVG N)

Notes

Normally open version not available for orifice > Ø 3 mm
 Protective treatment of operators is recommended, minimum batch may be required

TYPE: RD298/299

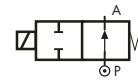

Normally Open



Dimensions & Weights		RD298	RD299
G connection	[ISO 228]	1/8"	1/4"
A	[mm]	45	45
B	[mm]	77.5	77.5
C	[mm]	12.5	12.5
D	[mm]	15.4	15.4
weight	[kg]	0.36	0.36

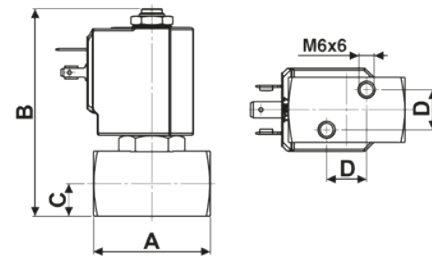

Flow direction overseat 1 → 2

General purpose

Valve code	Nominal Ø [mm]	Flow rate Kvs [l/min]	OPD			Coils class 'H' only normally closed and normally open	
			min. [barg]	max. AC [barg]	max. DC [barg]	code	[Volts/ Hz]
RD299DVA	1.0	0.6	0	30	30	7251	24 VDC
RD299DVG	2.5	3.3	0	14	14	7201	24 V 50/60 Hz
RD299DVH	3.0	4.5	0	9	9	7401	110 V 50 Hz - 120 V 60 Hz
						7601	200 V 50 Hz - 220 V 60 Hz
						7701	230 V 50 Hz - 240 V 60 Hz

RD298/299 - FKM seal, NO -

Media: water, oil, air and aggressive fluids
 Media temperature: -10 to +130 °C
 Ambient temperature: -10 to +50 °C
 Seal material: foodgrade FKM
 Coil power: AC 18 VA (holding)
 AC 36 VA (inrush)
 DC 14 W

Options

EPDM seal, temperature max. 120 °C
 (e.g. code RD299DEG)

High pressure

Valve code	Nominal Ø [mm]	Flow rate Kvs [l/min]	OPD			Coils class 'H' only normally closed and normally open	
			min. [barg]	max. AC [barg]	max. DC [barg]	code	[Volts/ Hz]
RD299DRA	1.0	0.6	0	100	100	7251	24 VDC
RD299DRB	1.2	0.7	0	85	85	7201	24 V 50/60 Hz
RD299DRC	1.5	1.2	0	55	55	7401	110 V 50 Hz - 120 V 60 Hz
RD299DRE	2.0	2.3	0	25	25	7601	200 V 50 Hz - 220 V 60 Hz
RD299DRG	2.5	3.3	0	19	19	7701	230 V 50 Hz - 240 V 60 Hz
RD299DRH	3.0	4.5	0	10	10		

RD298/299 - RUBY SEAL, NO -

Media: water and liquids
 Media temperature: -10 to +130 °C
 Ambient temperature: -10 to +50 °C
 Seal material: Ruby
 Coil power: AC 18 VA (holding)
 AC 36 VA (inrush)
 DC 14 W

Notes

² Not 100% leak-proof when used with air/gases.
 Approximate leak rate is 1,5 ml/min at max. OPD.

2/2 way direct acting solenoid valve, G 1/8"

Common features

Media¹: water, oil, air
 Media temperature: -10 to +130 °C
 Ambient temperature: -10 to +50 °C
 Body material: brass (CW719R EN 12165) low lead content
 Orifice material: stainless steel (1.4305 EN 10088/AISI 303)
 Operator material: stainless steel
 Seal material: foodgrade FKM
 Protection class: IP 65 (with connector and gasket)

Options

EPDM seal, temperature max. 120 °C (e.g. code RB297DEC)
 NPT connection on request, minimum batch may be required (e.g. code RB297DVCN)

Notes

¹ Valve suitable for contact with food media as per the EEC Directives and Regulations.
 For more specific information, please contact Rotork Sales Department.

Dimensions & weights		B297	RB297
G connection	[ISO 228]	1/8"	1/8"
A	[mm]	30	30
B	[mm]	65	67.5
C	[mm]	18	18
D	[mm]	7	7
weight	[kg]	0.15	0.15

Automation

Valve code	Nominal Ø [mm]	Flow rate Kvs [l/min]	OPD			Coils	
			min. [barg]	max. AC [barg]	max. DC [barg]	code	[Volts/Hz]
B297DVA	1.0	0.5	0	30	28	2250	24 VDC
B297DVB	1.2	0.7	0	25	22	2200	24 V 50/60 Hz
B297DVC	1.5	1.0	0	22	18	2400	110 V 50 Hz - 120 V 60 Hz
B297DVE	2.0	1.7	0	18	9	2600	200 V 50 Hz - 220 V 60 Hz
B297DVG	2.5	2.3	0	13	3	2700	230 V 50 Hz - 240 V 60 Hz
B297DVH	3.0	3.0	0	8	1		

Automation

Valve code	Nominal Ø [mm]	Flow rate Kvs [l/min]	OPD			Coils	
			min. [barg]	max. AC [barg]	max. DC [barg]	code	[Volts/Hz]
RB297DVA	1.0	0.5	0	25	25	2250 ¹	24 VDC
RB297DVB	1.2	0.7	0	20	20	2200	24 V 50/60 Hz
RB297DVC	1.5	1.0	0	15	15	2400	110 V 50 Hz - 120 V 60 Hz
RB297DVE	2.0	1.7	0	10	10	2600	200 V 50 Hz - 220 V 60 Hz
RB297DVG	2.5	2.3	0	5	5	2700	230 V 50 Hz - 240 V 60 Hz
RB297DVH	3.0	3.0	0	4.5	4.5		

¹ For continuous service in DC we recommend the use of M&M coils 10 Watt, class H (see options on page 43)

TYPE: B297

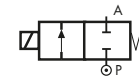

Normally Closed

TYPE: RB297

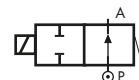

Normally Open

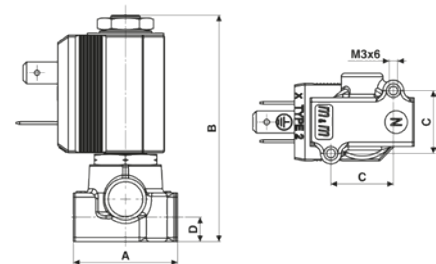

Flow direction overseat 1 → 2

B297 - FKM seal, NC -

Coil power: AC 10 VA (holding)
 AC 16 VA (inrush)
 DC 7 W

Options

Manual override (e.g. code B297DVCM)
 Electroless nickel plating treatment (e.g. code B297DVEK)

RB297 - FKM seal, NO -

Coil power: AC 10 VA (holding)
 AC 16 VA (inrush)
 DC 7 W

2/2 way direct acting solenoid valve, G 1/8" – G 1/4"

Common features

Body material: brass (CW617N EN 12165)
 Orifice material: stainless steel (1.4305 EN 10088/AISI 303)
 Operator material: stainless steel
 Protection class: IP 65 (with connector and gasket)

Options

Available with body thread connection 1/8" (e.g. code D262DVH), performance ratings remain the same as D263DVH.
 Manual override (e.g. code D262DVCM).

TYPE: D262/263

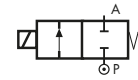

Normally Closed



Dimensions & Weights		D262	D263
G connection	[ISO 228]	1/8"	1/4"
A	[mm]	40	40
B	[mm]	77.5	77.5
C	[mm]	18.5	18.5
D	[mm]	9.5	9.5
weight	[kg]	0.26	0.26

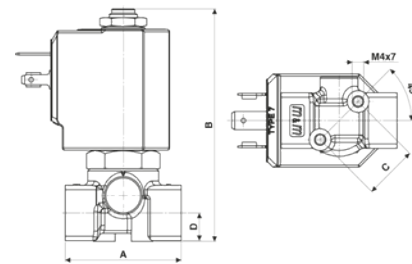

Flow direction overseat 1 → 2

General purpose

Valve code	Nominal Ø [mm]	Flow rate Kvs [l/min]	OPD			Coils	
			min. [barg]	max. AC [barg]	max. DC [barg]	code	[Volts/Hz]
D263DVA	1.0	0.5	0	30	30	7250	24 VDC
D263DYC	1.5	1.3	0	24	24	7200	24 V 50/60 Hz
D263DYG	2.5	3.4	0	18	16	7400	110 V 50 Hz - 120 V 60 Hz
D263DVH	3.0	4.5	0	15	10	7600	200 V 50 Hz - 220 V 60 Hz
D263DVL ¹	4.0	6.0	0	10	5	7700	230 V 50 Hz - 240 V 60 Hz
D263DVN ¹	5.0	7.5	0	5	2,5		
D263DVP ¹	6.0	8.0	0	3	1		

¹ Manual override not available for orifice > Ø 3 mm

D262/263 - FKM seal, NC -

Media: water, oil, air
 Media temperature: -10 to +130 °C
 Ambient temperature: -10 to +50 °C
 Seal material: foodgrade FKM
 Coil power: AC 18 VA (holding)
 AC 36 VA (inrush)
 DC 14 W

Options

EPDM seal, temperature max. 120 °C (e.g. code D262DEH)
 For vacuum see page 39

Steam

Valve code	Nominal Ø [mm]	Flow rate Kvs [l/min]	OPD			Coils class 'H' only	
			min. [barg]	max. AC [barg]	max. DC [barg]	code	[Volts/Hz]
D263DLA	1.0	0.5	0	9	9	7251	24 VDC
D263DLC	1.5	1.3	0	9	9	7201	24 V 50/60 Hz
D263DLG	2.5	3.4	0	9	8	7401	110 V 50 Hz - 120 V 60 Hz
D263DLH	3.0	4.5	0	9	5	7601	200 V 50 Hz - 220 V 60 Hz
						7701	230 V 50 Hz - 240 V 60 Hz

D262/263 - FILLED PTFE seal, NC -

Media: steam
 Media temperature: -10 to +180 °C
 Ambient temperature: -10 to +70 °C
 Seal material: Sigodur (filled PTFE)
 Coil power: AC 18 VA (holding)
 AC 36 VA (inrush)
 DC 14 W

Notes

Seamless tube as standard

High pressure

Valve code	Nominal Ø [mm]	Flow rate Kvs [l/min]	OPD			Coils high power - class 'H' only	
			min. [barg]	max. AC [barg]	max. DC [barg]	code	[Volts/Hz]
D263DRB1	1.2	0.7	0	200	60	7221	24 VDC
D263DRC1	1.5	1.3	0	200	35	72K1	24 V 50/60 Hz
D263DRE1	2.0	2.2	0	120	25	74K1	110 V 50 Hz - 120 V 60 Hz
D263DRH1	3.0	4.5	0	50	11	77K1	230 V 50 Hz - 240 V 60 Hz

D262/263 - RUBY seal, NC -

Media: water, oil, liquids
 Media temperature: -10 to +130 °C
 Ambient temperature: -10 to +50 °C
 Seal material: Ruby
 Coil power: AC 25 VA (holding)
 AC 50 VA (inrush)
 DC 22 W

Notes

Seamless tube as standard

² Not 100% leak-proof when used with air/gases.
 Approximate leak rate is 1,5 ml/min at max. OPD.

ATTENTION: When high pressure valves are supplied without a coil, their nameplates display the max. OPD of the valve when equipped with an AC (25 VA) and DC (22 W) coil (as shown in the table above). **When using alternative coil power ratings please ensure to request separately the appropriate nameplate at time of order.**

2/2 way direct acting solenoid valve, G 1/8" – G 1/4"

Common features

Body material: brass (CW617N EN 12165)
 Orifice material: stainless steel (1.4305 EN 10088/AISI 303)
 Operator material: stainless steel
 Protection class: IP 65 (with connector and gasket)

Options

Available with body thread connection 1/8" (e.g. code RD262DVA), performance ratings remain the same as RD263DVA.
 For steam version with filled PTFE seal (Sigodur) see valve model **RD236DL-** on page 21
 For high pressure version with Ruby seal see valve model **RD236DR-1** on page 21

TYPE: RD262/263

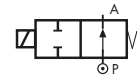

Normally Open



Dimensions & Weights		RD262	RD263
G connection	[ISO 228]	1/8"	1/4"
A	[mm]	40	40
B	[mm]	77.7	77.7
C	[mm]	18.5	18.5
D	[mm]	9.5	9.5
weight	[kg]	0.26	0.26

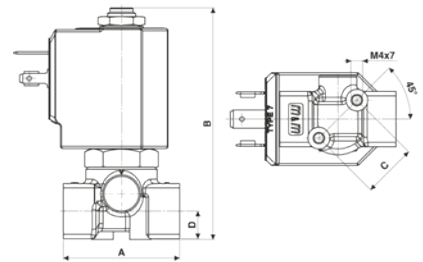

Flow direction overseat 1 → 2

General purpose

Valve code	Nominal Ø [mm]	Flow rate Kvs [l/min]	OPD			Coils class 'H' only	
			min. [barg]	max. AC [barg]	max. DC [barg]	code	[Volts/Hz]
RD263DVA	1.0	0.5	0	30	30	7251	24 VDC
RD263DVC	1.5	1.3	0	24	24	7201	24 V 50/60 Hz
RD263DVG	2.5	3.4	0	16	16	7401	110 V 50 Hz - 120 V 60 Hz
RD263DVH	3.0	4.5	0	10	10	7601	200 V 50 Hz - 220 V 60 Hz
						7701	230 V 50 Hz - 240 V 60 Hz

RD262/263 - FKM seal, NO -

Media: water, oil, air
 Media temperature: -10 to +130 °C
 Ambient temperature: -10 to +50 °C
 Seal material: foodgrade FKM
 Coil power: AC 18 VA (holding)
 AC 36 VA (inrush)
 DC 14 W

Options

EPDM seal, temperature max. 120 °C (e.g. code RD262DEH)

2/2 way direct acting solenoid valve, G 1/4"

Common features

Media: water, oil, air
 Media temperature: -10 to +130 °C
 Ambient temperature: -10 to +50 °C
 Body material: brass (CW617N EN 12165)
 Operator material: stainless steel
 Protection class: IP 65 (with connector and gasket)

TYPE: D249

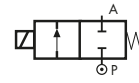

Normally Closed



Dimensions & Weights		D249
G connection	[ISO 228]	1/4"
A	[mm]	38
B	[mm]	72.1
C	[mm]	13
D	[mm]	13.8
weight	[kg]	0.18

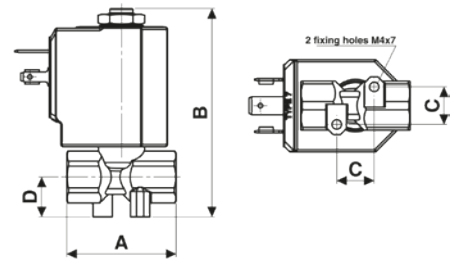

Flow direction overseat 1 → 2

Compressed air

Valve code	Nominal Ø [mm]	Flow rate Kvs [l/min]	OPD			Coils	
			min. [barg]	max. AC [barg]	max. DC [barg]	code	[Volts/Hz]
D249DVD	1.7	1.5	0	25	24	7250	24 VDC
D249DVF	2.2	2.4	0	18	16	7200	24 V 50/60 Hz
D249DVH*	3.0	4.5	0	15	10	7400	110 V 50 Hz - 120 V 60 Hz
						7600	200 V 50 Hz - 220 V 60 Hz
						7700	230 V 50 Hz - 240 V 60 Hz

* Minimum batch may be required

D249 - FKM seal, NC -

Seal material: FKM
 Coil power: AC 18 VA (holding)
 AC 36 VA (inrush)
 DC 14 W

Options

EPDM seal, temperature max. 120 °C (e.g. code D249DEF)

2/2 way direct acting solenoid valve, G 1/4" – G 1/2"

Common features

Body material: brass (CW617N EN 12165)
 Operator material: stainless steel
 Protection class: IP 65 (with connector and gasket)

TYPE: D237/238/239

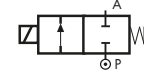

Normally Closed



Dimensions & Weights		D237	D238	D239
G connection	[ISO 228]	1/4"	3/8"	1/2"
A	[mm]	54	54	54
B	[mm]	89	89	89
C	[mm]	Hex 27	Hex 27	Hex 27
D	[mm]	15	15	15
weight	[kg]	0.45	0.4	0.4

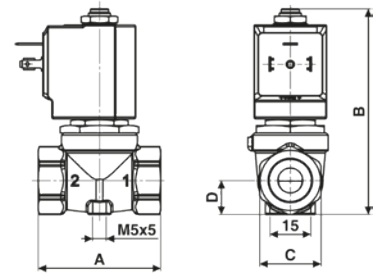

Flow direction overseat 1 → 2

Automation

Valve	Nominal Ø	Flow rate Kvs	OPD			Coils	
			min.	max. AC	max. DC	code	[Volts/Hz]
code	[mm]	[l/min]	[barg]	[barg]	[barg]	code	[Volts/Hz]
D237DVU	10.5	21	0	0.4	0.2	7250	24 VDC
D238DVU	10.5	25	0	0.4	0.2	7200	24 V 50/60 Hz
D239DVU	10.5	25	0	0.4	0.2	7400	110 V 50 Hz - 120 V 60 Hz
						7600	200 V 50 Hz - 220 V 60 Hz
						7700	230 V 50 Hz - 240 V 60 Hz

D237/238/239DVU - FKM seal, NC -

Media: water, oil, air
 Media temperature: -10 to +130 °C
 Ambient temperature: -10 to +50 °C
 Seal material: FKM
 Coil power: AC 18 VA (holding)
 AC 36 VA (inrush)
 DC 14 W

Options

NBR seal, temperature max. 90 °C (e.g. code D237DBU)
 EPDM seal, temperature max. 120 °C (e.g. code D239DEU)

Automation

Valve	Nominal Ø	Flow rate Kvs	OPD			Coils	
			min.	max. AC	max. DC	code	[Volts/Hz]
code	[mm]	[l/min]	[barg]	[barg]	[barg]	code	[Volts/Hz]
D238DYL	4.0	6	0	8	5	7250	24 VDC
D238DYN	5.0	7.5	0	5	2	7200	24 V 50/60 Hz
D238DYP	6.0	8.5	0	3.5	1.1	7400	110 V 50 Hz - 120 V 60 Hz
D239DVH	3.0	4.5	0	17	12	7600	200 V 50 Hz - 220 V 60 Hz
D239DYL	4.0	6	0	8	5	7700	230 V 50 Hz - 240 V 60 Hz
D239DYN	5.0	7.5	0	5	2		
D239DYP	6.0	8.5	0	3.5	1.1		

D238/239 - FKM seal, NC -

Media: water, oil, air
 Media temperature: -10 to +130 °C
 Ambient temperature: -10 to +50 °C
 Orifice material: stainless steel (1.4305 EN 10088/AISI 303)
 Seal material: FKM
 Coil power: AC 18 VA (holding)
 AC 36 VA (inrush)
 DC 14 W

Options

NBR seal, temperature max. 90 °C (e.g. code D239DBP)
 EPDM seal, temperature max. 120 °C (e.g. code D238DEP)

Notes

Same operator as D262/263DL-

Steam

Valve	Nominal Ø	Flow rate Kvs	OPD			Coils class 'H' only	
			min.	max. AC	max. DC	code	[Volts/Hz]
code	[mm]	[l/min]	[barg]	[barg]	[barg]	code	[Volts/Hz]
D238DLH	3.0	4.5	0	9	8	7251	24 VDC
D238DLN	5.0	7.5	0	5	2	7201	24 V 50/60 Hz
D239DLI	3.5	5.0	0	9	5	7401	110 V 50 Hz - 120 V 60 Hz
						7601	200 V 50 Hz - 220 V 60 Hz
						7701	230 V 50 Hz - 240 V 60 Hz

D238/239 - FILLED PTFE seal, NC -

Media: steam
 Media temperature: -10 to +180 °C
 Ambient temperature: -10 to +70 °C
 Orifice material: stainless steel (1.4305 EN 10088/AISI 303)
 Seal material: Sigodur (filled PTFE)
 Coil power: AC 18 VA (holding)
 AC 36 VA (inrush)
 DC 14 W

Notes

Seamless tube as standard
 Same operator as D262/263DL-

2/2 way direct acting solenoid valve, flange 32x32

Common features

Body material: brass (CW617N EN 12165)
 Orifice material: stainless steel (1.4305 EN 10088/AISI 303)
 Operator material: stainless steel
 Protection class: IP 65 (with connector and gasket)

TYPE: D201

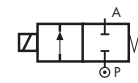

Normally Closed

TYPE: RD201

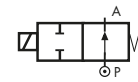

Normally Open



Dimensions & Weights		D201	RD201
G connection	[ISO 228G]	/	/
A	[mm]	∅ 32	∅ 32
B	[mm]	70.6	68.4
C	[mm]	24	24
D	[mm]	10.25	10.25
weight	[kg]	0.25	0.3

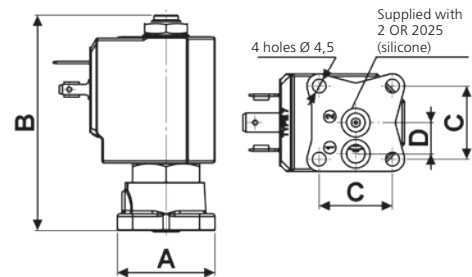

Flow direction overseat 1 → 2

Automation

Valve code	Nominal Ø [mm]	Flow rate Kvs [l/min]	OPD			Coils	
			min. [barg]	max. AC [barg]	max. DC [barg]	code	[Volts/Hz]
D201DVC	1.5	1.3	0	24	24	7250	24 VDC
D201DVE	2.0	2.2	0	20	20	7200	24 V 50/60 Hz
D201DVG	2.5	3.4	0	18	18	7400	110 V 50 Hz - 120 V 60 Hz
D201DVH	3.0	4.5	0	15	10	7600	200 V 50 Hz - 220 V 60 Hz
						7700	230 V 50 Hz - 240 V 60 Hz

D201 - FKM seal, NC -

Media: water, oil, air
 Media temperature: -10 to +130 °C
 Ambient temperature: -10 to +50 °C
 Seal material: foodgrade FKM
 Coil power: AC 18 VA (holding)
 AC 36 VA (inrush)
 DC 14 W

Options

EPDM seal, temperature max. 120 °C (e.g. code D201DEC)
 Manual override (e.g. code D201DVGGM)

Automation

Valve code	Nominal Ø [mm]	Flow rate Kvs [l/min]	OPD			Coils class 'H' only	
			min. [barg]	max. AC [barg]	max. DC [barg]	code	[Volts/Hz]
RD201DVC	1.5	1.3	0	24	24	7251	24 VDC
RD201DVG	2.5	3.4	0	16	16	7201	24 V 50/60 Hz
RD201DVH	3.0	4.5	0	10	10	7401	110 V 50 Hz - 120 V 60 Hz
						7601	200 V 50 Hz - 220 V 60 Hz
						7701	230 V 50 Hz - 240 V 60 Hz

RD201 - FKM seal, NO -

Media: water, oil, air
 Media temperature: -10 to +130 °C
 Ambient temperature: -10 to +50 °C
 Seal material: foodgrade FKM
 Coil power: AC 18 VA (holding)
 AC 36 VA (inrush)
 DC 14 W

Options

EPDM seal, temperature max. 120 °C (e.g. code RD201DEG)

High pressure

Valve code	Nominal Ø [mm]	Flow rate Kvs [l/min]	OPD			Coils class 'H' only	
			min. [barg]	max. AC [barg]	max. DC [barg]	code	[Volts/Hz]
RD201DRC	1.5	1.3	0	55	55	7251	24 VDC
RD201DBE	2.0	2.2	0	25	25	7201	24 V 50/60 Hz
RD201DBH	3.0	4.5	0	10	10	7401	110 V 50 Hz - 120 V 60 Hz
						7601	200 V 50 Hz - 220 V 60 Hz
						7701	230 V 50 Hz - 240 V 60 Hz

RD201 - RUBY seal, NO -

Media: water, oil, liquids
 Media temperature: -10 to +130 °C
 Ambient temperature: -10 to +50 °C
 Seal material: Ruby
 Coil power: AC 18 VA (holding)
 AC 36 VA (inrush)
 DC 14 W

Notes

¹ Not 100% leak-proof when used with air/gases.
 Approximate leak rate is 1,5 ml/min at max. OPD

2/2 way direct acting solenoid valve, G 1/8"

Common features

Media: water, oil, air
 Media temperature: -10 to +130 °C
 Ambient temperature: -10 to +50 °C
 Body material: brass (CW617N EN 12165)
 Operator material: stainless steel
 Protection class: IP 65 (with connector and gasket)

TYPE: RB214

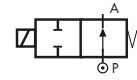

Normally Open



Dimensions & Weights		RB214
G connection	[ISO 228]	1/8"
A	[mm]	21
B	[mm]	66.5
C	[mm]	1/8"
D	[mm]	9.5
weight	[kg]	0.06

Compressed air

Valve code	Nominal Ø [mm]	Flow rate Kvs [l/min]	OPD			Coils	
			min. [barg]	max. AC [barg]	max. DC [barg]	code	[Volts/Hz]
RB214CVD	1.7	1.2	0	14	14	2250	24 VDC
						2200	24 V 50/60 Hz
						2400	110 V 50 Hz - 120 V 60 Hz
						2600	200 V 50 Hz - 220 V 60 Hz
						2700	230 V 50 Hz - 240 V 60 Hz

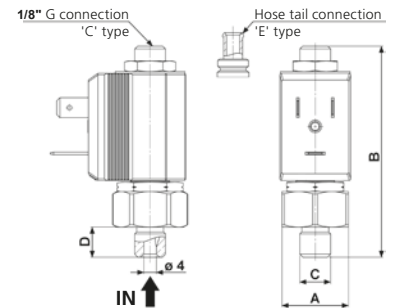

RB214 - FKM seal, NO -

Seal material: foodgrade FKM
 Coil power: AC 10 VA (holding)
 AC 16 VA (inrush)
 DC 7 W

Options

Armature tube with hose tail Ø 6 mm (e.g. code RB214EVD)
 EPDM seal, temperature max. 120 °C (e.g. code RB214CED)

2/2 way direct acting solenoid valve, G 1/8"

Common features

Media: water, oil, air
 Media temperature: -10 to +130 °C
 Ambient temperature: -10 to +50 °C
 Body material: brass (CW617N EN 12165)
 Operator material: stainless steel
 Protection class: IP 65 (with connector and gasket)

TYPE: RD213

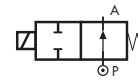

Normally Open



Dimensions & Weights		RD213
G connection	[ISO 228]	1/8"
A	[mm]	Hex 26
B	[mm]	82.5
C	[mm]	4
D	[mm]	9.5
weight	[kg]	0.1

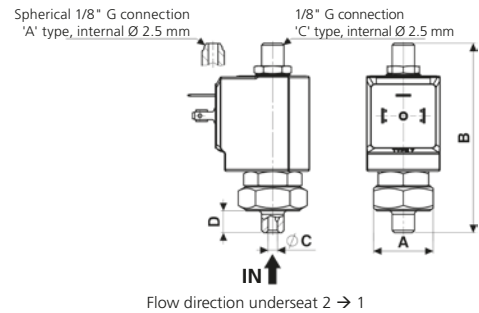

Flow direction underseat 2 → 1

Compressed air

Valve code	Nominal Ø [mm]	Flow rate Kvs [l/min]	OPD			Coils	
			min. [barg]	max. AC [barg]	max. DC [barg]	code	[Volts/Hz]
RD213CVG	2.5	2.4	0	16	16	7250	24 VDC
						7200	24 V 50/60 Hz
						7400	110 V 50 Hz - 120 V 60 Hz
						7600	200 V 50 Hz - 220 V 60 Hz
						7700	230 V 50 Hz - 240 V 60 Hz

RD213 - FKM seal, NO -

Seal material: foodgrade FKM
 Coil power: AC 18 VA (holding)
 AC 36 VA (inrush)
 DC 14 W

Options

EPDM seal, temperature max. 120 °C (e.g. code RD213CEG)
 Armature tube with spherical 1/8" G connection (e.g. code RD213ΔVG)

2/2 way direct acting solenoid valve, G 1/4"

Common features

Body material: brass (CW617N EN 12165)
 Orifice material: stainless steel (1.4305 EN 10088/AISI 303)
 Operator material: stainless steel
 Protection class: IP 65 (with connector and gasket)

TYPE: RD236

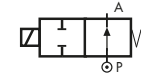

Normally Open



Dimensions & Weights		RD236
G connection	[ISO 228]	1/4"
A	[mm]	47*
B	[mm]	91
C	[mm]	Hex 22
D	[mm]	20.75
weight	[kg]	0.25

*Since July 2014

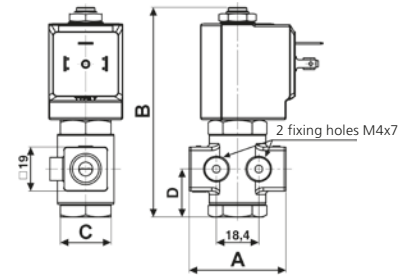

Flow direction overseat 1 → 2

General purpose

Valve code	Nominal Ø [mm]	Flow rate Kvs [l/min]	OPD			Coils	
			min. [barg]	max. AC [barg]	max. DC [barg]	code	[Volts/Hz]
RD236DVA	1.0	0.5	0	25	25	7250	24 VDC
RD236DVC	1.5	1.3	0	20	20	7200	24 V 50/60 Hz
RD236DVE	2.0	2.0	0	18	18	7400	110 V 50 Hz - 120 V 60 Hz
RD236DVG	2.5	2.8	0	15	15	7600	200 V 50 Hz - 220 V 60 Hz
RD236DVH	3.0	3.5	0	12	12	7700	230 V 50 Hz - 240 V 60 Hz
RD236DVM	4.5	5.5	0	5	5		
RD236DVP	6.0	8.5	0	2	2		

RD236 - FKM seal, NO -

Media: water, oil, air
 Media temperature: -10 to +130 °C
 Ambient temperature: -10 to +50 °C
 Seal material: foodgrade FKM
 Coil power: AC 18 VA (holding)
 AC 36 VA (inrush)
 DC 14 W

Steam

Valve code	Nominal Ø [mm]	Flow rate Kvs [l/min]	OPD			Coils class 'H' only	
			min. [barg]	max. AC [barg]	max. DC [barg]	code	[Volts/Hz]
RD236DLA	1.0	0.5	0	9	9	7251	24 VDC
RD236DLC	1.5	1.3	0	9	9	7201	24 V 50/60 Hz
RD236DLE	2.0	2.0	0	9	9	7401	110 V 50 Hz - 120 V 60 Hz
RD236DLH	3.0	3.5	0	9	9	7601	200 V 50 Hz - 220 V 60 Hz
						7701	230 V 50 Hz - 240 V 60 Hz

RD236 - FILLED PTFE seal, NO -

Media: steam
 Media temperature: -10 to +180 °C
 Ambient temperature: -10 to +70 °C
 Seal material: Sigodur (filled PTFE)
 Coil power: AC 18 VA (holding)
 AC 36 VA (inrush)
 DC 14 W

Notes

Seamless tube as standard

High pressure

Valve code	Nominal Ø [mm]	Flow rate Kvs [l/min]	OPD			Coils high power - class 'H' only	
			min. [barg]	max. AC [barg]	max. DC [barg]	code	[Volts/Hz]
RD236DRA1	1.0	0.5	0	180	180	7221	24 VDC
RD236DRC1	1.5	1.3	0	150	150	72K1	24 V 50/60 Hz
RD236DRE1	2.0	2.0	0	60	60	74K1	110 V 50 Hz - 120 V 60 Hz
RD236DRG1	2.5	2.8	0	37	37	77K1	230 V 50 Hz - 240 V 60 Hz
RD236DRH1	3.0	3.5	0	28	28		

RD236 - RUBY seal, NO -

Media¹: water, oil, liquids
 Media temperature: -10 to +130 °C
 Ambient temperature: -10 to +50 °C
 Seal material: Ruby
 Coil power: AC 25 VA (holding)
 AC 50 VA (inrush)
 DC 22 W

Notes

Seamless tube as standard

¹ Not 100% leak-proof when used with air/gases.
 Approximate leak rate is 1,5 ml/min at max. OPD.

3/2 way direct acting solenoid valve, G 1/8"

Common features

Media: water, oil, air and aggressive fluids
 Media temperature: -10 to +130 °C
 Ambient temperature: -10 to +50 °C
 Body material: stainless steel (1.4305 EN 10088/AISI 303)
 Orifice material: stainless steel (1.4305 EN 10088/AISI 303)
 Operator material: stainless steel
 Seal material: foodgrade FKM
 Protection class: IP 65 (with connector and gasket)

TYPE: B398

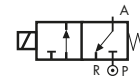

Normally Closed



Dimensions & weights		B398
G connection	[ISO 228]	1/8"
A	[mm]	35
B	[mm]	68
C	[mm]	18
D	[mm]	10
weight	[kg]	0.1

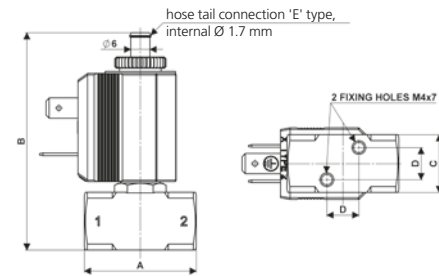

Flow direction underseat 2 → 1

General purpose

Valve code	Nominal Ø [mm]	Flow rate Kvs [l/min]	OPD			Coils	
			min. [barg]	max. AC [barg]	max. DC [barg]	code	[Volts/Hz]
B398EVB	1.2	0.7	0	15	15	2250	24 VDC
B398EVC	1.5	1.0	0	10	10	2200	24 V 50/60 Hz
B398EVE	2.0	1.9	0	5	5	2400	110 V 50 Hz - 120 V 60 Hz
B398EVG	2.5	2.7	0	3	3	2600	200 V 50 Hz - 220 V 60 Hz
						2700	230 V 50 Hz - 240 V 60 Hz

B398 - FKM seal, NC -

Coil power: AC 10 VA (holding)
 AC 16 VA (inrush)
 DC 7 W

3/2 way direct acting solenoid valve, G 1/8" – G 1/4"

Common features

Body material: stainless steel (1.4305 EN 10088/AISI 303)
 Orifice material: stainless steel (1.4305 EN 10088/AISI 303)
 Operator material: stainless steel
 Protection class: IP 65 (with connector and gasket)

Options

Available with body thread connection 1/8" (e.g. code D398DVC), performance ratings remain the same as D399DVC.
 NPT connection on request, minimum batch may be required (e.g. code RD399CVGN)

TYPE: D398/399



Normally Closed

TYPE: RD398/399

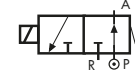

Normally Open



Dimensions & weights		D398	D399
G connection	[ISO 228]	1/8"	1/4"
A	[mm]	45	45
B	[mm]	87	87
C	[mm]	12.5	12.5
D	[mm]	15.4	15.4
weight	[kg]	0.35	0.35

General purpose

Valve	Nominal Ø	Flow rate Kvs	OPD			Coils	
			min.	max. AC	max. DC	code	[Volts/Hz]
code	[mm]	[l/min]	[barg]	[barg]	[barg]		
D399CVC	1.5	1.3	0	18	18	7250	24 VDC
D399CVE	2.0	2.2	0	10	10	7200	24 V 50/60 Hz
D399CVG	2.5	3.4	0	7	7	7400	110 V 50 Hz - 120 V 60 Hz
D399CVH	3.0	4.5	0	5	5	7600	200 V 50 Hz - 220 V 60 Hz
						7700	230 V 50 Hz - 240 V 60 Hz

1/8" G connection "C" type, internal Ø 2.5 mm

Spherical 1/8" G connection "A" type, internal Ø 2.5 mm

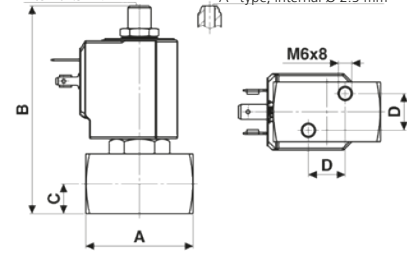

D398/399 - FKM seal, NC -

Media: water, oil, air and aggressive fluids
 Media temperature: -10 to +130 °C
 Ambient temperature: -10 to +50 °C
 Seal material: foodgrade FKM
 Coil power: AC 18 VA (holding)
 AC 36 VA (inrush)
 DC 14 W

Options

Armature tube with spherical 1/8" G connection (e.g. code D398AVC)
 Silver shading ring (e.g. code D398CVGA)
 UL approved coils (e.g. code 770B)

Steam

Valve	Nominal Ø	Flow rate Kvs	OPD			Coils class 'H' only	
			min.	max. AC	max. DC	code	[Volts/Hz]
code	[mm]	[l/min]	[barg]	[barg]	[barg]		
D399CLC	1.5	1.3	0	9	9	7251	24 VDC
D399CLE	2.0	2.2	0	9	9	7201	24 V 50/60 Hz
D399CLH	3.0	4.5	0	5	5	7401	110 V 50 Hz - 120 V 60 Hz
						7601	200 V 50 Hz - 220 V 60 Hz
						7701	230 V 50 Hz - 240 V 60 Hz

D398/399 - Sigodur seal, NC -

Media: steam
 Media temperature: -10 to +180 °C
 Ambient temperature: -10 to +70 °C
 Seal material: Sigodur (filled PTFE)
 Coil power: AC 18 VA (holding)
 AC 36 VA (inrush)
 DC 14 W

Options

Silver shading ring (e.g. code D398CLCA)

Notes

Seamless tube as standard

General purpose

Valve	Nominal Ø	Flow rate Kvs	OPD			Coils class 'H' only	
			min.	max. AC	max. DC	code	[Volts/Hz]
code	[mm]	[l/min]	[barg]	[barg]	[barg]		
RD399CVC	1.5	1.3	0	15	15	7251	24 VDC
RD399CVE	2.0	2.2	0	10	10	7201	24 V 50/60 Hz
RD399CVH	3.0	4.5	0	4	4	7401	110 V 50 Hz - 120 V 60 Hz
						7601	200 V 50 Hz - 220 V 60 Hz
						7701	230 V 50 Hz - 240 V 60 Hz

RD398/399 - FKM seal, NO -

Media: water, oil, air and aggressive fluids
 Media temperature: -10 to +130 °C
 Ambient temperature: -10 to +50 °C
 Seal material: foodgrade FKM
 Coil power: AC 18 VA (holding)
 AC 36 VA (inrush)
 DC 14 W

Notes

Protective treatment of operators is recommended, minimum batch may be required.

3/2 way direct acting solenoid valve, G 1/8"

Common features

Media¹: water, oil, air
 Media temperature: -10 to +130 °C
 Ambient temperature: -10 to +50 °C
 Body material: brass (CW719R EN 12165) low lead content
 Orifice material: stainless steel (1.4305 EN 10088/AISI 303)
 Operator material: stainless steel
 Seal material: foodgrade FKM
 Protection class: IP 65 (with connector and gasket)

Options

EPDM seal, temperature max. 120 °C (e.g. code RB397CEC)
 Electroless nickel plating treatment (e.g. code B397CVCK)

Notes

¹ Valve suitable for contact with food media as per the EEC Directives and Regulations.
 For more specific information, please contact Rotork Sales Department.

TYPE: SB397

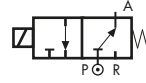

Normally Open

TYPE: B297



Normally Closed

TYPE: RB397

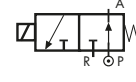

Normally Open



Dimensions & weights		B397	RB397	SB397
G connection	[ISO 228]	1/8"	1/8"	1/8"
A	[mm]	30	30	30
B	[mm]	67.8	72.5	67.8
C	[mm]	18	18	18
D	[mm]	7	7	7
weight	[kg]	0.15	0.16	0.15

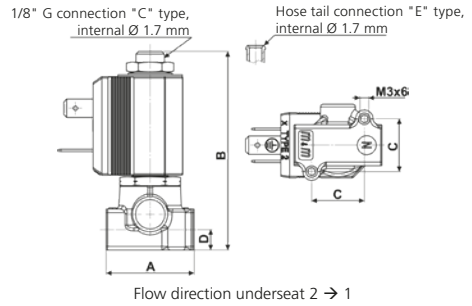

Flow direction underseat 2 → 1

General purpose

Valve code	Nominal Ø [mm]	Flow rate Kvs [l/min]	OPD			Coils	
			min. [barg]	max. AC [barg]	max. DC [barg]	code	[Volts/Hz]
B397CVA	1.0	0.5	0	18	18	2250	24 VDC
B397CVB	1.2	0.7	0	15	15	2200	24 V 50/60 Hz
B397CVC	1.5	1.0	0	10	10	2400	110 V 50 Hz - 120 V 60 Hz
B397CVE	2.0	1.9	0	5	5	2600	200 V 50 Hz - 220 V 60 Hz
B397CVH	3.0	3.5	0	2	2	2700	230 V 50 Hz - 240 V 60 Hz

B397 - FKM seal, NC

Coil power: AC 10 VA (holding)
 AC 16 VA (inrush)
 DC 7 W

Options

Manual override (e.g. code B397CVBM)
 Armature tube with hose tail Ø 6 mm (e.g. code B397EVE)
 UL approved coils (e.g. code 270R)

Automation

Valve code	Nominal Ø 1 → 2 1 → 3 [mm]		Flow rate Kvs [l/min]	OPD			Coils	
	[mm]	[mm]		min. [barg]	max. AC [barg]	max. DC [barg]	code	[Volts/Hz]
SB397CVB	1.2	1.7	0.7	0	6	3	2250	24 VDC
SB397CVC	1.5	1.7	1.0	0	4.5	2	2200	24 V 50/60 Hz
							2400	110 V 50 Hz - 120 V 60 Hz
							2600	200 V 50 Hz - 220 V 60 Hz
							2700	230 V 50 Hz - 240 V 60 Hz

SB397 - FKM seal, 2nd SERVICE -

Coil power: AC 10 VA (holding)
 AC 16 VA (inrush)
 DC 7 W

Options

Manual override (e.g. code SB397CVCM).

Notes

Flow direction: OFF 3 → 1 - ON 1 → 2

Automation

Valve code	Nominal Ø [mm]	Flow rate Kvs [l/min]	OPD			Coils	
			min. [barg]	max. AC [barg]	max. DC [barg]	code	[Volts/Hz]
RB397CVA	1.0	0.5	0	15	12	2250 ¹	24 VDC
RB397CVB	1.2	0.7	0	15	12	2200	24 V 50/60 Hz
RB397CVC	1.5	1.0	0	10	8	2400	110 V 50 Hz - 120 V 60 Hz
RB397CVE	2.0	1.9	0	8	6	2600	200 V 50 Hz - 220 V 60 Hz
RB397CVG	2.5	2.5	0	4	4	2700	230 V 50 Hz - 240 V 60 Hz
RB397CVH	3.0	3.5	0	3.5	3.5		

RB397 - FKM seal, NO

Coil power: AC 10 VA (holding)
 AC 16 VA (inrush)
 DC 7 W

¹ For continuous service in DC we recommend the use of M&M coils 10 Watt, class H (see options on page 43)

3/2 way direct acting solenoid valve, G 1/8" – G 1/4"

Common features

Media: water, oil, air
 Media temperature: -10 to +130 °C
 Ambient temperature: -10 to +50 °C
 Body material: brass (CW617N EN 12165)
 Orifice material: stainless steel (1.4305 EN 10088/AISI 303)
 Operator material: stainless steel
 Seal material: foodgrade FKM
 Protection class: IP 65 (with connector and gasket)

Options

Available with body thread connection 1/8" (e.g. code D362CVA), performance ratings remain the same as D363CVA.

NPT connection on request, minimum batch may be required (e.g. code RD363CVCN)

TYPE: D362/363



Normally Closed

TYPE: RD362/363



Normally Open



Dimensions & weights		D362	D363	RD362	RD363
G connection	[ISO 228]	1/8"	1/4"	1/8"	1/4"
A	[mm]	40	40	40	40
B	[mm]	87	87	87	87
C	[mm]	13	13	13	13
D	[mm]	9.5	9.5	9.5	9.5
weight	[kg]	0.26	0.26	0.26	0.26

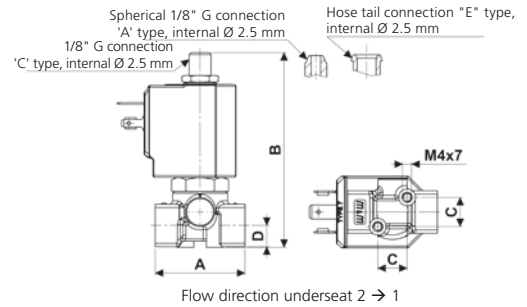

General purpose

Valve code	Nominal Ø [mm]	Flow rate Kvs [l/min]	OPD			Coils	
			min. [barg]	max. AC [barg]	max. DC [barg]	code	[Volts/Hz]
D363CVC	1.5	1.3	0	18	18	7250	24 VDC
D363CVE	2.0	2.2	0	10	10	7200	24 V 50/60 Hz
D363CVG	2.5	3.4	0	7	7	7400	110 V 50 Hz - 120 V 60 Hz
D363CVH	3.0	4.5	0	5	5	7600	200 V 50 Hz - 220 V 60 Hz
D363CVL ¹	4.0	6.0	0	3.5	3.5	7700	230 V 50 Hz - 240 V 60 Hz
D363CVN ¹	5.0	7.5	0	2.5	2.5		
D363CVP ¹	6.0	8.0	0	1.5	1.5		

¹ Manual override not available for orifice > Ø 3 mm

D362/363 - FKM seal, NC -

Coil power: AC 18 VA (holding)
 AC 36 VA (inrush)
 DC 14 W

Options

EPDM seal, temperature max. 120 °C (e.g. code D363CEC)
 Manual override (e.g. code D362CVGM)
 Armature tube with hose tail connection (e.g. code D362EVG)
 Armature tube with spherical 1/8" G connection (e.g. code D362AVC)
 For vacuum see page 39
 UL approved coils (e.g. code 770B)

General purpose

Valve code	Nominal Ø [mm]	Flow rate Kvs [l/min]	OPD			Coils class 'H' only	
			min. [barg]	max. AC [barg]	max. DC [barg]	code	[Volts/Hz]
RD363CVC	1.5	1.3	0	16	13	7251	24 VDC
RD363CVE	2.0	2.2	0	10	10	7201	24 V 50/60 Hz
RD363CVG	2.5	3.4	0	7	7	7401	110 V 50 Hz - 120 V 60 Hz
RD363CVH	3.0	4.5	0	4	4	7601	200 V 50 Hz - 220 V 60 Hz
						7701	230 V 50 Hz - 240 V 60 Hz

RD362/363 - FKM seal, NO -

Coil power: AC 18 VA (holding)
 AC 36 VA (inrush)
 DC 14 W

3/2 way direct acting solenoid valve, G 1/8" – G 1/4"

Common features

Media: water, oil, air
 Media temperature: -10 to +130 °C
 Ambient temperature: -10 to +50 °C
 Body material: brass (CW617N EN 12165)
 Orifice material: stainless steel (1.4305 EN 10088/AISI 303)
 Operator material: stainless steel
 Seal material: foodgrade FKM
 Protection class: IP 65 (with connector and gasket)

Options

Available with body thread connection 1/8" (e.g. code SD362CVC), performance ratings remain the same as SD363CVC.
 Armature tube with spherical 1/8" G connection (e.g. code SD362AVC)

TYPE: DD362/363

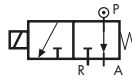

Normally Open - Diverting

TYPE: SD362/363

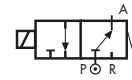

Normally Open - 2nd Service

TYPE: GD362/363

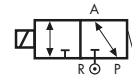

Universal Service



Dimensions & weights		SD362	SD363	DD362	DD363	GD362	GD363
G connection	[ISO 228]	1/8"	1/4"	1/8"	1/4"	1/8"	1/4"
A	[mm]	40	40	40	40	40	40
B	[mm]	87	87	87	87	87	87
C	[mm]	13	13	13	13	13	13
D	[mm]	9.5	9.5	9.5	9.5	9.5	9.5
weight	[kg]	0.26	0.26	0.26	0.26	0.26	0.26

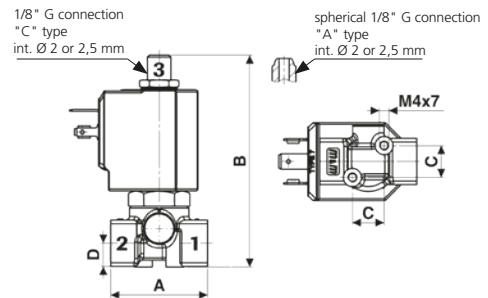

Automation

Valve code	Nominal Ø		Flow rate Kvs	OPD			Coils	
	1 → 2	1 → 3		min.	max. AC	max. DC	code	[Volts/Hz]
SD363CVC	1.5	1.5	1.3	0	15	15	7250	24 VDC
SD363CVE	2.0	2.0	2.2	0	15	15	7200	24 V 50/60 Hz
SD363CVG	2.5	2.5	3.4	0	13	13	7400	110 V 50 Hz - 120 V 60 Hz
							7600	200 V 50 Hz - 220 V 60 Hz
							7700	230 V 50 Hz - 240 V 60 Hz

SD362/363 - FKM seal, 2nd SERVICE -

Coil power: AC 18 VA (holding)
 AC 36 VA (inrush)
 DC 14 W

Notes
 Flow direction: OFF 3 → 1 - ON 1 → 2

Automation

Valve code	Nominal Ø		Flow rate Kvs	OPD			Coils	
	1 → 2	1 → 3		min.	max. AC	max. DC	code	[Volts/Hz]
DD363CVC	1.5	2.5	1.3	0	20	20	7250	24 VDC
DD363CVE	2.0	2.5	2.2	0	20	20	7200	24 V 50/60 Hz
							7400	110 V 50 Hz - 120 V 60 Hz
							7600	200 V 50 Hz - 220 V 60 Hz
							7700	230 V 50 Hz - 240 V 60 Hz

DD362/363 - FKM seal, DIVERTING -

Coil power: AC 18 VA (holding)
 AC 36 VA (inrush)
 DC 14 W

Notes
 Flow direction: OFF 1 → 3 - ON 1 → 2

Automation

Valve code	Nominal Ø		Flow rate Kvs	OPD			Coils	
	1 → 2	1 → 3		min.	max. AC	max. DC	code	[Volts/Hz]
GD363CVE	2.0	2.0	2.2	0	8	7	7250	24 VDC
							7200	24 V 50/60 Hz
							7400	110 V 50 Hz - 120 V 60 Hz
							7600	200 V 50 Hz - 220 V 60 Hz
							7700	230 V 50 Hz - 240 V 60 Hz

GD362/363 - FKM seal, UNIVERSAL SERVICE -

Coil power: AC 18 VA (holding)
 AC 36 VA (inrush)
 DC 14 W

Notes
 Pressure can be connected to all ports:
 • from 2 like D362,
 • from 1 like DD362,
 • from 3 like SD362.

3/2 way direct acting solenoid valve, flange 32x32

Common features

Media: water, oil, air
 Media temperature: -10 to +130 °C
 Ambient temperature: -10 to +50 °C
 Body material: brass (CW617N EN 12165)
 Orifice material: stainless steel (1.4305 EN 10088/AISI 303)
 Operator material: stainless steel
 Seal material: foodgrade FKM
 Protection class: IP 65 (with connector and gasket)

TYPE: D301

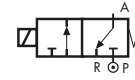

Normally Closed

TYPE: RD301

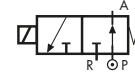

Normally Open



Dimensions & weights		D301	RD301
G connection	[ISO 228]	/	/
A	[mm]	∅ 32	∅ 32
B	[mm]	77	77.7
C	[mm]	24	24
D	[mm]	10.25	10.25
weight	[kg]	0.25	0.26

Automation

Valve code	Nominal ∅ [mm]	Flow rate Kvs [l/min]	OPD			Coils	
			min. [barg]	max. AC [barg]	max. DC [barg]	code	[Volts/Hz]
D301CVC	1.5	1.3	0	18	18	7250	24 VDC
D301CVE	2.0	2.2	0	10	10	7200	24 V 50/60 Hz
D301CVG	2.5	3.4	0	7	7	7400	110 V 50 Hz - 120 V 60 Hz
D301CVH	3.0	4.5	0	5	5	7600	200 V 50 Hz - 220 V 60 Hz
						7700	230 V 50 Hz - 240 V 60 Hz

Automation

Valve code	Nominal ∅ [mm]	Flow rate Kvs [l/min]	OPD			Coils class 'H' only	
			min. [barg]	max. AC [barg]	max. DC [barg]	code	[Volts/Hz]
RD301CVC	1.5	1.3	0	15	15	7251	24 VDC
RD301CVE	2.0	2.2	0	10	10	7201	24 V 50/60 Hz
RD301CVH	3.0	4.5	0	4	4	7401	110 V 50 Hz - 120 V 60 Hz
						7601	200 V 50 Hz - 220 V 60 Hz
						7701	230 V 50 Hz - 240 V 60 Hz

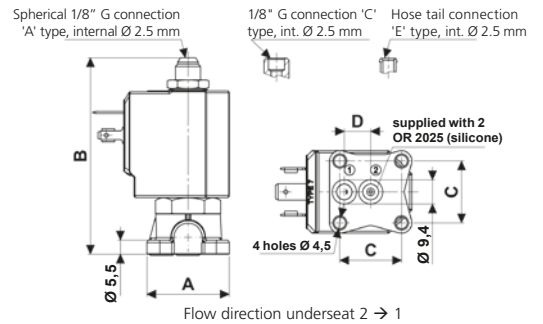

D301 - FKM seal, NC -

Coil power: AC 18 VA (holding)
 AC 36 VA (inrush)
 DC 14 W

Options

Armature tube with spherical 1/8" G connection (e.g. code D301AVE)
 Armature tube with hose tail connection (e.g. code D301EVC)
 Ruby seal for increased chemical resistance (e.g. code D301ABC)

RD301 - FKM seal, NO -

Coil power: AC 18 VA (holding)
 AC 36 VA (inrush)
 DC 14 W

2/2 way pilot operated solenoid valve with assisted lift, G 1/4" – G 1/2"

Common Features

Media: water, oil, air
 Media temperature: -10 to +130 °C
 Ambient temperature: -10 to +50 °C
 Body material: brass (CW617N EN 12165)
 Operator material: stainless steel
 Operator seal material: FKM
 Main seal and diaphragm material: FKM
 Protection class: IP 65 (with connector and gasket)

TYPE: D884/885/886

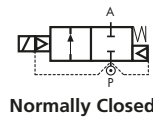

Dimensions & weights		D884	D885	D886
G connection	[ISO 228]	1/4"	3/8"	1/2"
A	[mm]	54	54	54
B	[mm]	89	89	89
C	[mm]	Hex 27	Hex 27	Hex 27
D	[mm]	15	15	15
weight	[kg]	0.45	0.4	0.4

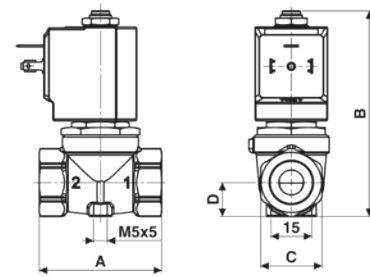

Flow direction overseat 1 → 2

General purpose

Valve code	Nominal Ø [mm]	Flow rate Kvs [l/min]	OPD			Coils	
			min. [barg]	max. AC [barg]	max. DC [barg]	code	[Volts/Hz]
D884DVU	10.5	21	0	16	6	7250	24 VDC
D885DVU	10.5	24	0	16	6	7200	24 V 50/60 Hz
D886DVU	10.5	25	0	16	6	7400	110 V 50 Hz - 120 V 60 Hz
						7600	200 V 50 Hz - 220 V 60 Hz
						7700	230 V 50 Hz - 240 V 60 Hz

D884/885/886 - FKM seal, NC -

Coil power: AC 18 VA (holding)
 AC 36 VA (inrush)
 DC 14 W

2/2 way pilot operated solenoid valve, G 3/8" – G 1"

Common features

Media: water, oil, air and aggressive fluids
 Media temperature: -10 to +130 °C
 Ambient temperature: -10 to +50 °C
 Body material: AISI 316L (ASME SA351/351M GRADE CF3M)
 Operator material: stainless steel
 Operator seal and diaphragm material: FKM
 Silver shading ring as standard
 Protection class: IP 65 (with connector and gasket)

Options

EPDM seal, temperature max. 120 °C (e.g. code D204DEZI)
 NBR seal, temperature max. 90 °C (e.g. code D206DZYI)
 NPT connection on request, minimum batch may be required (e.g. code D204DVZIN)

TYPE: D204–D222

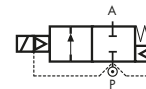

Normally Closed

TYPE: RD204–RD222

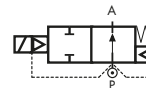

Normally Open



Dimensions & weights		D204	D205	D206	D222	RD204	RD205	RD206	RD222
G connection	[ISO 228]	3/8"	1/2"	3/4"	1"	3/8"	1/2"	3/4"	1"
A	[mm]	67	67	96	96	67	67	96	96
B	[mm]	102	102	125	125	100	100	123	123
C	[mm]	45.6	45.6	72	72	45.6	45.6	72	72
D	[mm]	15	15	24	24	15	15	24	24
weight	[kg]	0.49	0.49	1.1	1.1	0.49	0.49	1.1	1.1

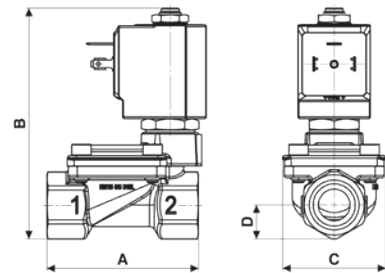

Flow direction overseat 1 → 2

Aggressive fluids

Valve code	Nominal Ø [mm]	Flow rate Kvs [l/min]	OPD			Coils	
			min. [barg]	max. AC [barg]	max. DC [barg]	code	[Volts/Hz]
D204DVZI	13	55	0.3	16	16	7250	24 VDC
D205DVZI	13	63	0.3	16	16	7200	24 V 50/60 Hz
D206DVYI	25	140	0.3	16	16	7400	110 V 50 Hz - 120 V 60 Hz
D222DVYI	25	160	0.3	16	16	7600	200 V 50 Hz - 220 V 60 Hz
						7700	230 V 50 Hz - 240 V 60 Hz

D204 – D222 - FKM seal, NC -

Coil power: AC 18 VA (holding)
 AC 36 VA (inrush)
 DC 14 W

Options

Manual override (e.g. code D205DBZIM)
 UL approved coil (e.g. code 770R)

Notes

Seamless tube as standard

Aggressive fluids

Valve code	Nominal Ø [mm]	Flow rate Kvs [l/min]	OPD			Coils class 'H' only	
			min. [barg]	max. AC [barg]	max. DC [barg]	code	[Volts/Hz]
RD204DVZI	13	55	0.3	16	16	7251	24 VDC
RD205DVZI	13	63	0.3	16	16	7201	24 V 50/60 Hz
RD206DVYI	25	140	0.3	16	16	7401	110 V 50 Hz - 120 V 60 Hz
RD222DVYI	25	160	0.3	16	16	7601	200 V 50 Hz - 220 V 60 Hz
						7701	230 V 50 Hz - 240 V 60 Hz

RD204 – RD222 - FKM seal, NO -

Coil power: AC 18 VA (holding)
 AC 36 VA (inrush)
 DC 14 W

Notes

Protective treatment of operators is recommended,
 minimum batch may be required (e.g. code RD204DVZIE)

2/2 way pilot operated solenoid valve, G 1/4" – G 1"

Common features

Media: water, oil, air
 Media temperature: -10 to +90 °C
 Ambient temperature: -10 to +50 °C
 Body material: brass (CW617N EN 12165)
 Operator material: stainless steel
 Operator seal and diaphragm material: NBR
 Protection class: IP 65 (with connector and gasket)

Options

FKM seal, temperature max. 130 °C (e.g. code B205DVZ)
 EPDM seal, temperature max. 120 °C (e.g. code B204DEZ)
 Electroless nickel plating treatment (e.g. code B205DBZK)
 NPT connection on request, minimum batch may be required (e.g. code RB205DBZN)
 UL approved coils (e.g. code 220R)
 Speed control screw only for type B206-, B222-, RB206- and RB222- (e.g. code B206DBYV / RB222DBYV)

TYPE: B203–B222

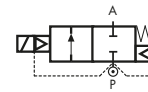

Normally Closed

TYPE: RB203–RB222

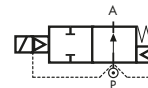

Normally Open



Dimensions & weights		B203 B204	B205	B206 compact	B206	B222	RB203 RB204	RB205	RB206 compact	RB206	RB222
G connection	[ISO 228]	1/4" 3/8"	1/2"	3/4"	3/4"	1"	1/4" 3/8"	1/2"	3/4"	3/4"	1"
A	[mm]	67	67	82	96	96	67	67	82	96	96
B	[mm]	90	90	105	115	115	92.5	92.5	107.5	117.5	117.5
C	[mm]	45.6	45.6	51.6	72	72	45.6	45.6	51.6	72	72
D	[mm]	15	15	20.25	23	23	15	15	20.25	23	23
weight	[kg]	0.4	0.4	0.6	1.2	1.2	0.4	0.4	0.6	1.2	1.2

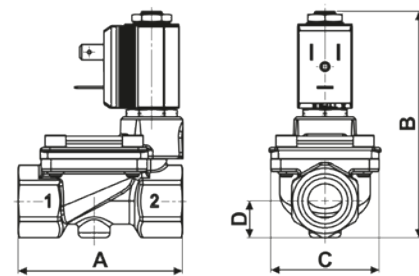

Flow direction overseat 1 → 2

General purpose

Valve	Nominal Ø	Flow rate Kvs	OPD			Coils	
			min.	max. AC	max. DC	code	[Volts/Hz]
code	[mm]	[l/min]	[barg]	[barg]	[barg]	code	[Volts/Hz]
B203DBZ	13	26	0.3	16	16	2250	24 VDC
B204DBZ	13	55	0.3	16	16	2200	24 V 50/60 Hz
B205DBZ	13	63	0.3	16	16	2400	110 V 50 Hz - 120 V 60 Hz
B206DBX comp.	21	100	0.3	16	16	2600	200 V 50 Hz - 220 V 60 Hz
B206DBY ¹	25	140	0.3	16	16	2700	230 V 50 Hz - 240 V 60 Hz
B222DBY	25	160	0.3	16	16		

B203 – B222 - NBR seal, NC -

Coil power: AC 10 VA (holding)
 AC 16 VA (inrush)
 DC 7 W

Options

Manual override (e.g. code B204DBZM)

General purpose

Valve	Nominal Ø	Flow rate Kvs	OPD			Coils	
			min.	max. AC	max. DC	code	[Volts/Hz]
code	[mm]	[l/min]	[barg]	[barg]	[barg]	code	[Volts/Hz]
RB203DBZ	13	26	0.3	16	16	2250 ²	24 VDC
RB204DBZ	13	55	0.3	16	16	2200	24 V 50/60 Hz
RB205DBZ	13	63	0.3	16	16	2400	110 V 50 Hz - 120 V 60 Hz
RB206DBX comp.	21	100	0.3	16	16	2600	200 V 50 Hz - 220 V 60 Hz
RB206DBY ¹	25	140	0.3	16	16	2700	230 V 50 Hz - 240 V 60 Hz
RB222DBY	25	160	0.3	16	16		

RB203 – RB222 - NBR seal, NO -

Coil power: AC 10 VA (holding)
 AC 16 VA (inrush)
 DC 7 W

¹ Product subject to phase-out, please contact Rotork Sales Department for availability

² For continuous service in DC we recommend the use of M&M coils 10 Watt, class H (see options on page 43)

2/2 way pilot operated solenoid valve, G 1/4" – G 1"

Common features

Media: water, air, oil
 Ambient temperature: -10 to +50 °C
 Media temperature: see table
 Maximum viscosity: Max. 21cST (3 °E)
 Body material: brass (CW617N EN 12165)
 Shading ring: copper
 Operator material: stainless steel
 Seal material: see table
 Protection class: IP 65 (EN 60529) with connector and gasket fitted*

Options

Electroless nickel plating treatment (e.g. code RSV01BG20A0WBK00)
 Silver shading ring (e.g. code RSV01BG20A0WBΔ00)
 NPT connection on request, minimum batch may be required (e.g. code RSV01BN20A0WB00)
 Stainless steel body (e.g. code RSV01BG20A0WBΔ00)

Notes

*Plug and gasket not supplied as standard, must be ordered separately (e.g. code RSV01BG20A0WB00 7700A)

TYPE: RSV01 NC

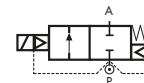

Normally Closed



Dimensions & weights		RSV01				
G connection	[ISO 228]	1/4"	3/8"	1/2"	3/4"	1"
A	[mm]	68.5	68.5	68.5	81.5	81.5
B	[mm]	96.5	96.5	96.5	110.5	10.5
C	[mm]	57	57	57	57	57
D	[mm]	13	13	13	20	20
weight	[kg]	0.5	0.5	0.5	0.8	0.7

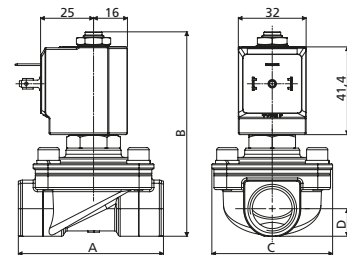

Flow direction overseat 1 → 2

Valve code	Seal material	Nominal Ø [mm]	Flow rate Kvs [l/min]	OPD			Coils	
				min. [barg]	max. AC [barg]	max. DC [barg]	code	[Volts/Hz]
RSV01BG20A0WB- RSV01BG20A0WV- RSV01BG20A0WE-	NBR FKM EPDM	16	1.5	0	16	-	0007	w/o coil
RSV01CG20A0WB- RSV01CG20A0WV- RSV01CG20A0WE-	NBR FKM EPDM		3.3				7700	230 V / 50 Hz 240 V / 60 Hz
RSV01DG20A0WB- RSV01DG20A0WV- RSV01DG20A0WE-	NBR FKM EPDM		4.2				7200	24 V 50 / 60 Hz
RSV01EG20A0XB- RSV01EG20A0XV- RSV01EG20A0XE-	NBR FKM EPDM	20	5.4	0	-	-	7400	110 V / 50 Hz 120 V / 60 Hz
RSV01FG20A0XB- RSV01FG20A0XV- RSV01FG20A0XE-	NBR FKM EPDM		7.4				7100	12 V / 50 / 60 Hz
RSV01BG20C0WB- RSV01BG20C0WV- RSV01BG20C0WE-	NBR FKM EPDM		1.5				12 ¹	7600
RSV01CG20C0WB- RSV01CG20C0WV- RSV01CG20C0WE-	NBR FKM EPDM	3.3	7300	48 V 50 / 60 Hz				
RSV01DG20C0WB- RSV01DG20C0WV- RSV01DG20C0WE-	NBR FKM EPDM	4.2	7250	24 VDC				
RSV01EG20C0XB- RSV01EG20C0XV- RSV01EG20C0XE-	NBR FKM EPDM	20	5.4	0	-	-	7150	12 VDC
RSV01FG20C0XB- RSV01FG20C0XV- RSV01FG20C0XE-	NBR FKM EPDM		7.4				Class H, High Power	
							72Z1	24 VDC

RSV01 - NBR seal, NC -

Media temperature: -10 to +90 °C
 Coil power: AC 18 VA (holding)
 AC 36 VA (inrush)
 DC 14 W
 DC 22 W (high power)

Options

FKM seal: media temperature max. 130 °C
 EPDM seal: media temperature max. 120 °C
 WRAS EPDM seal: media temperature -10 to +85 °C
 WRAS approval for brass valves only, special construction, (e.g. code RSV01DG20A0WY00W 77000)

¹ 0-14 bar with 72Z1 coil (22W)

Product coding example:

RSV01 C G 20 A 0 W B 0 K 0 7700 0 = 3/8" BSP G, 2/2, AC NC, brass body, 16 mm orifice, NBR seals, nickel plating, DIN coil, 230 V 50 Hz, without plug.

2/2 way pilot operated solenoid valve, G 1/4" – G 1"

Common features

Media: water, air, oil
 Ambient temperature: -10 to +50 °C
 Media temperature: see table
 Maximum viscosity: Max. 21cST (3 °E)
 Body material: brass (CW617N EN 12165)
 Shading ring: copper
 Operator material: stainless steel
 Seal material: see table
 Protection class: IP 65 (EN 60529) with connector and gasket fitted*

Options

Silver shading ring (e.g. code RSV01BG20R0WBA00)
 NPT connection on request, minimum batch may be required (e.g. code RSV01BN20R0WB00)
 Stainless steel body (e.g. code RSV01BG20R5WBA00)

Notes

*Plug and gasket not supplied as standard, must be ordered separately
 (e.g. code RSV01BG20R0WB00 7700A)

TYPE: RSV01 NO

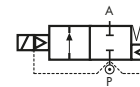

Normally Open



Dimensions & weights		RSV01				
G connection	[ISO 228]	1/4"	3/8"	1/2"	3/4"	1"
A	[mm]	68.5	68.5	68.5	81.5	81.5
B	[mm]	96.5	96.5	96.5	110.5	110.5
C	[mm]	57	57	57	57	57
D	[mm]	13	13	13	20	20
weight	[kg]	0.5	0.5	0.5	0.8	0.7

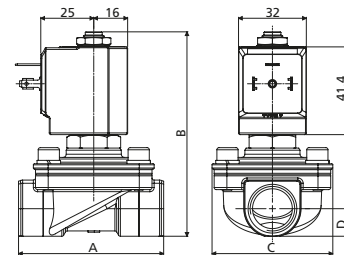

Flow direction overseat 1 → 2

Valve code	Seal material	Nominal Ø [mm]	Flow rate Kvs [l/min]	OPD		Coils	
				min. [barg]	max. [barg]	code	[Volts/Hz]
RSV01BG20R0WB- RSV01BG20R0WV- RSV01BG20R0WE-	NBR FKM EPDM	16	1.5	0	16	0007	w/o coil
						7700	230 V 50 Hz - 240 V 60 Hz
						7200	24 V 50 / 60 Hz
RSV01CG20R0WB- RSV01CG20R0WV- RSV01CG20R0WE-	NBR FKM EPDM	16	3.3	0	16	7400	110 V 50 Hz - 120 V 60 Hz
						7100	12 V / 50 / 60 Hz
						7600	200 V 50 Hz - 220 V 60 Hz
RSV01DG20R0WB- RSV01DG20R0WV- RSV01DG20R0WE-	NBR FKM EPDM	16	4.2	0	16	7300	48 V 50 / 60 Hz
						7250	24 VDC
						7150	12 VDC
Class H Coil options / Voltage / Power							
RSV01EG20R0XB- RSV01EG20R0XV- RSV01EG20R0XE-	NBR FKM EPDM	20	5.4	0	16	7701	230 V 50 Hz - 240 V 60 Hz
						7201	24 V 50 / 60 Hz
						7401	110 V 50 Hz - 120 V 60 Hz
RSV01FG20R0XB- RSV01FG20R0XV- RSV01FG20R0XE-	NBR FKM EPDM	20	7.4	0	16	7601	200 V 50 Hz - 220 V 60 Hz
						7251	24 VDC
						7151	12 VDC
						7451	110 VDC
						7101	12V 50 / 60 Hz
7301	48V 50 / 60 Hz						

RSV01 - NBR seal, NO -

Media temperature: -10 to +90 °C
 Coil power: AC 18 VA (holding)
 AC 36 VA (inrush)
 DC 14 W

Options

FKM seal: media temperature max. 130 °C
 EPDM seal: media temperature max. 120 °C
 WRAS EPDM seal: media temperature -10 to +85°C
 WRAS approval for brass valves only, special construction,
 (e.g. code RSV01DG20R0WY00W 77000)

Product coding example:

RSV01 C G 20 R 0 W B 0 A 0 7700 0 = 3/8" BSP G, 2/2, AC NC, brass body, 16 mm orifice, NBR seals, silver shading ring, DIN coil, 230 V 50 Hz, without plug.

2/2 way pilot operated solenoid valve, G 1 1/4" – G 2"

Common features

Media: water, oil, air
 Media temperature: -10 to +90 °C
 Ambient temperature: -10 to +50 °C
 Body material: brass (CW617N EN 12165)
 Operator material: stainless steel
 Operator seal and diaphragm material: NBR
 Silver shading ring as standard
 Protection class: IP 65 (with connector and gasket)
 Speed control screw as standard

Options

FKM seal, temperature max. 130 °C (e.g. code D223DVK)
 EPDM seal, temperature max. 120 °C (e.g. code RD223DEK)
 Electroless nickel plating treatment (e.g. code D222DVYK)
 NPT connection on request, minimum batch may be required (e.g. code D223DBKN)

TYPE: D223–D225

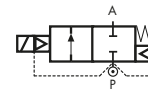

Normally Closed

TYPE: RD223–RD225

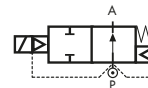

Normally Open



Dimensions & weights		D223	D224	D225	RD223	RD224	RD225
G connection	[ISO 228]	1 1/4"	1 1/2"	2"	1 1/4"	1 1/2"	2"
A	[mm]	140	140	168	140	140	168
B	[mm]	140	140	158	140	140	158
C	[mm]	96	96	112	96	96	112
D	[mm]	31	31	39	31	31	39
weight	[kg]	2.8	2.8	3.9	2.8	2.8	3.9

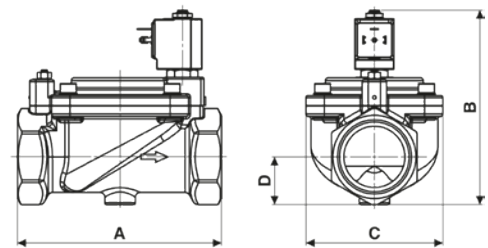

Flow direction overseat 1 → 2

General purpose

Valve	Nominal Ø	Flow rate Kvs	OPD			Coils	
			min.	max. AC	max. DC	code	[Volts/Hz]
code	[mm]	[l/min]	[barg]	[barg]	[barg]	code	[Volts/Hz]
D223DBK	40	370	0.5	16	16	7250	24 VDC
D224DBK	40	400	0.5	16	16	7200	24 V 50/60 Hz
D225DBJ	50	540	0.5	16	16	7400	110 V 50 Hz - 120 V 60 Hz
						7600	200 V 50 Hz - 220 V 60 Hz
						7700	230 V 50 Hz - 240 V 60 Hz

D223/224/225 - NBR seal, NC -

Coil power: AC 18 VA (holding)
 AC 36 VA (inrush)
 DC 14 W

Options

Manual override (e.g. code D223DBKM)
 For vacuum see page 39
 UL approved coils (e.g. code 725R)

General purpose

Valve	Nominal Ø	Flow rate Kvs	OPD			Coils class 'H' only	
			min.	max. AC	max. DC	code	[Volts/Hz]
code	[mm]	[l/min]	[barg]	[barg]	[barg]	code	[Volts/Hz]
RD223DBK	40	370	0.5	16	16	7251	24 VDC
RD224DBK	40	400	0.5	16	16	7201	24 V 50/60 Hz
RD225DBJ	50	540	0.5	16	16	7401	110 V 50 Hz - 120 V 60 Hz
						7601	200 V 50 Hz - 220 V 60 Hz
						7701	230 V 50 Hz - 240 V 60 Hz

D223/224/225 - NBR seal, NO -

Coil power: AC 18 VA (holding)
 AC 36 VA (inrush)
 DC 14 W

2/2 way pilot operated solenoid valve, G 1/4" – G 1/2"

Common features

Media: water, oil, air
 Ambient temperature: -10 to +50 °C
 Body material: brass (CW617N EN 12165)
 Operator material: stainless steel
 Protection class: IP 65 (with connector and gasket)

Options

EPDM seal, temperature max. 120 °C (e.g. code D266DEU)
 NPT connection on request, minimum batch may be required (e.g. code D264DBUN)

TYPE: D264/265/266

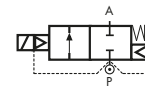

Normally Closed



Dimensions & weights		D264	D265	D266
G connection	[ISO 228]	1/4"	3/8"	1/2"
A	[mm]	54	54	54
B	[mm]	89	89	89
C	[mm]	Hex 27	Hex 27	Hex 27
D	[mm]	15	15	15
weight	[kg]	0.45	0.4	0.4

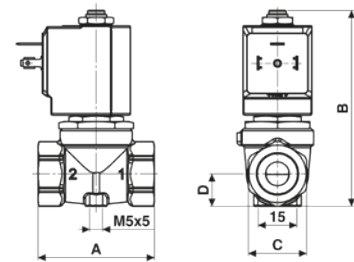

Flow direction overseat 1 → 2

Compressed air

Valve code	Nominal Ø [mm]	Flow rate Kvs [l/min]	OPD			Coils	
			min. [barg]	max. AC [barg]	max. DC [barg]	code	[Volts/Hz]
D264DBU	10.5	21	0.1	16	7	7250	24 VDC
D265DBU	10.5	24	0.1	16	7	7200	24 V 50/60 Hz
D266DBU	10.5	25	0.1	16	7	7400	110 V 50 Hz - 120 V 60 Hz
						7600	200 V 50 Hz - 220 V 60 Hz
						7700	230 V 50 Hz - 240 V 60 Hz

D264/265/266 - NBR seal, NC -

Media temperature: -10 to +90 °C
 Operator seal and diaphragm material: NBR
 Coil power: AC 18 VA (holding)
 AC 36 VA (inrush)
 DC 14 W

General purpose

Valve code	Nominal Ø [mm]	Flow rate Kvs [l/min]	OPD			Coils	
			min. [barg]	max. AC [barg]	max. DC [barg]	code	[Volts/Hz]
D264DVU	10.5	21	0.1	16	7	7250	24 VDC
D265DVU	10.5	24	0.1	16	7	7200	24 V 50/60 Hz
D266DVU	10.5	25	0.1	16	7	7400	110 V 50 Hz - 120 V 60 Hz
						7600	200 V 50 Hz - 220 V 60 Hz
						7700	230 V 50 Hz - 240 V 60 Hz

D264/265/266 - FKM seal, NC -

Media temperature: -10 to +130 °C
 Operator seal and diaphragm material: FKM
 Coil power: AC 18 VA (holding)
 AC 36 VA (inrush)
 DC 14 W

2/2 way pilot operated solenoid valve, G 1/4" – G 1/2"

Common features

Body material: brass (CW617N EN 12165)
 Orifice material: stainless steel (1.4305 EN 10088/AISI 303)
 Operator material: stainless steel
 Seal material: PTFE
 Protection class: IP 65 (with connector and gasket)

Notes

Seamless tube as standard

TYPE: D634–D636

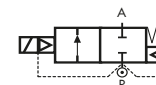

Normally Closed



Dimensions & weights		D634	D635	D636
G connection	[ISO 228]	1/4"	3/8"	1/2"
A	[mm]	54	54	54
B	[mm]	100	100	100
C	[mm]	Hex 27	Hex 27	Hex 27
D	[mm]	15	15	15
weight	[kg]	0.5	0.45	0.45

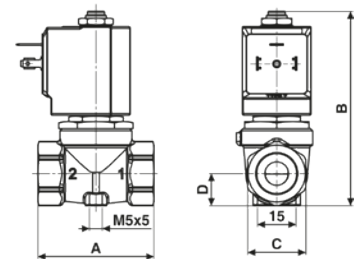

Flow direction overseat 1 → 2

High pressure

Valve code	Nominal Ø [mm]	Flow rate Kvs [l/min]	OPD			Coils high power - class 'H' only	
			min. [barg]	max. AC [barg]	max. DC [barg]	code	[Volts/Hz]
D634DTT1	10	21	0.3	140	35	72Z1	24 VDC
D635DTT1	10	24	0.3	140	35	72K1	24 V 50/60 Hz
D636DTT1	10	25	0.3	140	35	74K1	110 V 50 Hz - 120 V 60 Hz
						77K1	230 V 50 Hz - 240 V 60 Hz

D634–636DTT1 - PTFE seal, NC -

Media¹: water, oil, liquids
 Media temperature: -10 to +130 °C
 Ambient temperature: -10 to +50 °C
 Coil power: AC 25 VA (holding)
 AC 50 VA (inrush)
 DC 22 W

Notes

¹ Not 100% leak-proof when used with air/gases.
 Approximate leak rate is 1,5 ml/min at max. OPD

ATTENTION: When high pressure valves are supplied without a coil, their nameplates display the max. OPD of the valve when equipped with an AC (25 VA) and DC (22 W) coil (as shown in the table above). **When using alternative coil power ratings please ensure to request separately the appropriate nameplate at time of order.**

Steam

Valve code	Nominal Ø [mm]	Flow rate Kvs [l/min]	OPD			Coils class 'H' only	
			min. [barg]	max. AC [barg]	max. DC [barg]	code	[Volts/Hz]
D634DTT	10	21	0.3	9	9	72Z1	24 VDC
D635DTT	10	24	0.3	9	9	7201	24 V 50/60 Hz
D636DTT	10	25	0.3	9	9	7401	110 V 50 Hz - 120 V 60 Hz
						7601	200 V 50 Hz - 220 V 60 Hz
						7701	230 V 50 Hz - 240 V 60 Hz

D634–636DTT - PTFE seal, NC -

Media: steam
 Media temperature: +80 °C² to +180 °C
 Ambient temperature: -10 to +70 °C
 Coil power: AC 18 VA (holding)
 AC 36 VA (inrush)
 DC 22 W

Notes

² For a correct functioning, the minimum working temperature of the solenoid valve cannot be below 80 °C

2/2 way pilot operated solenoid valve, G 3/8" – G 3/4"

Common features

Media: water¹, oil, air²
 Media temperature: -10 to +130 °C
 Ambient temperature: -10 to +50 °C
 Body material: brass (CW617N EN 12165)
 Orifice material: stainless steel (1.4305 EN 10088/AISI 303)
 Operator material: stainless steel
 Protection class: IP 65 (with connector and gasket)

Notes

- ¹ When using liquid fluids waterhammer and pressures higher than 20 barg can cause the diaphragm to tear
- ² Not 100% leak-proof when used with air/gases.
 Approximate leak rate is 1,5 ml/min at max. OPD

Dimensions & weights		D232	D233	D234	RD232	RD233	RD234
G connection	[ISO 228]	3/8"	1/2"	3/4"	3/8"	1/2"	3/4"
A	[mm]	86	86	86	86	86	86
B	[mm]	116.5	116.5	116.5	114	114	114
C	[mm]	50.2	50.2	50.2	50.2	50.2	50.2
D	[mm]	17.5	17.5	17.5	17.5	17.5	17.5
weight	[kg]	1	0.9	0.9	1	0.9	0.9

High pressure

Valve code	Nominal Ø [mm]	Flow rate Kvs [l/min]	OPD			Coils	
			min. [barg]	max. AC [barg]	max. DC [barg]	code	[Volts/Hz]
D232DTW	16.5	42	1	50	50	7250	24 VDC
D233DTW	16.5	46	1	50	50	7200	24 V 50/60 Hz
D234DTW	16.5	48	1	50	50	7400	110 V 50 Hz - 120 V 60 Hz
						7600	200 V 50 Hz - 220 V 60 Hz
						7700	230 V 50 Hz - 240 V 60 Hz

High pressure

Valve code	Nominal Ø [mm]	Flow rate Kvs [l/min]	OPD			Coils class 'H' only	
			min. [barg]	max. AC [barg]	max. DC [barg]	code	[Volts/Hz]
RD232DTW	16.5	42	1	50	50	7251	24 VDC
RD233DTW	16.5	46	1	50	50	7201	24 V 50/60 Hz
RD234DTW	16.5	48	1	50	50	7401	110 V 50 Hz - 120 V 60 Hz
						7601	200 V 50 Hz - 220 V 60 Hz
						7701	230 V 50 Hz - 240 V 60 Hz

Compressed air

Valve code	Nominal Ø [mm]	Flow rate Kvs [l/min]	OPD			Coils	
			min. [barg]	max. AC [barg]	max. DC [barg]	code	[Volts/Hz]
D232DVW	16.5	42	1	25	25	7250	24 VDC
D233DVW	16.5	46	1	25	25	7200	24 V 50/60 Hz
D234DVW	16.5	48	1	25	25	7400	110 V 50 Hz - 120 V 60 Hz
						7600	200 V 50 Hz - 220 V 60 Hz
						7700	230 V 50 Hz - 240 V 60 Hz

TYPE: D232–D234

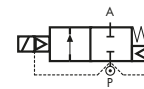

Normally Closed

TYPE: RD232–RD234

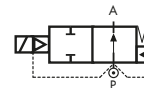

Normally Open

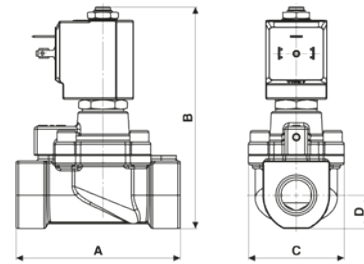

Flow direction overseat 1 → 2

D232/233/234 - PTFE seal, NC -

Operator seal material: Ruby
 Diaphragm material: FKM
 Main seal material: PTFE
 Coil power: AC 18 VA (holding)
 AC 36 VA (inrush)
 DC 14 W

Notes
 Seamless tube as standard

RD232/233/234 - PTFE seal, NO -

Operator seal material: Ruby
 Diaphragm material: FKM
 Main seal material: PTFE
 Coil power: AC 18 VA (holding)
 AC 36 VA (inrush)
 DC 14 W

Options
 FKM seal version (e.g. code RD232DVW).
 Temperature max. 130 °C - OPD max.: 25 barg AC/DC.
 Minimum batch may be required

D232/233/234 - FKM seal, NC -

Operator seal material: foodgrade FKM
 Diaphragm material: FKM
 Main seal material: FKM
 Coil power: AC 18 VA (holding)
 AC 36 VA (inrush)
 DC 14 W

2/2 way pilot operated solenoid valve, G 3/4" – G 1"

Common features

Media¹: steam
 Media temperature: +80 °C² to +180 °C
 Ambient temperature: -10 to +70 °C
 Body material: brass (CW617N EN 12165)
 Operator material: stainless steel
 Orifice material: stainless steel (1.4305 EN 10088/AISI 303)
 Operator seal material: PTFE
 Main seal and diaphragm material: PTFE
 Protection class: IP 65 (with connector and gasket)

Options

NPT connection on request, minimum batch may be required (e.g. code D622DTY_N)

Notes

- ¹ Water & high content of condensate can damage the diaphragm.
² For a correct functioning, the minimum working temperature of the solenoid valve cannot be below 80 °C.

Dimensions & weights		D606 RD606	D622 RD622
G connection	[ISO 228]	3/4"	1"
A	[mm]	96	96
B	[mm]	126	126
C	[mm]	72	72
D	[mm]	24	24
weight	[kg]	1.3	1.3

Steam

Valve code	Nominal Ø [mm]	Flow rate Kvs [l/min]	OPD			Coils class 'H' only	
			min. [barg]	max. AC [barg]	max. DC [barg]	code	[Volts/Hz]
D606DTY	24	120	1	9	9	7151	12 VDC
D622DTY	24	120	1	9	9	7251	24 VDC
						7201	24 V 50/60 Hz
						7401	110 V 50 Hz - 120 V 60 Hz
						7601	200 V 50 Hz - 220 V 60 Hz
						7701	230 V 50 Hz - 240 V 60 Hz

Steam

Valve code	Nominal Ø [mm]	Flow rate Kvs [l/min]	OPD			Coils class 'H' only	
			min. [barg]	max. AC [barg]	max. DC [barg]	code	[Volts/Hz]
RD606DTY	24	120	1	9	9	7151	12 VDC
RD622DTY	24	120	1	9	9	7251	24 VDC
						7201	24 V 50/60 Hz
						7401	110 V 50 Hz - 120 V 60 Hz
						7601	200 V 50 Hz - 220 V 60 Hz
						7701	230 V 50 Hz - 240 V 60 Hz

TYPE: D606/622

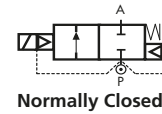

TYPE: RD606/622

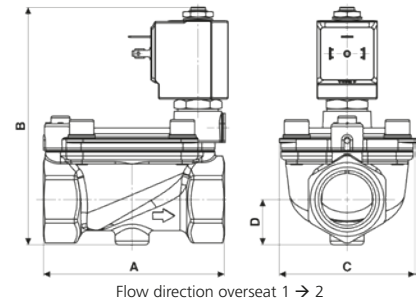
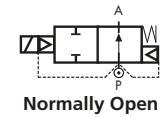

D606/D622 - PTFE seal, NC -

Coil power: AC 18 VA (holding)
 AC 36 VA (inrush)
 DC 14 W

Notes
 Seamless tube as standard

RD606/RD622 - PTFE seal, NO -

Coil power: AC 18 VA (holding)
 AC 36 VA (inrush)
 DC 14 W

2/2 way latching solenoid valve (pilot operated), G 1/4" – G 1/2"

Common features

Media: water, oil, air
 Ambient temperature: -10 to +50 °C
 Body material: brass (CW617N EN 12165)
 Operator material: stainless steel tube, brass plunger
 Protection class: IP 65 (with connector and gasket)

Notes

Special operator with reduced stroke for low power coils

TYPE: LC203–LC205

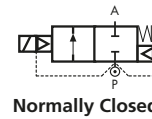

Dimensions & weights		LC203	LC204	LC205
G connection	[ISO 228]	1/4"	3/8"	1/2"
A	[mm]	67	67	67
B	[mm]	90	90	90
C	[mm]	45.6	45.6	45.6
D	[mm]	15	15	15
weight	[kg]	0.4	0.4	0.4

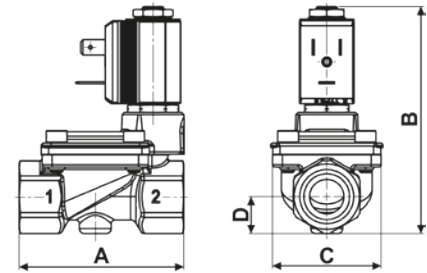

Flow direction overseat 1 → 2

General purpose

Valve code	Nominal Ø [mm]	Flow rate Kvs [l/min]	OPD			Coils low power only	
			min. [barg]	max. AC [barg]	max. DC [barg]	code	[Volts/Hz]
LC203DBZ	13	26	0.3	—	5	20Q0	6 VDC
LC204DBZ	13	55	0.3	—	5	21Q0	12 VDC
LC205DBZ	13	63	0.3	—	5	22Q0	24 VDC

LC203 – LC205 - NBR seal -

Media temperature: -10 to +90 °C
 Operator seal and diaphragm material: NBR
 Coil power: DC 3 W
 Absorption (20 °C): 500mA for **20Q0**
 250mA for **21Q0**
 125mA for **22Q0**

General purpose

Valve code	Nominal Ø [mm]	Flow rate Kvs [l/min]	OPD			Coils low power only	
			min. [barg]	max. AC [barg]	max. DC [barg]	code	[Volts/Hz]
LC203DYZ	13	26	0.3	—	5	20Q0	6 VDC
LC204DYZ	13	55	0.3	—	5	21Q0	12 VDC
LC205DYZ	13	63	0.3	—	5	22Q0	24 VDC

LC203 – LC205 - FKM seal -

Media temperature: -10 to +130 °C
 Operator seal and diaphragm material: FKM
 Coil power: DC 3 W
 Absorption (20 °C): 500mA for **20Q0**
 250mA for **21Q0**
 125mA for **22Q0**

General purpose

Valve code	Nominal Ø [mm]	Flow rate Kvs [l/min]	OPD			Coils low power only	
			min. [barg]	max. AC [barg]	max. DC [barg]	code	[Volts/Hz]
LC203DEZ	13	26	0.3	—	5	20Q0	6 VDC
LC204DEZ	13	55	0.3	—	5	21Q0	12 VDC
LC205DEZ	13	63	0.3	—	5	22Q0	24 VDC

LC203 – LC205 - EPDM seal -

Media temperature: -10 to +120 °C
 Operator seal and diaphragm material: EPDM
 Coil power: DC 3 W
 Absorption (20 °C): 500mA for **20Q0**
 250mA for **21Q0**
 125mA for **22Q0**

Solenoid valves for vacuum

The following solenoid valves are also available with a configuration suitable for vacuum (the general technical features are listed on the individual single pages of solenoid valves):

- D262/D263** – see page 14
- D237/238/239** – see page 17
- C D237/238/239** – see page 17
- D362/D363** – see page 25
- D223–225** – see page 33
- D203–D222** – individual datasheet on request



CONNECTION SCHEME ACCORDING TO VALVE TYPES:

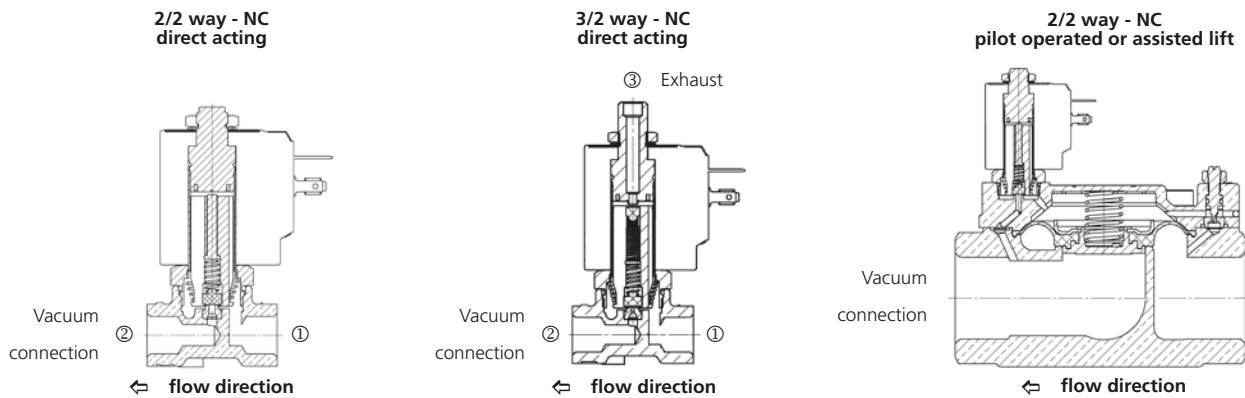

Valve	Nominal Ø	Flow rate Kvs	OPD			Coils	
			min.	max. AC	max. DC	Code	[Volts/Hz]
Code	[mm]	[l/min]	[barg]	[barg]	[barg]		
D203DBZL	13	26	-0.2	-0.95	-0.95	7400	110 V 50 Hz - 120 V 60 Hz
D205DBZL	13	63	-0.2	-0.95	-0.95	7600	200 V 50 Hz - 220 V 60 Hz
D205DEZL	13	63	-0.2	-0.95	-0.95	7700	230 V 50 Hz - 240 V 60 Hz
D225DBJL	50	540	-0.5	-0.95	-0.95		
D263DBPL	6	8	-0.9	1	1		
D362CVGL	2.5	3.4	0	-0.95	-0.95		
D363CVGL	2.5	3.4	0	-0.95	-0.95		
D363CVHL	3	4.5	0	-0.95	-0.95		

Various part numbers

Coil power: AC 18 VA (holding)
AC 36 VA (inrush)
DC 14 W

Options

Class 'H' insulation coils (e.g. code 7701)

Valve	Nominal Ø	Flow rate Kvs	OPD			Coils	
			min.	max. AC	max. DC	Code	[Volts/Hz]
Code	[mm]	[l/min]	[barg]	[barg]	[barg]		
D237DBU1	10.5	21	0	-0.95	—	72K1	24 V 50/60 Hz
D238DBU1	10.5	24	0	-0.95	—	74K1	110 V 50 Hz - 120 V 60 Hz
D239DBU1	10.5	25	0	-0.95	—	77K1	230 V 50 Hz - 240 V 60 Hz

D237 – 239DBU1 - NBR seal, AC -

Seal material: NBR 60 shore
Coil power: AC 25 VA (holding)
AC 50 VA (inrush)

Notes

Minimum batch may be required

Valve	Nominal Ø	Flow rate Kvs	OPD			Coils	
			min.	max. AC	max. DC	Code	[Volts/Hz]
Code	[mm]	[l/min]	[barg]	[barg]	[barg]		
C D237DBU1	10.5	21	0	—	-0.95	72Z1	24 VDC
C D238DBU1	10.5	24	0	—	-0.95		
C D239DBU1	10.5	25	0	—	-0.95		

C D237 – 239DBU1 - NBR seal, DC -

Seal material: NBR 60 shore
Coil power: DC 22 W

Notes

Minimum batch may be required

2/2 way direct acting "dry armature" solenoid valve, G 3/8"

Common features

Media: water and beverages
 Media temperature: -10 to +95 °C
 Ambient temperature: -10 to +50 °C
 Body material: brass (CW617N EN 12165)
 Operator material: stainless steel
 Seal material: silicone FDA compliant
 Protection class: IP 65 (with connector and gasket)

Notes

TOTAL SEPARATION BETWEEN INTERNAL PARTS AND MEDIUM

TYPE: 211

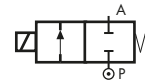

Normally Closed



Dimensions & weights		D211	C D211
G connection	[ISO 228]	3/8"	3/8"
A	[mm]	43.4	43.4
B	[mm]	88.8	88.8
C	[mm]	36	36
D	[mm]	22	22
weight	[kg]	0.34	0.34

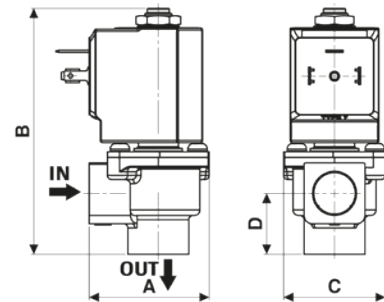

Flow rate chart

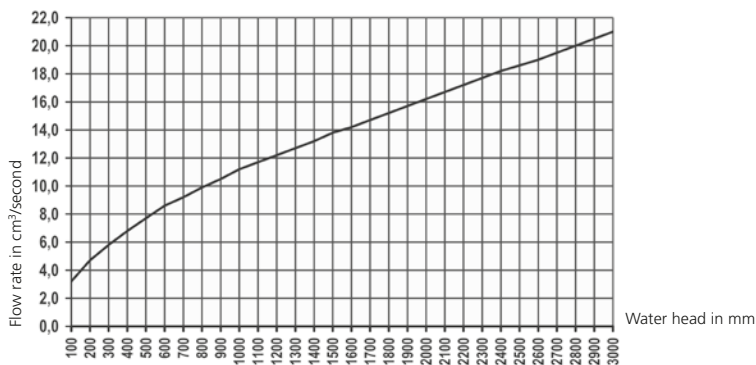

Valve code	Nominal Ø [mm]	Flow rate Kvs [l/min]	OPD			Coils	
			min. [barg]	max. AC [barg]	max. DC [barg]	code	[Volts/Hz]
D211DSU	11	see flow chart	0	0.3	—	7250	24 VDC
C D211DSU	11	see flow chart	0	—	0.2	7200	24 V 50/60 Hz
						7400	110 V 50 Hz - 120 V 60 Hz
						7600	200 V 50 Hz - 220 V 60 Hz
						7700	230 V 50 Hz - 240 V 60 Hz

D211 - Silicone FDA seal, NC -

Coil power: AC 18 VA (holding)
 AC 36 VA (inrush)
 DC 14 W

Options

Electroless nickel plating treatment (e.g. code D211DSU \bar{K})

Automatic drain valve systems with solenoid valves

Preassembled systems consisting of solenoid valve, timer and connector for time adjusted condensate discharge of tanks with compressed air, separators, mains drainage, dryers and filters.

Common features

Media: water, oil, air and inert gases
 Media temperature: -10 to +130 °C
 Ambient temperature: -10 to +50 °C
 Seal material: FKM
 Coil power: AC 18 VA (holding)
 AC 36 VA (inrush)
 DC 14 W

Protection class: IP 65 (with connector and gasket)
 Discharge time: 0.5 to 10 seconds
 Interval time: 30 seconds to 45 minutes
 Test switch: manual

Options

UL approved coils
 Valve with NPT connection upon request, minimum batch may be required (e.g. code D249DVF^N)
 Available with analogue timer (see page 41)

Notes

For more detailed information about the various components (solenoid valve/timer/connector), please refer to individual datasheet



USERS BENEFITS:

- Adjustable to suit your system requirements
- Indoor / outdoor installations
- Reliable, long life
- Cost effective
- Visual indication of operation
- Manual override – test button

Dimensions & weights		AT2720
A	[mm]	43
B	[mm]	74
C	[mm]	20
weight	[kg]	0.077

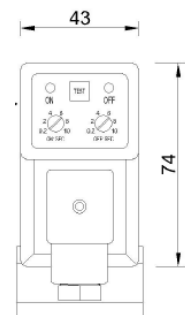

Compressed air

ADV	Timer	Connector	Valve	G connection	nominal Ø	flow rate Kvs	OPD			Voltage
							min.	max. AC	max. DC	
with direct acting solenoid valves										serie 7000 coils
code	code	code	code	[ISO 228]	[mm]	[l/min]	[barg]	[barg]	[barg]	[Volts/Hz]
888 120 00-	AT2720	600011-	D249DVF	1/4"	2.2	2.4	0	18	—	110 V 50 Hz - 120 V 60 Hz
888 121 00-							0	18	—	230 V 50 Hz - 240 V 60 Hz
888 122 00-							0	—	16	24 VDC
with pilot operated solenoid valves										serie 7000 coils
888 123 00-	AT2720	600011-	D264DVU	1/4"	10.5	21	0.1	16	—	110 V 50 Hz - 120 V 60 Hz
888 124 00-							0.1	16	—	230 V 50 Hz - 240 V 60 Hz
888 125 00-							0.1	—	7	24 VDC
888 126 00-			D265DVU	3/8"	10.5	24	0.1	16	—	110 V 50 Hz - 120 V 60 Hz
888 127 00-							0.1	16	—	230 V 50 Hz - 240 V 60 Hz
888 128 00-							0.1	—	7	24 VDC
888 129 00-			D266DVU	1/2"	10.5	25	0.1	16	—	110 V 50 Hz - 120 V 60 Hz
888 130 00-							0.1	16	—	230 V 50 Hz - 240 V 60 Hz
888 131 00-							0.1	—	7	24 VDC

Analogue electronic timer

Ideal for: Automatic Drain Valves - Sampling Valves - Lubrication System - Air Dryers.

TYPE: AT2720

Features

Supply voltage: UL 24 – 240 VAC/VDC - 50/60 Hz (Code **AT2720C021**)
 CE 24 – 240 VAC/VDC - 50/60 Hz

Absorption: 4 mA max.

Operation temperature: -10 to +60 °C

Protection class: IP 65 (according to EN60529) with connector and gasket

Switch holding voltage: 400 V max.

Switch capacity: 1A

Inrush current: 10A for 10 ms

Duty cycle: 100% ED

Switch life: $3 \cdot 10^8$

Repeat accuracy: $\pm 1\%$

Timing temperature coefficient: $\pm 0.005\% - ^\circ\text{C}$

Time ON: ■ from 0.5 to 10 seconds

Time OFF: ■ from 30 seconds to 45 minutes

Set/Reset/Test: membrane key

Circuit: UL 94 V0

Indicators: YELLOW LED for 'power ON'
 YELLOW LED for 'valve open'

Manual override: Test

Colour: Black

Notes

In case of DC supply, polarity should be reversed: left fast-on positive (+), right fast-on negative (-). Please refer to product instructions for use
 Timers are supplied in single boxes with one squared gasket and M3x50 fixing screw
 (see assembling scheme)



Dimensions & weights		AT2720
A	[mm]	43
B	[mm]	74
C	[mm]	20
weight	[kg]	0.077

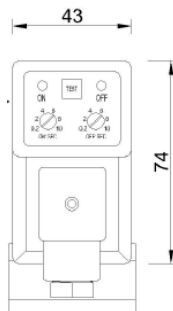

Assembling scheme

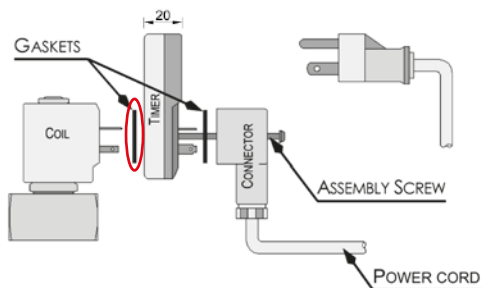

Coils for M&M branded solenoid valves

M&M International coils are designed for continuous duty in conformity to the EN 60730 safety standards. They are encapsulated in a self-extinguishing synthetic material and offer high mechanical protection and excellent thermal dissipation. They are fully interchangeable on all M&M International solenoid valves, thereby reducing warehouse inventories.

Common features

Electrical connection: fast on connection 6,3x0,8
 Protection class: IP 65 (according to EN60529) - NEMA 4 (UL 50) with connector and gasket
 Operation: continuous (ED 100%)
 Voltage tolerance: AC +10% to -15%
 DC +10% to -5%

Notes

All coils manufactured under M&M brand comply with the RoHS Directive (2011/65/EU)
 Insulation class according to EN 60730-1 see the below table
 All windings are realised with class 'H' wires (180 °C)
 Custom voltages and low power consumption available: please contact Rotork Sales Department
Minimum batch quantity required for some voltage ratings



SERIES: 2000



SERIES: 7000

Dimensions & weights		Series 2000	Series 7000
A	(mm)	19.5	25
B	(mm)	11.2	16
C	(mm)	22.3	32
D	(mm)	33.7	41.4
Weight	(kg)	0.060	0.146

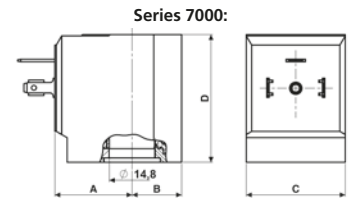
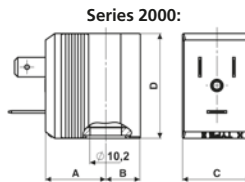

Coils	Voltage	Power		Class	Ambient Temperature		Media Temperature ¹	
		Holding	Inrush		Min.	Max.	Min.	Max.
2150	12 VDC	7 W	—	F 155 °C	-10 °C	+50 °C	-10 °C	+130 °C
2250	24 VDC	7 W	—					
2750	230 VDC	7 W	—					
2100	12 V / 50/60 Hz	10 VA	16 VA					
2200	24 V / 50/60 Hz	10 VA	16 VA					
2300	48 V / 50/60 Hz	10 VA	16 VA					
2400	110 V / 50 Hz - 120 V / 60 Hz	10 VA	16 VA					
2600	200 V / 50 Hz - 220 V / 60 Hz	10 VA	16 VA					
2700	230 V / 50 Hz - 240 V / 60 Hz	10 VA	16 VA	F 155 °C	-10 °C	+60 °C	-10 °C	+130 °C
215R	12 VDC	6 W	—					
225R	24 VDC	6 W	—					
220R	24 V / 50 Hz	9 VA	14 VA					
226R	24 V / 60 Hz	9 VA	14 VA					
240R	110 V / 50 Hz - 120 V / 60 Hz	9 VA	14 VA					
270R	230 V / 50 Hz - 240 V / 60 Hz	9 VA	14 VA					
B150	12 VDC	7 W	—					
B250	24 VDC	7 W	—					
B200	24 V / 50/60 Hz	10 VA	16 VA					
B400	110 V / 50 Hz - 120 V / 60 Hz	10 VA	16 VA					
B700	230 V / 50 Hz - 240 V / 60 Hz	10 VA	16 VA					
21V1	12 VDC	10 W	—	H 180 °C	-10 °C	+70 °C	-10 °C	+130 °C
22V1	24 VDC	10 W	—					

Series 2000 - Standard

Connection: to DIN 46244

Series 200R - UL approved

UL approved coils recognized component, file number E193928

Series B000 - Impregnated

Impregnated coils for humid environments (e.g. code B400)

Series 2001 - Class 'H'

¹ Some valve configurations allow a max. fluid temperature up to 180 °C, please check valve datasheets.

Coils for M&M branded solenoid valves

Coils	Voltage	Power		Class	Ambient Temperature		Media Temperature ¹	
		Holding	Inrush		Min.	Max.	Min.	Max.
7150	12 VDC	14 W	—	F 155 °C	-10 °C	+50 °C	-10 °C	+130 °C
7250	24 VDC	14 W	—					
7750	230 VDC	14 W	—					
7100	12 V / 50/60 Hz	18 VA	36 VA					
7200	24 V / 50/60 Hz	18 VA	36 VA					
7300	48 V / 50/60 Hz	18 VA	36 VA					
7400	110 V / 50 Hz - 120 V / 60 Hz	18 VA	36 VA					
7600	200 V / 50 Hz - 220 V / 60 Hz	18 VA	36 VA					
7700	230 V / 50 Hz - 240 V / 60 Hz	18 VA	36 VA					
725R	24 VDC	10 W	—					
720R	24 V / 50 Hz	15 VA	30 VA					
740R	110 V / 50 Hz - 120 V / 60 Hz	15 VA	30 VA					
770R	230 V / 50 Hz - 240 V / 60 Hz	15 VA	30 VA					
7251	24 VDC	14 W	—	H 180 °C	-10 °C	+70 °C	-10 °C	+130 °C
7201	24 V / 50/60 Hz	18 VA	36 VA					
7401	110 V / 50 Hz - 120 V / 60 Hz	18 VA	36 VA					
7701	230 V / 50 Hz - 24 V / 60 Hz	18 VA	36 VA					
7121	12 VDC	22 W	—	H 180 °C	-10 °C	+70 °C	-10 °C	+130 °C
7221	24 VDC	22 W	—					
72K1	24 V / 50/60 Hz	25 VA	50 VA					
74K1	110 V / 50 Hz - 120 V / 60 Hz	25 VA	50 VA					
77K1	230 V / 50 Hz - 240 V / 60 Hz	25 VA	50 VA					

Series 7000 - Standard
Connection: to DIN EN 175301-803 form A (ex DIN 43650-A)

OPTIONS
Impregnated coils for humid environments (e.g. code D400)

Series 700R - UL approved
UL approved coils recognized component, file number E193928

Series 7001 - Class 'H'

OPTIONS
Impregnated coils for humid environments (e.g. code D701)

Series 7000 - High Power

OPTIONS
Impregnated coils for humid environments (e.g. code D7K1)

¹ Some valve configurations allow a max. fluid temperature up to 180 °C, please check valve datasheets.

DIN connectors for M&M branded solenoid valves

Coil connectors provide the safest flexible system for connecting M&M International solenoid valves and give a protection class of IP65. They are designed and made of synthetic material offering a high level of electrical insulation. Compliance with UL 1977 and VDE Regulations.

Common Features

Rated voltage (max.): 250 VAC / 300 VDC
 Nominal current: 10 A (Rated) / 16A (max.)
 Wire cross-section: 1.5 mm² (max.)
 Cable entry: PG9 (6 to 8 mm)
 Protection class: IP 65 (only with gasket)
 Insulation class: group C - VDE 0110
 Housing colour: black

Options

Connectors with protection circuits
 Connectors with LED
 Connectors with flying leads
 Other versions available upon request and depending on quantity:
 please contact Rotork Sales Department

Notes

Connectors are supplied with thermoplastic rubber bordered gasket, fixing screw and preinstalled position with ground H 12 (the connector can be spinned when connected)



TYPE: 600 001-



TYPE: 600 011-



Dimensions & weights		600001-	600011-
A	(mm)	28.5	27.7
B	(mm)	14.5	18
C	(mm)	11	18
D	(mm)	21.5	27.7
E	(mm)	41.2	41
F	(mm)	28.8	26.8
G	(mm)	5.5	5.5
weight	(kg)	0.019	0.020

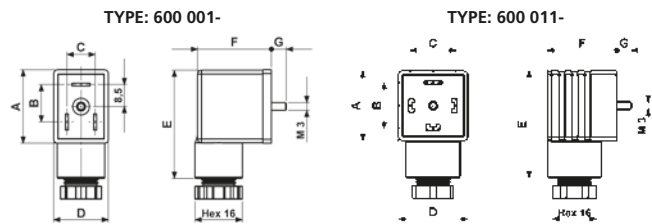

Customised products

Rotork is constantly evolving and developing new products, enabling us to remain competitive in an ever changing market and keeping at the forefront of technological advances. For many years our team has operated in the most diverse industrial sectors and therefore acquired vast experience with a multitude of specialist applications. Our experience enables us to understand, design and manufacture to our customers' specific requirements.

We can develop new customised solenoid valve solutions according to the customers' technical requirements and needs, concentrating on increasing functionality, optimising space and reducing costs of existing systems.

Please find below some examples:

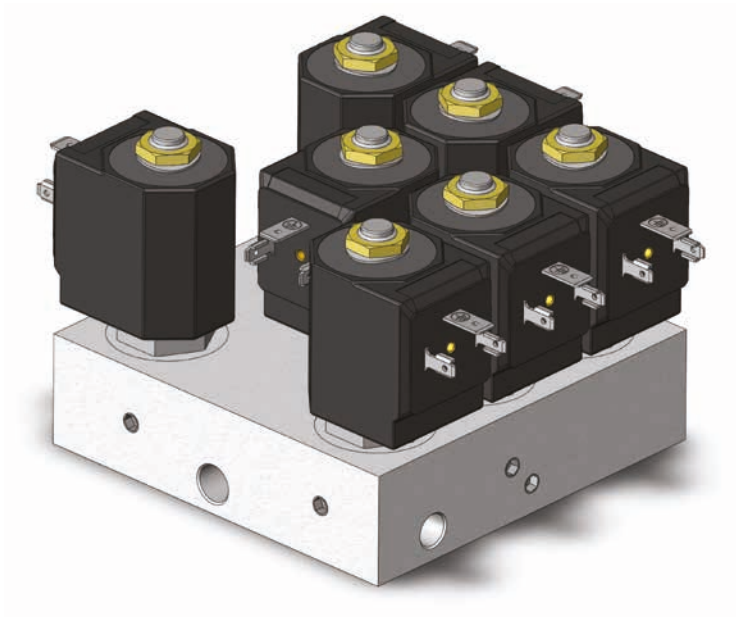

CAR AIR CONDITIONING REFILLER

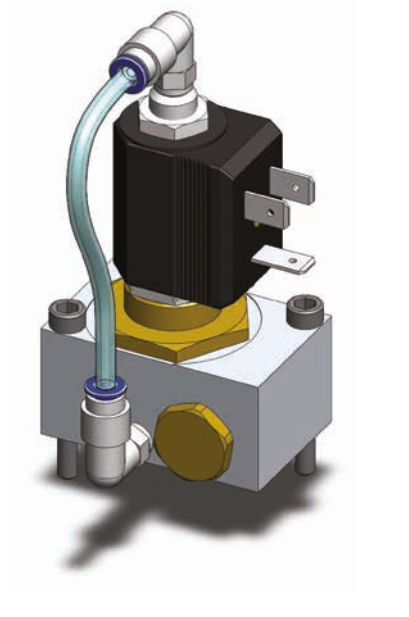

COMPRESSED AIR TREATMENT

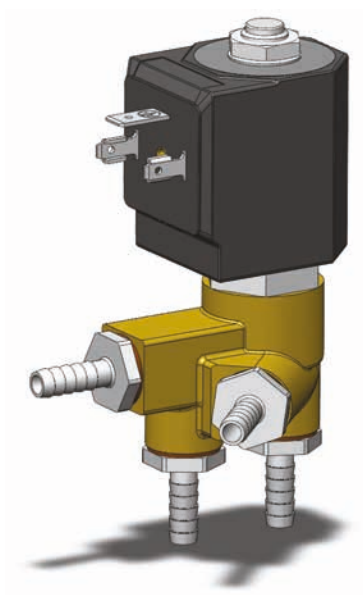

STERILISERS

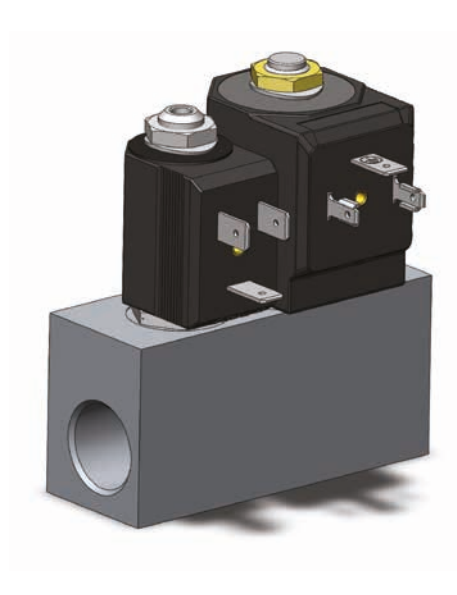

PACKAGING WITH VACUUM SYSTEMS FOR INDUSTRY

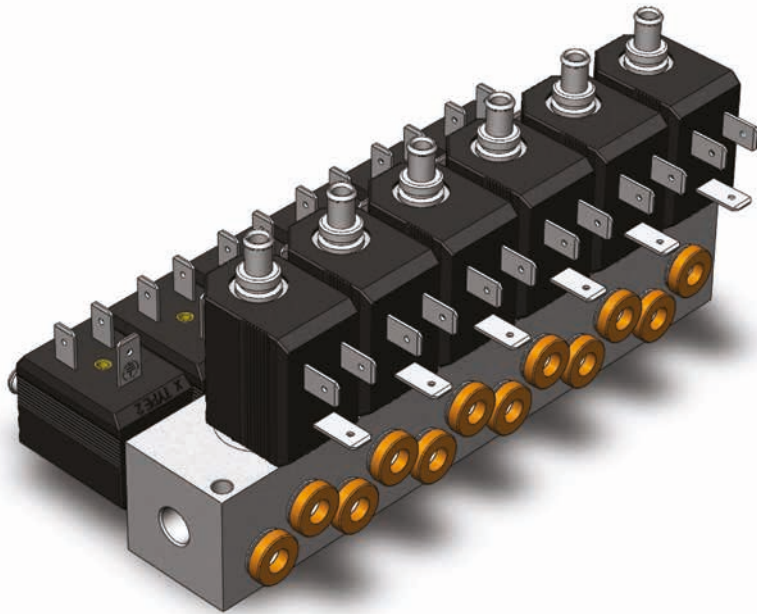

INDUSTRIAL AUTOMATION

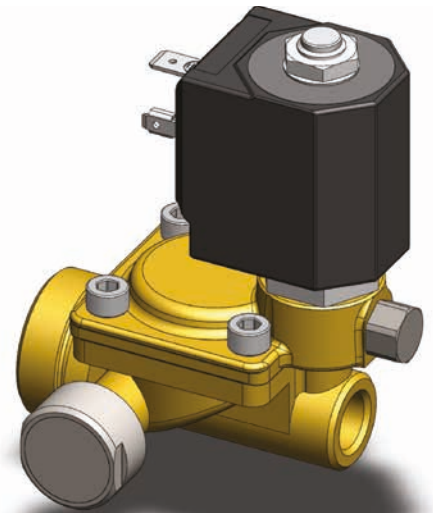

FIREFIGHTING SYSTEMS

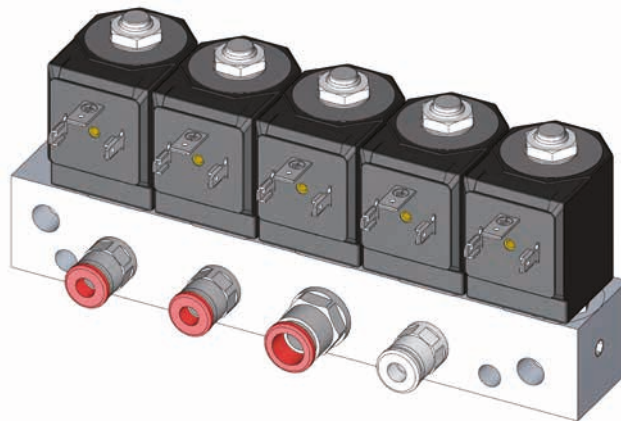

COOLING SYSTEM

Valve selection

Valve Selection

A solenoid valve should be chosen whenever the following conditions are met:

- ✓ Media without dirt particles
- ✓ Moderate flow volumes
- ✓ Average differential pressures
- ✓ High speed in operation
- ✓ Media with a viscosity not higher than 21 cST(3°E)

Valve Types

Direct acting solenoid valves 2/2 and 3/2 way NC or NO

When energised the coil electrically generates a magnetic force attracting the armature towards the fixed core. Inside the armature is a seal that acts upon the main orifice, either when the coil is de-energised (normally closed) or when the coil is energised (normally open). By revealing the orifice allows the fluid to pass. Average response time 5 – 25 ms.

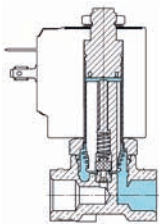

Pilot operated solenoid valves 2/2 way NC or NO

This solenoid valve uses the force of the fluid to operate the valve via a suitable integral pilot valve. The inlet pressure must always be at least the same as the minimum ΔP figure shown on the datasheets. Using the same coils as direct acting valves much higher fluid volumes and pressures can be controlled with this solenoid valve. Average response time 50 – 500 ms.

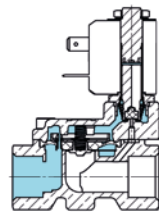

Pilot operated solenoid valves with assisted lift 2/2 way NC

These solenoid valves are a combination of the pilot operated valves and the direct acting valves. The armature is mechanically connected to the diaphragm on which there is a pilot orifice. With minimal pressures the solenoid valve acts like a direct acting valve. Total opening as well as full flow do not occur at low pressures. With higher pressures it works as a pilot operated valve with full opening. Average response time 50 – 500 ms.

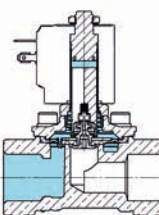

Function Types

2/2 way function indicates valves with inlet and outlet connections, whilst valves with 3/2 way functions have 3 connections and 2 flow passages. One orifice always remains open and one closed. Connections and flow direction are shown in the symbols on each technical datasheet (DIN-ISO 1219).

At rest valves can be either normally closed (NC) or normally open (NO):

- Normally closed (NC): the valve opens when the coil is energised.
- Normally open (NO): the valve closes when the coil is energised.

Optional Features

Manual Override (M)

Normally closed direct acting and pilot operated solenoid valves can be supplied with a manual override which allows the valve to be opened independently of electrical current.

Waterhammer Control (V)

Pilot operated solenoid valves (only versions specified in each datasheet) can be supplied with a system that regulates the closing speed of the diaphragm in order to control waterhammer.

The seal closing speed is operated by the adjusting screw: by screwing it clockwise (in the "+" direction) when using liquid, the valve will close slower reducing any waterhammer effect that may occur in the solenoid valve and the upstream pipes.

In the case of larger valves (1¹/₄", 1¹/₂" and 2"), please adjust the anti-waterhammer screw to ensure that that valve closes as slowly as possible in order to avoid causing any damage that may affect the functioning of the equipment and valve due to the waterhammer effect.

Technical information

The following points should be considered to ensure a correct choice of valve:

Connections and Nominal Diameters

Threaded connections are either "G"- inches (ISO 228) or metric. Nominal diameters (DN) are expressed in millimetres and correspond to the diameter of the valve's main orifice.

Performances (OPD)

Pressure values shown in this catalogue are the max values expressed in relative bar with no pressure at outlet.

For 3/2 way solenoid valves the pressure range can vary when used in other functions or systems.

The maximum pressure (PN) that the valve can tolerate is tested to 1.5 times the maximum value of the operating pressure differential (OPD).

Pressure (units of measurement)

The SI unit of pressure is the pascal (Pa), defined as 1 newton of force per square metre (1 N/m²).

As Pa is such a small unit, the kPa (1 kilonewton/m²) or MPa (1 Meganewton/m²) tend to be more appropriate to fluid engineering.

However, the most popular metric unit used to measure the pressure in fluid engineering field is the bar, which is equal to 105 N/m², and approximates to 1 atmosphere. This unit is used throughout this publication.

Other units often used include lb/in² (PSI), kg/cm², atm in H₂O (atmosphere) and mm Hg. Conversion factors are readily available from many sources.

Absolute pressure (bar a)

This is the pressure measured from the datum of a perfect vacuum: i.e. a perfect vacuum has a pressure of 0 bar a.

Gauge pressure (bar g)

This is the pressure measured from the datum of the atmospheric pressure. Although in reality the atmospheric pressure will depend upon the climate and the height above sea level, a generally accepted value of 1.013 bar a (1 atm) is often used. This is the average pressure exerted by the air of the earth's atmosphere at sea level.

Gauge pressure = Absolute pressure - Atmospheric pressure

Pressure above atmospheric will always yield a positive gauge pressure. Conversely a vacuum or negative pressure is the pressure below that of the atmosphere. A pressure of -1 bar g corresponds closely to a perfect vacuum.

Differential pressure

This is simply the difference between two pressures. When specifying a differential pressure, it is not necessary to use the suffixes 'g' or 'a' to denote either gauge pressure or absolute pressure respectively, as the pressure datum point becomes irrelevant. Therefore the difference between two pressures will have the same value whether these pressures are measured in gauge pressure or absolute pressure, as long as the two pressures are measured from the same datum.

Flow

The flow is the quantity of fluid that passes through the valve's main orifice which has the nominal diameter (DN) shown in the tables.

The flow is given with a constant Kv value (according to VDI/VDE 2173) that shows how many cubic meters of water, at a temperature of 20 °C, flow through the valve in one hour with a pressure difference of one bar across the valve.

To determine the flow at higher pressures, multiply the Kv value by the square root of the differential pressure. Flow values shown in the selection tables are subject to a tolerance of ± 15%.

Viscosity

Viscosity of a fluid (liquid or gas) is its resistance to flow freely in a duct.

This phenomenon is also called internal friction and depends on existing cohesion forces among the fluid molecules. The viscosity of liquids decreases as the temperature rises; the viscosity of gases grows if the volume does not change.

According to the International System of Units (SI), the physical quantities are: force **F** ⇒ in Newton **N**, distance **h** ⇒ in meters **m**, area **A** ⇒ in square meters **m²**, speed **u** ⇒ in meters per second **m/s**, the unit of measurement of the **dynamic viscosity** is Pascal per second (Pa•s) or Newton multiplied by second per square meter (N•s/m²).

Dividing the dynamic viscosity of the liquid by its density, you can obtain the **kinematic viscosity**. Its unit of measurement is expressed in square meter per second (m²/s). Since the given numerical values are too small, the most common used unit is 10.000 times smaller: the stokes (stox) **St**,

$$1 \text{ St} = 1 \cdot 10^{-4} \text{ m}^2/\text{s} \text{ or } 10.000 \text{ St} = 1 \text{ m}^2/\text{s}$$

as well as the additional unit centistokes **cSt**

$$1 \text{ cSt} = 1 \cdot 10^{-2} \text{ St}$$

Technical information

General Information on frequently used seal materials

Consideration of the media should be made when selecting seal and body types.

NBR should be used for air, water, neutral gases, diesel and in general it is resistant to oils and grease from -10 to +90 °C.

EPDM for hot water and steam. It is resistant to bases and acids in weak concentrations from -40 to +140 °C. EPDM seals should not be used for media containing oil.

FKM combines most of the characteristics of NBR and EPDM and is particularly suitable for hot water and hydrocarbons from -10 to +140 °C (not for steam).

PTFE is practically resistant to all media. It is rigid and is used from -20 to +180 °C.

SIGODUR (filled PTFE) and **RUBY** are stiff materials particularly suitable for heavy duty applications.

Kalrez® Spectrum™ 6375 is a compound specifically designed for the chemical process industry. This compound has excellent broad chemical resistance, good mechanical properties, and outstanding hot-air aging properties. Kalrez® 6375 is well suited for use in mixed process streams because of its excellent resistance to acids, bases and amines. It is also recommended for use in hot water, steam pure ethylene oxide and propylene oxide.

Coil power supply

It is important that the exact voltage and frequency of the coil is used for the valve to operate correctly. Provided the coil is fitted correctly on the operator and that the armature is not obstructed, the valve can be operated for an indefinite time within the temperature limitations indicated. All solenoid valves have a copper shading ring to reduce vibrations caused by alternating currents. **Remark: The same valve fitted with coils of different power may have different pressure ratings than standard combinations indicated in each datasheet in this catalogue. (e.g. UL coils or high power coils).**

Media and ambient temperatures

Temperature limits for the media in the datasheets and should be used as a guide to valve selection. Normally the maximum ambient temperature can reach +50 °C for solenoid valves with coils in class "F", +70 °C for class "H". For applications outside these limits please contact our Technical Department.

General purpose solenoid valves

Solenoid valves shown in this catalogue, either normally open or normally closed, are intended to control the flow of fluids and cannot be used as safety valves.

Valve installation

To ensure proper valve function please observe following instructions:

Water hammer or fluid hammer

Water hammer (or, more generally, fluid hammer) is a pressure surge or wave resulting when a fluid (usually a liquid but sometimes also a gas) in motion is forced to stop or change direction suddenly (momentum change).

Water hammer commonly occurs when a valve is closed suddenly at an end of a pipeline system, and a pressure wave propagates in the pipe. It may also be known as hydraulic shock.

When using liquid fluids water-hammer can occur at pressure of 6 relative bar or higher.

This pressure wave can cause major problems, from noise and vibration to pipe collapse. It is possible to reduce the effects of the water hammer pulses with accumulators and other features.

Mitigating measures:

- **Air vessels** typically have an air cushion above the fluid level, which may be regulated or separated by a bladder. Sizes of air vessels may be up to hundreds of cubic meters on large pipelines. They come in many shapes, sizes and configurations. Such vessels often are called accumulators or expansion tanks.
- **Water Hammer Arrestors** are hydropneumatic devices similar to shock absorbers that can be installed between the water pipe and the machine to absorb the shock and stop the banging.

Safety

This product is not a safety device and must not be used as sole device to prevent the over-pressure of some parts of the plant or the containment of dangerous fluids.

Always connect the coil's earth terminal to ground to ensure the safety of the user and installation. The coil provides the basic insulation only. Install the product in a protected place to prevent electric shocks.

The coil should not be energized if it is not fitted onto a valve or without a plunger inside the valve, as it would overheat and get damaged. Do not touch the energized coil: risk of high temperature.

Do not use the tubes for conveying fluid to ground electrical devices.

Before disconnecting or disassembling the valve, make sure that there is no pressure inside the tubing or the valve itself. Accidental shocks due to fall or collision may damage the operator and/or the integrity of the coil encapsulation thus causing malfunctions such as loss of insulation, seizure of the moving parts and overheating.

Installation

Check for the operating conditions on product label and on the technical documents.

Check for compatibility between medium and valve materials. In case of doubt, please contact the manufacturer.

Keep the valve operator in a vertical position, facing upwards. This prevents limescale or dirt particles in the operator tube which could restrict the armature or create excessive noise whilst operating.

Whilst tightening or unscrewing the valve must be held or revolved only and exclusively by the hexagon or the frame set (in order to avoid damage to its components such as coil, armature tube, etc.).

The recommended **tightening torque of the coil nut is 0,5 Nm maximum**, a higher torque may cause damage to the valve armature tube.

The recommended **tightening torque of the connector screw is 0,5 Nm maximum**, a higher torque may cause an excessive yield stress with consequent damages to the coil rivet and/or plastic encapsulation.

Connections

To ensure that the solenoid valve works properly, do not connect to pipework with an internal diameter less than the nominal diameter (DN) of the valve. Clean all pipework before connection to the solenoid valve: care should be taken to prevent foreign bodies – dirt or material chips – from entering the valve during the assembly phase.

Use suitable seal material on the valve threads. Where liquid sealants are used, it is important to prevent them from entering the valve and block the movement.

Flow Direction

Respect the direction of flow across the valve, shown with an arrow or by numbers on the valve body, depending on the model type.

Filtration

If the fluid contains dirt particles it is necessary to install a filter upstream of the solenoid valve. Dirt is the most frequent cause of malfunction.

Environment

Coils fitted with suitable connectors have a protection class of IP65. However, it is advisable not to use the solenoid valve outside or in very damp conditions without adequate protection. Provide sufficient ventilation for the solenoid valve. **During continuous service the coil of the solenoid valve becomes hot and should not be touched.**

Quality standards

Rotork has a management system certified to ISO 9001, ISO 14001 & OHSAS 18001.

DNV is an independent classification society. Since 1998 it has certified the compliance of Rotork Italy's quality management system (formerly M&M International srl), and recently also the compliance to the ambient and safety standards, emphasizing the effort to implement continuous improvement processes aimed at developing the business in a logic of customer satisfaction, sustainability and safety for all its employees.

Certifications and approvals



The UL Listing mark on a product signifies that the product meets UL's Standards for Safety. The UL Listing mark appears on products and components suitable for factory and field installation.

All of the products carrying a UL Listing mark are covered by UL's Follow-up services program to verify that the products continue to be manufactured in compliance with UL's Safety Requirements.

Rotork manufactures and resells valve coils and timers complying with UL 429 and 746C under M&M International brand.

The cURus Listing mark on the products indicates that the compliance is accepted both in USA and Canada.

RoHS

The Restriction of Hazardous Substances Directive (RoHS) 2011/65/EU regards the restriction of the use of Lead (Pb), Cadmium (Cd), Mercury (Hg), Hexavalent chromium (Cr6+), Polybrominated biphenyls (PBB) and Polybrominated diphenyl ether (PBDE) in electrical and electronic equipment sold in the European Union.

RoHS is meant to prevent the release of these substances into the environment and protect the human, animal and environmental health, especially during the waste treatment.

The CE mark on a product guarantees the compliance with the RoHS Directive. Since 2006 the coils manufactured under M&M brand comply with the RoHS directive with the letter 'R' before the batch number.

Miscellaneous

Upon request (to be specified at the time of the Purchase Order) Rotork can provide the following inspection documents, which are also related to requirements of the PED Directive 2014/68/EC as additional evidence of the technical requirements of supplies:

For metal parts in stainless steel AISI 316L or 304L the inspection certificate 3.1 according to the standard EN 10204 (this certificate is mandatory only for products in categories above I, see PED 2014/68/EC ANNEX I, art. 4.3).

For all products the Test Report 2.2 according to the standard EN 10204, is relevant for products in category I or SEP.

CE marking



The CE marking was introduced in 1993 upon establishment of the European Economic Area. It regulates the entire life cycle of a product: design, manufacturing, placing on the market, disposal and enables its free movement within the European market (EEA).

CE marking signifies that the product conforms with the essential applicable EC requirements, such as safety, public health, consumer protection, and gives the product the presumption of conformity.

By affixing the CE mark on a product, manufacturers and importers are declaring, at their sole responsibility, conformity with all of the legal requirements of the Directive.

EC directives

EC directives for product safety were issued to unify regulations and working practices in force in the countries of the community prior to the constitution of the European Union. The following three directives concern electrical appliances and machines in general:

Machinery directive

EMC Directive

Low Voltage Directive (2006/95/EC)

The directive 97/23/EC concerns safety of pressure bearing equipment.

The directive 2011/65/EU (RoHS) limits the use of dangerous substances in electrical and electronic equipment.

Ask Rotork Sales Department for your Declaration of compliance to EC Regulation no. 1907/2006.

M&M branded products conforming to the EC directives

Products subject to the Low Voltage Directive are given a certification by the European Community.

Rotork issues declarations of conformity for M&M branded products.

We believe that our products are components and as such do not form a part of the range of products subject to the EMC directive. However, conformity of M&M branded products to the EMC directive could change depending on the function of the product's use, of the configuration (for example the use of connectors with passive electronic components, LED etc.), or the conditions of the electrical connection. For this reason it is recommended that you check the compliance of the final product with the EMC Directive.

Coding chart

Example code

- - B - 2 - 97 - D - V - E - K - 2700 - OB1

Electrical Supply

. = AC
C = DC

Function

. = Normally closed
D = Diverting
G = Universal
L = Latching
R = Normally open
S = 2nd service

Serial Letter

B = Armature ø10 mm
C = Armature ø10 mm low power
D = Armature ø14.5 mm
E = Armature ø14.5 mm low power

Ways / Type of Valve

2 = 2/2 ways
3 = 3/2 ways
6 = For steam
8 = Various
9 = Manifold

ID Code

Valve body identification

Fixed Core Type

A = 3/2 way 1/8" gas, spherical
C = 3/2 way 1/8" gas for bicone
D = 2/2 way 1/8" gas
E = 3/2 way gasket holder

Seal Material

B = NBR	R = RUBY
E = EPDM	S = Silicone
K = Kalrez®	T = PTFE
L = Sigodur (fixed PTFE)	V = FKM

ø Orifice (mm)

A = 1.0	O = 5.5
B = 1.2	P = 6.0
C = 1.4 - 1.5 - 1.6	T = 10.0
D = 1.7 - 1.8	U = 10.5 - 11.0
E = 2.0	V = 11.5
F = 2.2 - 2.3	Z = 13.0
G = 2.5	W = 14.5 - 15.0 - 15.5 - 16.5
H = 3.0 - 3.2	X = 18.0 - 20.0
L = 4.0	Y = 24.0 - 25.0
M = 4.5	K = 40.0
N = 5.0	J = 50.0

Special Executions

A = Silver shading ring
F = Protective treatment
K = Electroless nickel plating treatment
M = Manual override
N = NPT thread
V = Speed control screw

Coil Code

Type of Connector

0A1 = With connector 600 011 00 - Not assembled on the coil
0B1 = With connector 600 001 00 - Not assembled on the coil

Site Services

Rotork understand the value of prompt, punctual and superior site services. Rotork Site Services have specialist expertise, insight and experience in service support for mission-critical flow control and instrumentation solutions for oil and gas, water and wastewater, power, chemical process and industrial applications. We offer global frontline support backed by dedicated in-house experts.

Our service solutions increase plant efficiency and reduce maintenance costs, while workshop services return equipment to as-new condition. Our experience and understanding of the flow control industry means we have extensive insight and ideas of what we can do to provide significant value to our customers and their operations.

Rotork Site Services is comprised of two main areas; Lifetime Management and Site Services. Lifetime Management is the suite of services within Rotork Site Services which help you manage the risk associated with aging assets and includes our Reliability Services offering. Site Services comprises essential actuator service, repair, maintenance and upgrades.

Rotork has specialist expertise, insight and experience in flow control.

We provide insight into how we can deliver value to our customers.

Our service solutions increase plant efficiency and reduce maintenance costs.



Site Services

Lifetime Management

The services available within Lifetime Management offer a complete solution to managing the risks associated with the life cycle of your equipment and their obsolescence (which compromise reliable performance and valuable uptime).

The aim of Lifetime Management is to provide you with constant support and minimum- to- no disruption to your production flow. It is a customisable service offering designed to seamlessly maintain and improve your assets. We manage the inherent risks associated with advances in technology, component obsolescence and ageing equipment for you. We are committed to helping customers maximise the continuous, fault-free operation and working life of their actuators. Supporting the continuous and reliable operation of your plant allows for improved performance and increases in valuable uptime.

Lifetime Management covers:

- Reliability Services
 - Health Check
 - Planned Maintenance
 - Enhanced Warranty
 - Predictive Maintenance
- Upgrade Services (retrofit)
- Planned Shutdown Support (service or run time)
- Life Cycle Services (based on years in service or run time)
- Overhauls/Refurbishment
- Customised Spares Programme
- Training
- Consultancy



Site Services

Rotork's Site Services comprises the essential on-site actuator service, repair, maintenance and upgrades part of our service offering, plus the commissioning of new actuators and applications. It includes off-site work completed at a Rotork Support Centre including recertification, automation, testing and product selection.

Our decades of experience in the industrial actuation and flow control markets means that customers can rely on us to understand their problems and to deliver reliable, economic solutions. Rotork's talented and experienced engineers have an in-depth understanding of the problems that are faced in the field and they know how to fix them.

On sites where providing evidence of valid asset certification is a legal requirement, Rotork engineers can carry out the necessary OEM level inspections and provide the statutory paperwork to comply with regulations.

- Planned Shutdown Support
- Actuator Workshop Overhaul
- Field Support
- Valve Automation Services
 - On-site
 - Off-site
- Global Support



rotork®



www.rotork.com

A full listing of our worldwide sales and service network is available on our website.

Rotork Instruments Italy Srl
24050 Orio al Serio (Bg) - ITALY Via Portico 17
tel +39 035 451161
fax +39 035 531763
email info.instruments-italy@rotork.com
web www.rotork.com

PUB124-003-00
Issue 02/21

As part of a process of on-going product development, Rotork reserves the right to amend and change specifications without prior notice. Published data may be subject to change. For the very latest version release, visit our website at www.rotork.com
The name Rotork is a registered trademark. Rotork recognises all registered trademarks. Published and produced in the UK by Rotork. Registered office: Rotork plc, Brassmill Lane, Bath, BA1 3JQ, UK. POWTG0221