

SCHISCHEK

A **rotork** Brand

Schischek Explosion Proof.

Actuators and Sensors for Hazardous (Classified) Locations.
Protection of Life. Health. Assets.

H V A C

Product Catalogue North America



IECEX



IP66
NEMA4X

www.schischek.com

Schischek Global Coverage

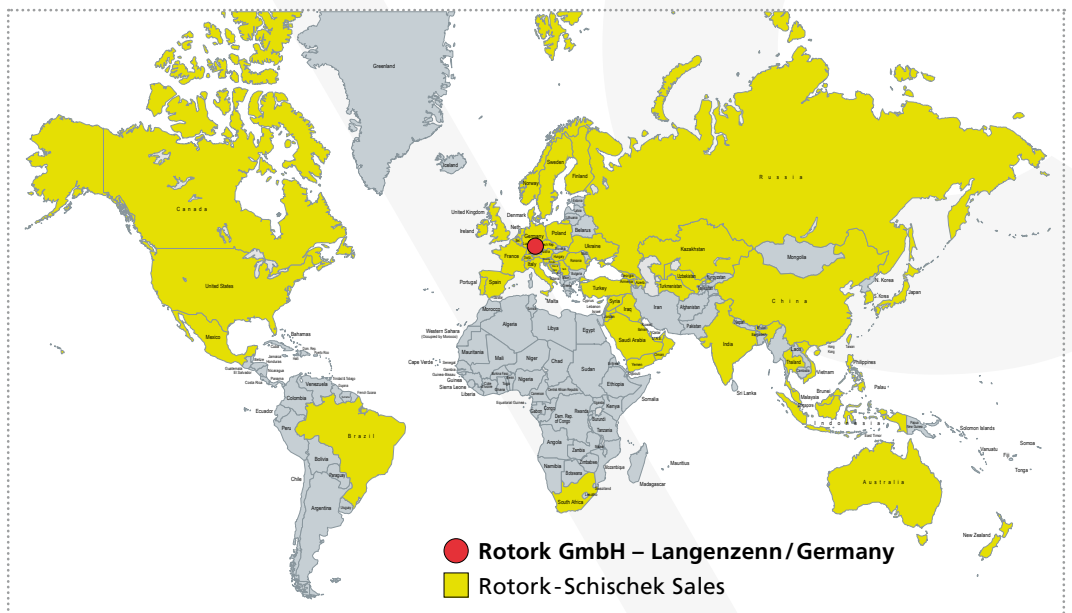

Rotork GmbH
Muehlsteig 45
90579 Langenzenn
Germany
Tel. +49 9101 9081-0
Fax +49 9101 9081-77
info@schischek.com
www.schischek.com

Rotork/Schischek Contact Worldwide:
www.schischek.com/contact/rotork-schischek-worldwide
www.rotork.com/en/contact-us/sales-service-locator

Safety, Worldwide, in Thousands of Applications!

Explosion Protection Since 1975

Since 1975 Schischek has supplied electric explosion proof products worldwide for heating, ventilation and air-conditioning, for industrial and offshore applications. Schischek Explosionproof has become an important partner for consultants, public authorities, control companies, installers, OEM's and, not least of all, the end user.

As supplier of components, we have always considered it our duty to develop products in conjunction with other control equipment. Modern Ex equipment, reliable, proven and with "state of the art" technology.

Safety is Essential

With this motto we state that explosion protection is not a question of statistics or half hearted solutions but that 100% safety must be guaranteed at all times. Explosion protection means taking on responsibility.

"There is No Little Ex Protection!"

People have confidence in us as Ex protection specialists and in you as consultant, installer and contractor. All Schischek Ex products are, therefore, type-examination certified, approved by and produced according to the very latest standards and regulations. According to type and kind of protection, our products are suitable for operation in Ex areas, zones 0, 1, 2, 20, 21 and 22, including gases, vapours, mists and dusts – of course in accordance with ATEX directives.



Schischek supplies control companies and contractors in the Building Automation market. We have developed equipment which is compatible with nearly all control systems. By combining Schischek products with conventional switching and control equipment, reliable high quality systems are implemented that conform to Ex protection standards.

Some examples of use are fire and smoke dampers, paintspray areas, exhaust systems in chemical laboratories, battery rooms, sewage treatment plants, pumping stations etc.



Harsh environmental conditions and robust quality cause stringent design / construction requirements on components and materials. A fast closing electric actuator for fire / smoke dampers of less than 3 seconds is a requirement on oil and gas platforms as well as on FPSO's. After an intense development process including trials, a completely new concept in actuator engineering was produced.

Since, thousands of Schischek actuators in special aluminium and stainless steel housings or with offshore/marine coating have been delivered and installed, moreover, the product range has been continuously enlarged and refined.



Whether you need air flow control in a pharmaceutical plant or temperature regulation of paint tanks in the car industry, Schischek offers cost-effective solutions specifically designed for control integration. Ex protection is required for applications from paint spray shops to drying stations. System compatibility with all aspects of control facilitates integrated planning from design to completion.

At the same time, safety and reliability increase in planning, installation, approval and operation. Since all equipment is maintenance-free, cost savings are realised.



In co-operation with valve and damper manufacturers, industrial control companies and contractors, Schischek products are in use worldwide. Our products are characterised by the "highest protection class, compact size and easy handling".

We can provide solutions to problems as far as Ex ventilation and precise temperature control in industrial plants are concerned.

Which Components Have to be Explosion Proof?

In the diagram below, a typical air-handling system shows which equipment is allowed in the Hazardous location and which should only be placed in the ordinary location. The diagram does not claim to be complete.

If in doubt, please do not hesitate to consult us at Schischek. We will advise you in any case. A brief discussion in the early stages of planning can avoid substantial costs in remedial work later and gives you the peace of mind that you have a safely installed operating system.

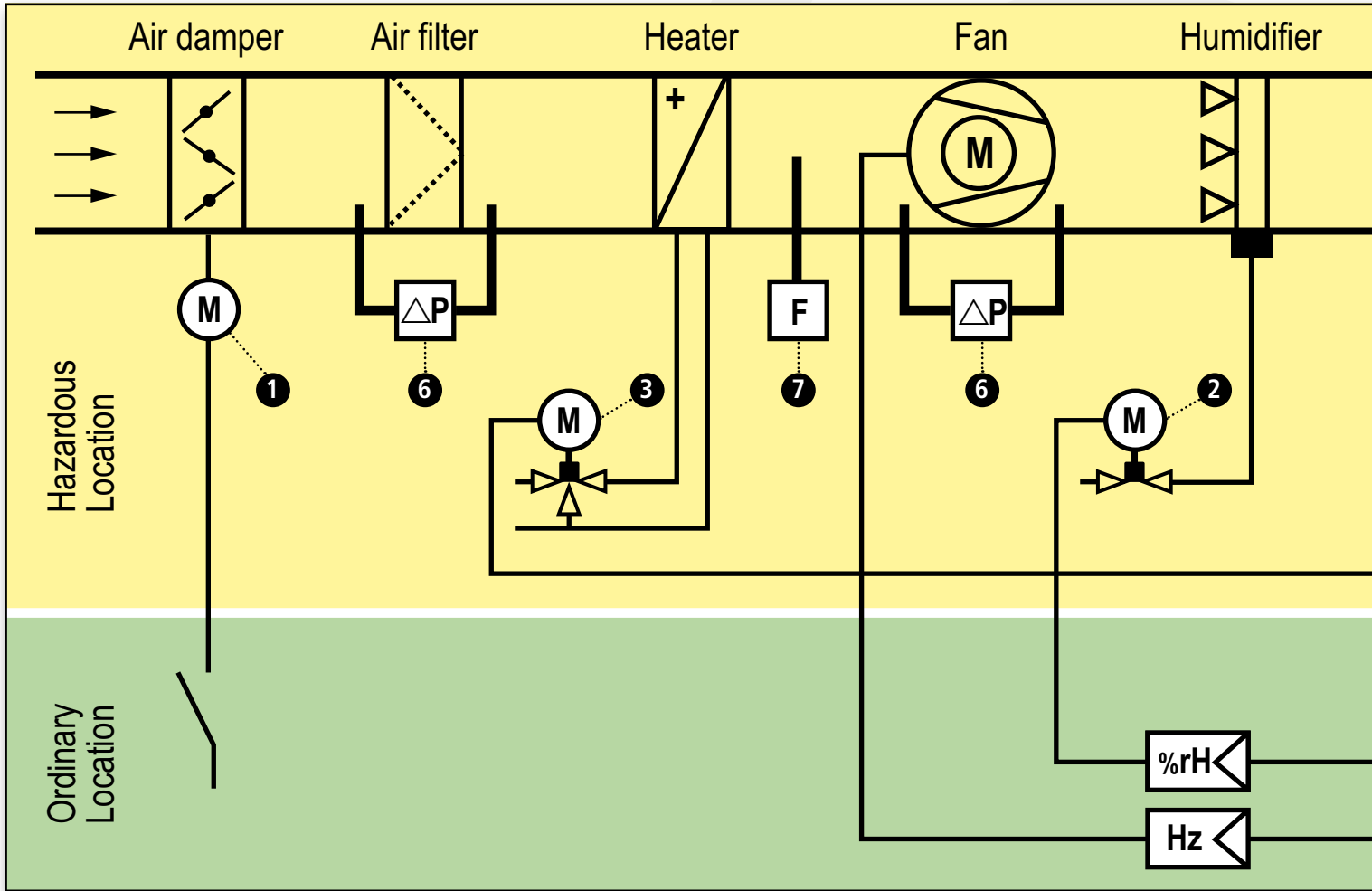

1

Quarter Turn Actuators for Dampers and Valves

ExMax
RedMax



- 45...1,350 in-lbs
- 3...150 sec/90°
- On-off, 3-pos
- modulating
- with/without spring return

2

Failsafe Linear Valve Actuators

ExMax + LIN
RedMax + LIN



- 110...670 lbf
- 0.3...1.65" stroke
- 0,1...15 sec/mm
- On-off, 3-pos
- modulating
- with spring return

3

Linear Valve Actuators

ExRun
RedRun



- 110...2,200 lbf
- 0.2...2.36" stroke
- 2...15 sec/mm
- On-off, 3-pos
- modulating

4

Temperature and Humidity Sensors

ExCos-D
RedCos-D



- -40...+257 °F
- 0...100 %rH
- full range adjustable

You should be aware of the areas of installation where an explosive atmosphere may build up. Furthermore, you should have the responsible authority classify the relevant Ex zone and in combination with type and condition of the explosive medium, you should be able to select suitable explosion proof equipment.

With Schischek products this is simple because all equipment is certified according to the highest safety standards – according to ATEX, of course!

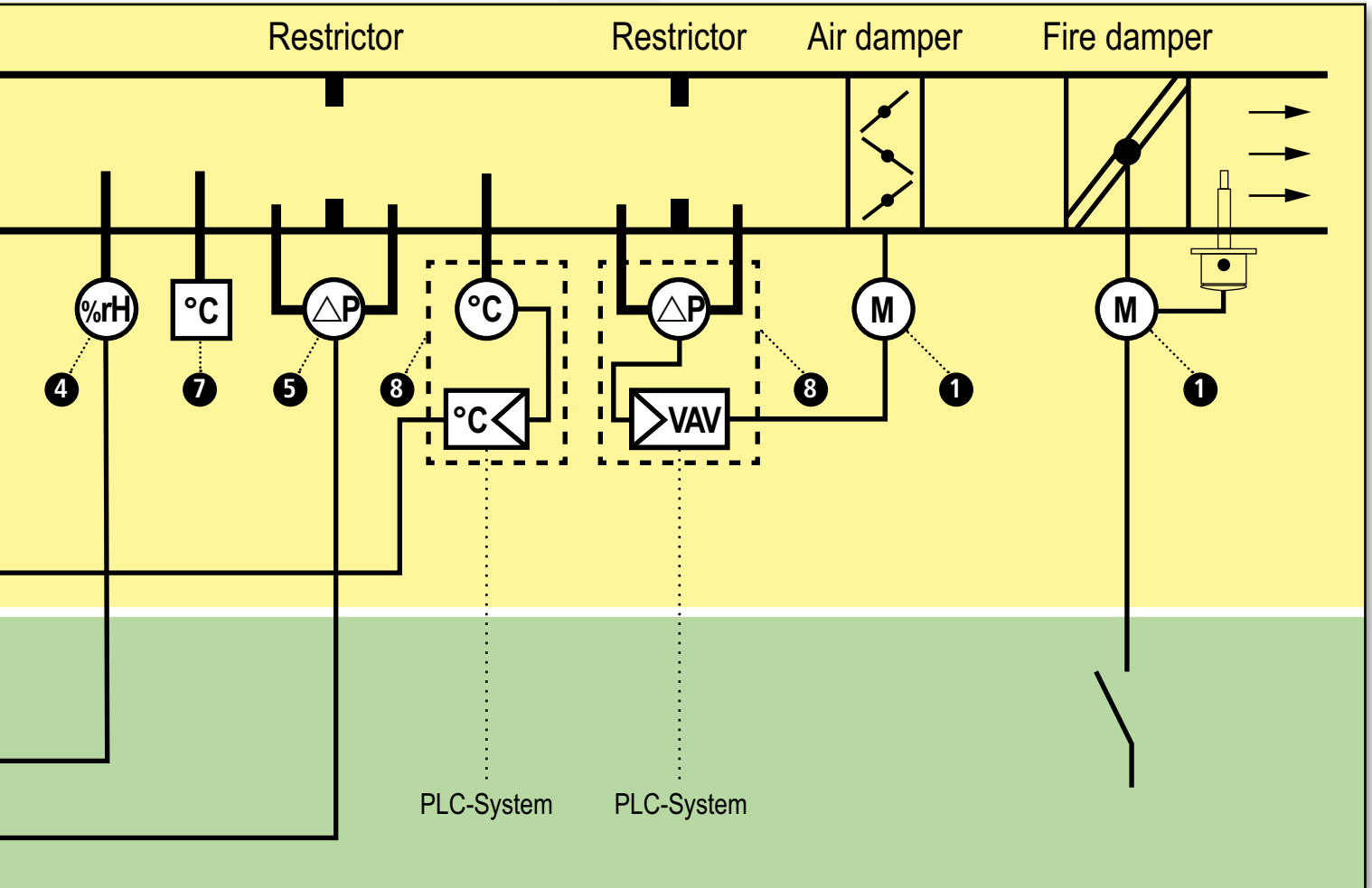

5

Pressure/Differential Pressure Sensors

ExCos-P
RedCos-P



- ± 100...± 7.500 Pa
- full range adjustable

6

Filter Monitoring, Fan Belt Protection

ExBin-P
RedBin-P



- 0...5.000 Pa
- Pressure/Differential pressure
- Fan-belt protection
- Filter protection
- 1- or 2-stage switching point

7

Thermostats, Humidistats, Frost Protection

ExBin-D
RedBin-D

- -40...+257 °F
- 0...100 %rH
- 1- or 2-stage

ExBin-FR
RedBin-FR



- +14...+59 °F
- Capillary: 118", 236"
- 1-stage switching point

8

Controller

ExReg-V
Differential pressure



- 0...100 Pa (VAV)
- 0...300 Pa (VAV)
- 0...1.000 Pa (VAV)

ExReg-D
Temperature/Humidity

- -40...+257 °F
- 0...100 %rH

Table of contents

					Installation Areas in Division/Zones							
					Gas	Dust	Gas	Dust	Gas	Dust		
					Zone 0	20	1	21	2	22	OL**	
					Cl. I	Cl. II, III	Cl. I	Cl. II, III	Cl. I	Cl. II, III	OL**	
					Div 1	Div 1	Div 1	Div 1	Div 2	Div 2		
Product Line					Page							
Approvals According to Zone System												
Approvals According to Division System												
Quarter Turn Actuators 90°												
Overview	electrical actuators with 90° angle of rotation				8-9							
ExMax	size S	45...	270 in-lbs	with/without spring return (HL*)	10		●	●	●	●		
ExMax	size M	270...	1,350 in-lbs	with/without spring return (HL*)	11		●	●	●	●		
RedMax	size S	45...	270 in-lbs	with/without spring return (HL*)	12				●	●		
RedMax	size M	270...	1,350 in-lbs	with/without spring return (HL*)	13				●	●		
InMax	size S	45...	270 in-lbs	with/without spring return (OL**)	14						●	
InMax	size M	270...	1,350 in-lbs	with/without spring return (OL**)	15						●	
Linear Valve Actuators with Spring Return with 0.30"/0.39"/0.59"/0.79"/1.18"/1.65" Stroke (Fixed)												
Overview	electrical linear actuators				16-17							
LIN-..+ ExMax..	size S, M	110...	670 lbf	with spring return (HL*)	18-19		●	●	●	●		
LIN-..+ RedMax..	size S, M	110...	670 lbf	with spring return (HL*)	18-19				●	●		
LIN-..+ InMax..	size S, M	110...	670 lbf	with spring return (OL**)	18-19						●	
Valve Actuators with 0.2" ... 2.36" (5...60 mm) Stroke												
ExRun	size S	110...	2,200 lbf	without spring return (HL*)	20-21		●	●	●	●		
RedRun	size S	110...	2,200 lbf	without spring return (HL*)	20-21				●	●		
InRun	size S	110...	2,200 lbf	without spring return (OL**)	20-21						●	
Special Options for Actuators												
Overview	special options for actuators				22-23							
Overview	heating system ExPolar for actuators				24							
ExPolar	heating system for actuators use in Ex areas down to -58 °F (-50 °C) (HL*)				25		[●]	[●]	[●]	[●]		
InPolar	heating system for actuators use in ordinary location down to -58 °F (-50 °C) (OL**)				25						●	
Controller for VAV, Pressure, Temperature, Humidity												
Overview	control system				26-27							
Analog Sensors for Temperature, Humidity, Pressure/Differential Pressure												
Overview	analog sensors				28							
Switching Sensors (Thermostats, Hygrostats, Pressostats, Fan Belt Protection, Frost Protection)												
Overview	switching (binary) sensors				29							
Special Options for Sensors												
Overview	special options for sensors				30							
Overview	heating system ExPolar for sensors				31							
ExPolar	heating system for sensors' use in Ex areas down to -58 °F (-50 °C) (HL*)				31		[●]	[●]	[●]	[●]		
InPolar	heating system for sensors' use in ordinary location down to -58 °F (-50 °C) (OL**)				31						●	
Door Holder Magnets												
ExMag	door holder magnets with 146, 292, 450 lbf force (HL*)				32		●	●	●	●		

*HL = Hazardous Location **OL = Ordinary Location (●) Zone System Only [●] ATEX only

Table of contents

		Installation Areas in Division/Zones						
		Gas	Dust	Gas	Dust	Gas	Dust	
Approvals According to Zone System		Zone 0	20	1	21	2	22	OL**
Approvals According to Division System		Cl. I	Cl. II, III	Cl. I	Cl. II, III	Cl. I	Cl. II, III	OL**
		Div 1	Div 1	Div 1	Div 1	Div 2	Div 2	
Content/ Description	Page							
Additional Information								
Ex applications	33							
Product codes / definitions	34-35							
Installation according to NEC 500 (Division system, North America)	36							
Installation according to ATEX (Zone system)	37							
Features of actuators in combination with ExPro-TT.. or programming stick	38							
Electrical installation codes according to NEC/FM/CEC	40							
Labelling of explosion proof equipment in accordance with NEC 500/505/506	41							
Explosion proof information	42							
Classification of hazardous locations	43							
Division and zone system comparison	44-45							
Certification information	46-47							
Valve automation	48-49							
Rotork Products and Site Services	50-55							
Damper actuation focused	56-57							
Typical Class I Locations respective Zones 0 and 1 (Div 1) and Zone 2 (Div 2):								
• Petroleum refineries, gasoline storage and dispensing areas		●		●		●		
• Industrial firms that use flammable liquids in dip tanks for parts cleaning or other operations		●		●		●		
• Petrochemical companies that manufacture chemicals from gas and oil		●		●		●		
• Dry cleaning plants where vapors from cleaning fluids can be present		●		●		●		
• Companies that have spraying areas where they coat products with paint or plastics		●		●		●		
• Aircraft hangars and fuel servicing areas		●		●		●		
• Utility gas plants, and operations involving storage and handling of liquefied petroleum gas or natural gas		●		●		●		
Typical Class II Locations respective Zones 20 and 21 (Div 1) and Zone 22 (Div 2):								
• Grain elevators, flour and feed mills			●		●		●	
• Plants that manufacture, use, or store magnesium or aluminum powders			●		●		●	
• Plants that have chemical or metallurgical processes of plastics, medicines, fireworks, etc.			●		●		●	
• Producers of starch or candies			●		●		●	
• Spice-grinding plants, sugar plants and cocoa plants			●		●		●	
• Coal preparation plants and other carbon-handling or processing areas			●		●		●	
Typical Class III Locations respective Zones 20 and 21 (Div 1) and Zone 22 (Div 2):								
• Textile mills, cotton gins, cotton seed mills, and flax processing plants			●		●		●	
• Any plant that shapes, pulverizes, or cuts wood and creates sawdust or flyings			●		●		●	

Introducing ExMax – Damper Actuators for Hazardous Locations !

Quarter Turn and Rotary Applications for Damper Control ...



HAZARDOUS LOCATIONS DIV. 1, 2

FAST SPRING RETURN TIME

UNIVERSAL POWER SUPPLY

STAINLESS STEEL SOLUTION

OFFSHORE/MARINE COATED VERSION

EASY INSTALLATION

COMPACT DIMENSIONS

..Max Electrical Drive Engineering with 90° Angle of Rotation

Overview ..Max Quarter-Turn Actuators

Installation Areas:

ExMax-actuators for use in hazardous location Div. 1 and zone 1, 2, 21, 22

RedMax-actuators for use in hazardous location Div. 2 and zone 2, 22

InMax-actuators for use in ordinary location

Application Areas:

Ex/Red/InMax for air and fire dampers, VAV, ball valves, control dampers

The actuator concept offers obvious advantages:

1. Small dimension, compact, easy installation, highest protection classes, cost effective
2. Universal power supply 24 to 240 Volt AC/DC, selfadjustable
3. With or without spring return (in accordance with type)
4. Robust aluminium housing, NEMA4X/IP66
5. Integrated heater for low temperatures
6. On site adjustable motor running time
7. Integrated manual override
8. Useful accessories such as retrofit limit switches
9. Actuators are to offer direct coupling

Actuators for Air Dampers

in-lbs **ExMax..**



normal wiring



ExMax., RedMax., InMax.. ¼ Turn Actuators

90° actuators from 45 to 1,350 in-lbs, with or w/o spring return (run time ~ 1, 3, 10, 20 s depending on type), for air-dampers.

Actuators for Smoke and Fire Dampers

in-lbs **ExMax..**



normal wiring



ExMax., RedMax., InMax.. ¼ Turn Actuators

90° actuators from 45 to 1,350 in-lbs, with or w/o spring return (run time ~ 1, 3, 10, 20 s depending on type), for smoke- and fire-dampers.

Actuators for VAV Control

in-lbs **ExMax..**



normal wiring



ExMax., RedMax., InMax.. ¼ Turn Actuators

90° actuators from 45 to 1,350 in-lbs, with or w/o spring return (run time ~ 1, 3, 10, 20 s depending on type), for VAV control.

Actuators for Ball Valves

in-lbs **ExMax..**



normal wiring



ExMax., RedMax., InMax.. ¼ Turn Actuators

90° actuators from 45 to 1,350 in-lbs, with or w/o spring return (run time ~ 1, 3, 10, 20 s depending on type), for ball valves.

Actuators for Butterfly Valves and Other ¼ Turn Valves

in-lbs **ExMax..**



normal wiring



ExMax., RedMax., InMax.. ¼ Turn Actuators

90° actuators from 45 to 1,350 in-lbs, with or w/o spring return (run time ~ 1, 3, 10, 20 s depending on type), for butterfly valves and other quarter turn valves.

Ordinary Location

Hazardous Location

ExMax 90° Quarter-Turn Actuators Size "S" for Class I/II/III, Div. 1, zone 1, 2, 21, 22

Explosion Proof		Features of ExMax - ... size "S"	
ExMax-... Cl. I/II/III, Div. 1 Zone 1/2/21/22 Gas + Dust certified according to UL, CSA ATEX, IECEx, EAC, INMETRO, KOSHA	Size "S" 	Description ExMax are, in accordance with type, for automation of air dampers, fire and smoke dampers, volume control, as well as for ball valves, throttle valves and other quarter-turn armatures. Scope of Delivery: 1 actuator, ~ 39.4 inch cable, allen key for manual override, 4 screws, manuals.	Basics for all ExMax-... size "S" <ul style="list-style-type: none"> • 24...240 VAC/DC self adaptable power supply • 95° angle of rotation (5° for preload) • 100% overload protected • Aluminum housing NEMA4X / IP66, cable ~ 39.4" • -40°F (-4°F for type ...F1) up to +104°F/+122°F • Emergency manual override • Squared shaft connection 0.47" x 0.47" • Dimensions (H x W x D) 8.27" x 3.74" x 3.15" • Approximate weight 8 lbs (.VAS = 16 lbs)

Quarter-Turn Actuators Without Spring Return, 24 to 240 VAC/DC, for Division 1 and Zone 1, 2, 21, 22

Type	Torque	Running Time 90°	Spring Return	Control Mode	Feedback	Features	Size
ExMax- 45.90-A	45 / 90 in-lbs	3/15/30/60 s	-	On-off, 3-pos	-	-	S
ExMax-135.270-A	135 / 270 in-lbs	3/15/30/60 s	-	On-off, 3-pos	-	-	S
ExMax- 45.90-S-A	45 / 90 in-lbs	3/15/30/60 s	-	On-off, 3-pos	2 x limit switches (5°/85°)	-	S
ExMax-135.270-S-A	135 / 270 in-lbs	3/15/30/60 s	-	On-off, 3-pos	2 x limit switches (5°/85°)	-	S
ExMax- 45.90-Y-A	45 / 90 in-lbs	7.5/15/30/60 s	-	0...10 VDC, 4...20 mA	0...10 VDC, 4...20 mA	-	S
ExMax-135.270-Y-A	135 / 270 in-lbs	7.5/15/30/60 s	-	0...10 VDC, 4...20 mA	0...10 VDC, 4...20 mA	-	S

Quarter-Turn Actuators With Spring Return, 24 to 240 VAC/DC, for Division 1 and Zone 1, 2, 21, 22

Type	Torque	Running Time 90°	Spring Return	Control Mode	Feedback	Features	Size
ExMax-45.90-F-A	45 / 90 in-lbs	3/15/30/60 s	~ 3 s / 10 s	On-off, 3-pos	-	-	S
ExMax- 135-F-A	135 in-lbs	3/15/30/60 s	~ 3 s / 10 s	On-off, 3-pos	-	-	S
ExMax-45.90-SF-A	45 / 90 in-lbs	3/15/30/60 s	~ 3 s / 10 s	On-off, 3-pos	2 x limit switches (5°/85°)	-	S
ExMax- 135-SF-A	135 in-lbs	3/15/30/60 s	~ 3 s / 10 s	On-off, 3-pos	2 x limit switches (5°/85°)	-	S
ExMax-45.90-YF-A	45 / 90 in-lbs	7.5/15/30/60 s	~ 3 s / 10 s	0...10 VDC, 4...20 mA	0...10 VDC, 4...20 mA	-	S
ExMax- 135-YF-A	135 in-lbs	7.5/15/30/60 s	~ 3 s / 10 s	0...10 VDC, 4...20 mA	0...10 VDC, 4...20 mA	-	S
ExMax-45.90-BF-A	45 / 90 in-lbs	3/15/30/60 s	~ 3 s / 10 s	On-off, 3-pos	2 x limit switches (5°/85°)	ExPro-TT... connector	S
ExMax- 135-BF-A	135 in-lbs	3/15/30/60 s	~ 3 s / 10 s	On-off, 3-pos	2 x limit switches (5°/85°)	ExPro-TT... connector	S

Quarter-Turn Actuators With Fast Spring Return, 24 to 240 VAC/DC, for Division 1 and Zone 1, 2, 21, 22

Type	Torque	Running Time 90°	Spring Return*	Control Mode	Feedback	Features	Size
ExMax- 72-F1-A	53 in-lbs	3/15/30/60 s	~ 1 s	On-off	-	-	S
ExMax-135-F1-A	106 in-lbs	3/15/30/60 s	~ 1 s	On-off	-	-	S
ExMax- 72-SF1-A	53 in-lbs	3/15/30/60 s	~ 1 s	On-off	2 x limit switches (5°/85°)	-	S
ExMax-135-SF1-A	106 in-lbs	3/15/30/60 s	~ 1 s	On-off	2 x limit switches (5°/85°)	-	S
ExMax- 72-BF1-A	53 in-lbs	3/15/30/60 s	~ 1 s	On-off	2 x limit switches (5°/85°)	ExPro-TT... connector	S
ExMax-135-BF1-A	106 in-lbs	3/15/30/60 s	~ 1 s	On-off	2 x limit switches (5°/85°)	ExPro-TT... connector	S

*At low temperatures the spring return time might vary. For further assistance please contact our sales team.

Accessories

Type	Description/Technical Data
Stick	Stick to change parameter and factory settings such as running time, torque, spring return time, force control and write protection depending on actuator
ExPro-TT-72	Safety temperature trigger for fire dampers, switching at 162°F / 72°C, with electrical connector, only connectable to ...Max-...-BF actuators!
EXC-DS1/VA	Safety temperature sensor for duct mounting, potential free contact, switching at 70°C...160°C (10°C steps)
MKK-S	Mounting bracket for junction box for actuator size S (details on request)
Junktion Box	Per hazardous location specification (details on request)
DWB-S	Angle rotation limiter for mounting on actuator size S (details on request)
KB-A	Shaft connection for North American actuators for damper shafts Ø ½" adaptable to all ..Max-.. actuators size S
KB-S	Mounting clamp for round damper shafts 0.4" to 0.75" and squared shafts 0.4" to 0.6", including bracket, connectable to all ..Max-.. actuators size S
HV-SK, HV-SL	Manual override, connectable to actuators size S. HV-SK = short version, HV-SL = long version for add. mounting of ..Box/..Switch (not suitable for ..Max-...-F1!)
AR-12-xx	Squared reduction part from 0.47" x 0.47" to shafts with 0.43" (type AR-12-11), 0.39" (type AR-12-10), 0.32" (type AR-12-08)
Valve Linkage Kits	Per valve specification

Special options and offshore kits see page 23

ExMax 90° Quarter-Turn Actuators Size "M" for Class I/II/III, Div. 1, zone 1, 2, 21, 22

Explosion Proof		Features of ExMax - ... size "M"		
ExMax... Cl. I/II/III, Div. 1 Zone 1/2/21/22 Gas + Dust certified according to UL, CSA ATEX, IECEx, EAC, INMETRO	Size "M" 	Description ExMax are, in accordance with type, for automation of air dampers, fire and smoke dampers, volume control, as well as for ball valves, throttle valves and other quarter-turn armatures. Scope of Delivery: 1 actuator, ~ 39.4 inch cable, allen key for manual override, 4 screws, manuals.	Basics for all ExMax.. size "M" <ul style="list-style-type: none"> • 24...240 VAC/DC self adaptable power supply • 95° angle of rotation (5° for preload) • 100% overload protected • Aluminum housing NEMA4X / IP66, cable ~ 39.4" • -40°F (-4°F for type ...F3) up to +104°F/+122°F • Emergency manual override • Squared shaft connection 0.63" x 0.63" • Dimensions (H x W x D) 11.34" x 5.87" x 4.57" • Approximate weight 21 lbs 	

Quarter-Turn Actuators Without Spring Return, 24 to 240 VAC/DC, for Division 1 and Zone 1, 2, 21, 22

Type	Torque	Running Time 90°	Spring Return	Control Mode	Feedback	Features	Size
ExMax-450.675-A	450 / 675 in-lbs	40/60/90/120 s	-	On-off, 3-pos	-	-	M
ExMax- 900-A	900 in-lbs	40/60/90/120 s	-	On-off, 3-pos	-	-	M
ExMax- 1350-A	1,350 in-lbs	40/60/90/120 s	-	On-off, 3-pos	-	-	M
ExMax-450.675-S-A	450 / 675 in-lbs	40/60/90/120 s	-	On-off, 3-pos	2 x limit switches (5° / 85°)	-	M
ExMax- 900-S-A	900 in-lbs	40/60/90/120 s	-	On-off, 3-pos	2 x limit switches (5° / 85°)	-	M
ExMax- 1350-S-A	1,350 in-lbs	40/60/90/120 s	-	On-off, 3-pos	2 x limit switches (5° / 85°)	-	M
ExMax-450.675-Y-A	450 / 675 in-lbs	40/60/90/120 s	-	0...10 VDC, 4...20 mA	0...10 VDC, 4...20 mA	-	M
ExMax- 900-Y-A	900 in-lbs	40/60/90/120 s	-	0...10 VDC, 4...20 mA	0...10 VDC, 4...20 mA	-	M

Quarter-Turn Actuators With Spring Return, 24 to 240 VAC/DC, for Division 1 and Zone 1, 2, 21, 22

Type	Torque	Running Time 90°	Spring Return	Control Mode	Feedback	Features	Size
ExMax-270-F-A	270 in-lbs	40/60/90/120 s	~ 20 s	On-off, 3-pos	-	-	M
ExMax-450-F-A	450 in-lbs	40/60/90/120 s	~ 20 s	On-off, 3-pos	-	-	M
ExMax-540-F-A	540 in-lbs	40/60/90/120 s	~ 20 s	On-off, 3-pos	-	-	M
ExMax-270-SF-A	270 in-lbs	40/60/90/120 s	~ 20 s	On-off, 3-pos	2 x limit switches (5° / 85°)	-	M
ExMax-450-SF-A	450 in-lbs	40/60/90/120 s	~ 20 s	On-off, 3-pos	2 x limit switches (5° / 85°)	-	M
ExMax-540-SF-A	540 in-lbs	40/60/90/120 s	~ 20 s	On-off, 3-pos	2 x limit switches (5° / 85°)	-	M
ExMax-270-YF-A	270 in-lbs	40/60/90/120 s	~ 20 s	0...10 VDC, 4...20 mA	0...10 VDC, 4...20 mA	-	M
ExMax-450-YF-A	450 in-lbs	40/60/90/120 s	~ 20 s	0...10 VDC, 4...20 mA	0...10 VDC, 4...20 mA	-	M
ExMax-270-BF-A	270 in-lbs	40/60/90/120 s	~ 20 s	On-off, 3-pos	2 x limit switches (5° / 85°)	ExPro-TT... connector	M
ExMax-450-BF-A	450 in-lbs	40/60/90/120 s	~ 20 s	On-off, 3-pos	2 x limit switches (5° / 85°)	ExPro-TT... connector	M
ExMax-540-BF-A	540 in-lbs	40/60/90/120 s	~ 20 s	On-off, 3-pos	2 x limit switches (5° / 85°)	ExPro-TT... connector	M

Quarter-Turn Actuators With Fast Spring Return, 24 to 240 VAC/DC, for Division 1 and Zone 1, 2, 21, 22

Type	Torque	Running Time 90°	Spring Return*	Control Mode	Feedback	Features	Size
ExMax-270-F3-A	216 in-lbs	40/60/90/120 s	~ 3 s	On-off	-	-	M
ExMax-450-F3-A	360 in-lbs	40/60/90/120 s	~ 3 s	On-off	-	-	M
ExMax-270-SF3-A	216 in-lbs	40/60/90/120 s	~ 3 s	On-off	2 x limit switches (5° / 85°)	-	M
ExMax-450-SF3-A	360 in-lbs	40/60/90/120 s	~ 3 s	On-off	2 x limit switches (5° / 85°)	-	M
ExMax-270-BF3-A	216 in-lbs	40/60/90/120 s	~ 3 s	On-off	2 x limit switches (5° / 85°)	ExPro-TT... connector	M
ExMax-450-BF3-A	360 in-lbs	40/60/90/120 s	~ 3 s	On-off	2 x limit switches (5° / 85°)	ExPro-TT... connector	M

*At low temperatures the spring return time might vary. For further assistance please contact our sales team.

Accessories

Type	Description/Technical Data
Stick	Stick to change parameter and factory settings such as running time, torque, spring return time, force control and write protection depending on actuator
ExPro-TT-72	Safety temperature trigger for fire dampers, switching at 162°F / 72°C, with electrical connector, only connectable to ..Max-..BF actuators!
EXC-DS1/VA	Safety temperature sensor for duct mounting, potential free contact, switching at 70°C...160°C (10°C steps)
MKK-M	Mounting bracket for junction box for actuator size M (details on request)
Junktion Box	Per hazardous location specification (details on request)
DWB-M	Angle rotation limiter for mounting on actuator size M (details on request)
HV-MK	Manual override, connectable to actuators size M (not suitable for ..Max-..F3!)
AR-16-xx	Squared reduction part from 0.63" x 0.63" to shafts with 0.55" (type AR-16-14), 0.47" (type AR-16-12)
Valve Linkage Kits	Per valve specification

Special options and offshore kits see page 23

RedMax 90° Quarter-Turn Actuators Size "S" for Class I/II/III, Div. 2, zone 2, 22

Explosion Proof		Features of RedMax - ... size "S"	
RedMax-... Cl. I/II/III, Div. 2 Zone 2, 22 Gas + Dust certified according to UL, CSA ATEX, IECEx, EAC	Size "S" 	Description RedMax are, in accordance with type, for automation of air dampers, fire and smoke dampers, volume control, as well as for ball valves, throttle valves and other quarter-turn armatures. Scope of Delivery: 1 actuator, ~ 39.4 inch cable, allen key for manual override, 4 screws, manuals.	Basics for all RedMax-.. size "S" <ul style="list-style-type: none"> • 24...240 VAC/DC self adaptable power supply • 95° angle of rotation (5° for preload) • 100% overload protected • Aluminum housing NEMA4X / IP66, cable ~ 39.4" • -40°F (-4°F for type ...F1) up to +104°F/+122°F • Emergency manual override • Squared shaft connection 0.47" x 0.47" • Dimensions (H x W x D) 8.27" x 3.74" x 3.15" • Approximate weight 8 lbs (.VAS = 16 lbs)

Quarter-Turn Actuators Without Spring Return, 24 to 240 VAC/DC, for Division 2 and Zone 2, 22

Type	Torque	Running Time 90°	Spring Return	Control Mode	Feedback	Features	Size
RedMax- 45.90-A	45 / 90 in-lbs	3/15/30/60 s	-	On-off, 3-pos	-	-	S
RedMax-135.270-A	135 / 270 in-lbs	3/15/30/60 s	-	On-off, 3-pos	-	-	S
RedMax- 45.90-S-A	45 / 90 in-lbs	3/15/30/60 s	-	On-off, 3-pos	2 x limit switches (5°/85°)	-	S
RedMax-135.270-S-A	135 / 270 in-lbs	3/15/30/60 s	-	On-off, 3-pos	2 x limit switches (5°/85°)	-	S
RedMax- 45.90-Y-A	45 / 90 in-lbs	7.5/15/30/60 s	-	0...10 VDC, 4...20 mA	0...10 VDC, 4...20 mA	-	S
RedMax-135.270-Y-A	135 / 270 in-lbs	7.5/15/30/60 s	-	0...10 VDC, 4...20 mA	0...10 VDC, 4...20 mA	-	S

Quarter-Turn Actuators With Spring Return, 24 to 240 VAC/DC, for Division 2 and Zone 2, 22

Type	Torque	Running Time 90°	Spring Return	Control Mode	Feedback	Features	Size
RedMax-45.90-F-A	45 / 90 in-lbs	3/15/30/60 s	~ 3 s / 10 s	On-off, 3-pos	-	-	S
RedMax- 135-F-A	135 in-lbs	3/15/30/60 s	~ 3 s / 10 s	On-off, 3-pos	-	-	S
RedMax-45.90-SF-A	45 / 90 in-lbs	3/15/30/60 s	~ 3 s / 10 s	On-off, 3-pos	2 x limit switches (5°/85°)	-	S
RedMax- 135-SF-A	135 in-lbs	3/15/30/60 s	~ 3 s / 10 s	On-off, 3-pos	2 x limit switches (5°/85°)	-	S
RedMax-45.90-YF-A	45 / 90 in-lbs	7.5/15/30/60 s	~ 3 s / 10 s	0...10 VDC, 4...20 mA	0...10 VDC, 4...20 mA	-	S
RedMax- 135-YF-A	135 in-lbs	7.5/15/30/60 s	~ 3 s / 10 s	0...10 VDC, 4...20 mA	0...10 VDC, 4...20 mA	-	S
RedMax-45.90-BF-A	45 / 90 in-lbs	3/15/30/60 s	~ 3 s / 10 s	On-off, 3-pos	2 x limit switches (5°/85°)	ExPro-TT... connector	S
RedMax- 135-BF-A	135 in-lbs	3/15/30/60 s	~ 3 s / 10 s	On-off, 3-pos	2 x limit switches (5°/85°)	ExPro-TT... connector	S

Quarter-Turn Actuators With Fast Spring Return, 24 to 240 VAC/DC, for Division 2 and Zone 2, 22

Type	Torque	Running Time 90°	Spring Return*	Control Mode	Feedback	Features	Size
RedMax- 72-F1-A	53 in-lbs	3/15/30/60 s	~ 1 s	On-off	-	-	S
RedMax-135-F1-A	106 in-lbs	3/15/30/60 s	~ 1 s	On-off	-	-	S
RedMax- 72-SF1-A	53 in-lbs	3/15/30/60 s	~ 1 s	On-off	2 x limit switches (5°/85°)	-	S
RedMax-135-SF1-A	106 in-lbs	3/15/30/60 s	~ 1 s	On-off	2 x limit switches (5°/85°)	-	S
RedMax- 72-BF1-A	53 in-lbs	3/15/30/60 s	~ 1 s	On-off	2 x limit switches (5°/85°)	ExPro-TT... connector	S
RedMax-135-BF1-A	106 in-lbs	3/15/30/60 s	~ 1 s	On-off	2 x limit switches (5°/85°)	ExPro-TT... connector	S

*At low temperatures the spring return time might vary. For further assistance please contact our sales team.

Accessories

Type	Description/Technical Data
Stick	Stick to change parameter and factory settings such as running time, torque, spring return time, force control and write protection depending on actuator
ExPro-TT-72	Safety temperature trigger for fire dampers, switching at 162°F / 72°C, with electrical connector, only connectable to ...Max-...-BF actuators!
EXC-DS1/VA	Safety temperature sensor for duct mounting, potential free contact, switching at 70°C...160°C (10°C steps)
MKK-S	Mounting bracket for junction box for actuator size S (details on request)
Junktion Box	Per hazardous location specification (details on request)
DWB-S	Angle rotation limiter for mounting on actuator size S (details on request)
KB-A	Shaft connection for North American actuators for damper shafts Ø ½" adaptable to all ..Max-.. actuators size S
KB-S	Mounting clamp for round damper shafts 0.4" to 0.75" and squared shafts 0.4" to 0.6", including bracket, connectable to all ..Max-.. actuators size S
HV-SK, HV-SL	Manual override, connectable to actuators size S. HV-SK = short version, HV-SL = long version for add. mounting of ..Box/..Switch (not suitable for ..Max-...-F1!)
AR-12-xx	Squared reduction part from 0.47" x 0.47" to shafts with 0.43" (type AR-12-11), 0.39" (type AR-12-10), 0.32" (type AR-12-08)
Valve Linkage Kits	Per valve specification

Special options and offshore kits see page 23

RedMax 90° Quarter-Turn Actuators Size "M" for Class I/II/III, Div. 2, zone 2, 22

Explosion Proof

Features of RedMax - ... size "M"

RedMax-...

Cl. I/II/III, Div. 2
Zone 2, 22
Gas + Dust
certified according to
UL, CSA
ATEX, IECEx,
EAC

Size "M"



Description

RedMax are, in accordance with type, for automation of air dampers, fire and smoke dampers, volume control, as well as for ball valves, throttle valves and other quarter-turn armatures.

Scope of Delivery:

1 actuator, ~ 39.4 inch cable, allen key for manual override, 4 screws, manuals.

Basics for all RedMax-.. size "M"

- **24...240 VAC/DC** self adaptable power supply
- 95° angle of rotation (5° for preload)
- 100% overload protected
- Aluminum housing NEMA4X / IP66, cable ~ 39.4"
- -40°F (-4°F for type ...F3) up to +104°F/+122°F
- Emergency manual override
- Squared shaft connection 0.63" x 0.63"
- Dimensions (H x W x D) 11.34" x 5.87" x 4.57"
- Approximate weight 21 lbs

Quarter-Turn Actuators Without Spring Return, 24 to 240 VAC/DC, for Division 2 and Zone 2, 22

Type	Torque	Running Time 90°	Spring Return	Control Mode	Feedback	Features	Size
RedMax-450.675-A	450 / 675 in-lbs	40/60/90/120 s	-	On-off, 3-pos	-	-	M
RedMax- 900-A	900 in-lbs	40/60/90/120 s	-	On-off, 3-pos	-	-	M
RedMax- 1350-A	1,350 in-lbs	40/60/90/120 s	-	On-off, 3-pos	-	-	M
RedMax-450.675-S-A	450 / 675 in-lbs	40/60/90/120 s	-	On-off, 3-pos	2 x limit switches (5° / 85°)	-	M
RedMax- 900-S-A	900 in-lbs	40/60/90/120 s	-	On-off, 3-pos	2 x limit switches (5° / 85°)	-	M
RedMax- 1350-S-A	1,350 in-lbs	40/60/90/120 s	-	On-off, 3-pos	2 x limit switches (5° / 85°)	-	M
RedMax-450.675-Y-A	450 / 675 in-lbs	40/60/90/120 s	-	0...10 VDC, 4...20 mA	0...10 VDC, 4...20 mA	-	M
RedMax- 900-Y-A	900 in-lbs	40/60/90/120 s	-	0...10 VDC, 4...20 mA	0...10 VDC, 4...20 mA	-	M

Quarter-Turn Actuators With Spring Return, 24 to 240 VAC/DC, for Division 2 and Zone 2, 22

Type	Torque	Running Time 90°	Spring Return	Control Mode	Feedback	Features	Size
RedMax-270-F-A	270 in-lbs	40/60/90/120 s	~ 20 s	On-off, 3-pos	-	-	M
RedMax-450-F-A	450 in-lbs	40/60/90/120 s	~ 20 s	On-off, 3-pos	-	-	M
RedMax-540-F-A	540 in-lbs	40/60/90/120 s	~ 20 s	On-off, 3-pos	-	-	M
RedMax-270-SF-A	270 in-lbs	40/60/90/120 s	~ 20 s	On-off, 3-pos	2 x limit switches (5° / 85°)	-	M
RedMax-450-SF-A	450 in-lbs	40/60/90/120 s	~ 20 s	On-off, 3-pos	2 x limit switches (5° / 85°)	-	M
RedMax-540-SF-A	540 in-lbs	40/60/90/120 s	~ 20 s	On-off, 3-pos	2 x limit switches (5° / 85°)	-	M
RedMax-270-YF-A	270 in-lbs	40/60/90/120 s	~ 20 s	0...10 VDC, 4...20 mA	0...10 VDC, 4...20 mA	-	M
RedMax-450-YF-A	450 in-lbs	40/60/90/120 s	~ 20 s	0...10 VDC, 4...20 mA	0...10 VDC, 4...20 mA	-	M
RedMax-270-BF-A	270 in-lbs	40/60/90/120 s	~ 20 s	On-off, 3-pos	2 x limit switches (5° / 85°)	ExPro-TT... connector	M
RedMax-450-BF-A	450 in-lbs	40/60/90/120 s	~ 20 s	On-off, 3-pos	2 x limit switches (5° / 85°)	ExPro-TT... connector	M
RedMax-540-BF-A	540 in-lbs	40/60/90/120 s	~ 20 s	On-off, 3-pos	2 x limit switches (5° / 85°)	ExPro-TT... connector	M

Quarter-Turn Actuators With Fast Spring Return, 24 to 240 VAC/DC, for Division 2 and Zone 2, 22

Type	Torque	Running Time 90°	Spring Return*	Control Mode	Feedback	Features	Size
RedMax-270-F3-A	216 in-lbs	40/60/90/120 s	~ 3 s	On-off	-	-	M
RedMax-450-F3-A	360 in-lbs	40/60/90/120 s	~ 3 s	On-off	-	-	M
RedMax-270-SF3-A	216 in-lbs	40/60/90/120 s	~ 3 s	On-off	2 x limit switches (5° / 85°)	-	M
RedMax-450-SF3-A	360 in-lbs	40/60/90/120 s	~ 3 s	On-off	2 x limit switches (5° / 85°)	-	M
RedMax-270-BF3-A	216 in-lbs	40/60/90/120 s	~ 3 s	On-off	2 x limit switches (5° / 85°)	ExPro-TT... connector	M
RedMax-450-BF3-A	360 in-lbs	40/60/90/120 s	~ 3 s	On-off	2 x limit switches (5° / 85°)	ExPro-TT... connector	M

*At low temperatures the spring return time might vary. For further assistance please contact our sales team.

Accessories

Type	Description/Technical Data
Stick	Stick to change parameter and factory settings such as running time, torque, spring return time, force control and write protection depending on actuator
ExPro-TT-72	Safety temperature trigger for fire dampers, switching at 162°F / 72°C, with electrical connector, only connectable to ..Max-..BF actuators!
EXC-DS1/VA	Safety temperature sensor for duct mounting, potential free contact, switching at 70°C...160°C (10°C steps)
MKK-M	Mounting bracket for junction box for actuator size M (details on request)
Junktion Box	Per hazardous location specification (details on request)
DWB-M	Angle rotation limiter for mounting on actuator size M (details on request)
HV-MK	Manual override, connectable to actuators size M (not suitable for ..Max-..F3!)
AR-16-xx	Squared reduction part from 0.63" x 0.63" to shafts with 0.55" (type AR-16-14), 0.47" (type AR-16-12)
Valve Linkage Kits	Per valve specification

Special options and offshore kits see page 23

InMax 90° Quarter-Turn Actuators Size "S" for Ordinary Locations

Industrial		Features of InMax - ... size "S"	
InMax-... NOT explosion proof and only for use in ordinary locations certified according to general purpose standard NEMA4X / IP66	Size "S" 	Description InMax are, in accordance with type, for automation of air dampers, fire and smoke dampers, volume control, as well as for ball valves, throttle valves and other quarter-turn armatures. Scope of Delivery: 1 actuator, ~ 39.4 inch cable, allen key for manual override, 4 screws, manuals.	Basics for all InMax-.. size "S" <ul style="list-style-type: none"> • 24...240 VAC/DC self adaptable power supply • 95° angle of rotation (5° for preload) • 100% overload protected • Aluminum housing NEMA4X/IP66, cable ~ 39.4" • -40°F (-4°F for type ...F1) up to +122°F • Emergency manual override • Squared shaft connection 0.47" x 0.47" • Dimensions (H x W x D) 8.27" x 3.74" x 3.15" • Approximate weight 8 lbs (.VAS = 16 lbs)

Quarter-Turn Actuators Without Spring Return, 24 to 240 VAC/DC, for Ordinary Location

Type	Torque	Running Time 90°	Spring Return	Control Mode	Feedback	Features	Size
InMax- 45.90-A	45 / 90 in-lbs	3/15/30/60 s	-	On-off, 3-pos	-	-	S
InMax-135.270-A	135 / 270 in-lbs	3/15/30/60 s	-	On-off, 3-pos	-	-	S
InMax- 45.90-S-A	45 / 90 in-lbs	3/15/30/60 s	-	On-off, 3-pos	2 x limit switches (5°/85°)	-	S
InMax-135.270-S-A	135 / 270 in-lbs	3/15/30/60 s	-	On-off, 3-pos	2 x limit switches (5°/85°)	-	S
InMax- 45.90-Y-A	45 / 90 in-lbs	7.5/15/30/60 s	-	0...10 VDC, 4...20 mA	0...10 VDC, 4...20 mA	-	S
InMax-135.270-Y-A	135 / 270 in-lbs	7.5/15/30/60 s	-	0...10 VDC, 4...20 mA	0...10 VDC, 4...20 mA	-	S

Quarter-Turn Actuators With Spring Return, 24 to 240 VAC/DC, for Ordinary Location

Type	Torque	Running Time 90°	Spring Return	Control Mode	Feedback	Features	Size
InMax-45.90-F-A	45 / 90 in-lbs	3/15/30/60 s	~ 3 s / 10 s	On-off, 3-pos	-	-	S
InMax- 135-F-A	135 in-lbs	3/15/30/60 s	~ 3 s / 10 s	On-off, 3-pos	-	-	S
InMax-45.90-SF-A	45 / 90 in-lbs	3/15/30/60 s	~ 3 s / 10 s	On-off, 3-pos	2 x limit switches (5°/85°)	-	S
InMax- 135-SF-A	135 in-lbs	3/15/30/60 s	~ 3 s / 10 s	On-off, 3-pos	2 x limit switches (5°/85°)	-	S
InMax-45.90-YF-A	45 / 90 in-lbs	7.5/15/30/60 s	~ 3 s / 10 s	0...10 VDC, 4...20 mA	0...10 VDC, 4...20 mA	-	S
InMax- 135-YF-A	135 in-lbs	7.5/15/30/60 s	~ 3 s / 10 s	0...10 VDC, 4...20 mA	0...10 VDC, 4...20 mA	-	S
InMax-45.90-BF-A	45 / 90 in-lbs	3/15/30/60 s	~ 3 s / 10 s	On-off, 3-pos	2 x limit switches (5°/85°)	InPro-TT... connector	S
InMax- 135-BF-A	135 in-lbs	3/15/30/60 s	~ 3 s / 10 s	On-off, 3-pos	2 x limit switches (5°/85°)	InPro-TT... connector	S

Quarter-Turn Actuators With Fast Spring Return, 24 to 240 VAC/DC, for Ordinary Location

Type	Torque	Running Time 90°	Spring Return*	Control Mode	Feedback	Features	Size
InMax- 72-F1-A	53 in-lbs	3/15/30/60 s	~ 1 s	On-off	-	-	S
InMax-135-F1-A	106 in-lbs	3/15/30/60 s	~ 1 s	On-off	-	-	S
InMax- 72-SF1-A	53 in-lbs	3/15/30/60 s	~ 1 s	On-off	2 x limit switches (5°/85°)	-	S
InMax-135-SF1-A	106 in-lbs	3/15/30/60 s	~ 1 s	On-off	2 x limit switches (5°/85°)	-	S
InMax- 72-BF1-A	53 in-lbs	3/15/30/60 s	~ 1 s	On-off	2 x limit switches (5°/85°)	InPro-TT... connector	S
InMax-135-BF1-A	106 in-lbs	3/15/30/60 s	~ 1 s	On-off	2 x limit switches (5°/85°)	InPro-TT... connector	S

*At low temperatures the spring return time might vary. For further assistance please contact our sales team.

Accessories

Type	Description/Technical Data
Stick	Stick to change parameter and factory settings such as running time, torque, spring return time, force control and write protection depending on actuator
InPro-TT-72	Temperature trigger for fire dampers, switching at 162°F / 72°C, with electrical connector, only connectable to InMax-...-BF actuators!
EXC-DS1/VA	Safety temperature sensor for duct mounting, potential free contact, switching at 70°C...160°C (10°C steps)
MKK-S	Mounting bracket for junction box for actuator size S (details on request)
Junktion Box	Per specification (details on request)
DWB-S	Angle rotation limiter for mounting on actuator size S (details on request)
KB-A	Shaft connection for North American actuators for damper shafts Ø ½" adaptable to all ..Max-.. actuators size S
KB-S	Mounting clamp for round damper shafts 0.4" to 0.75" and squared shafts 0.4" to 0.6", including bracket, connectable to all ..Max-.. actuators size S
HV-SK, HV-SL	Manual override, connectable to actuators size S. HV-SK = short version, HV-SL = long version for add. mounting of ..Box/..Switch (not suitable for ..Max-...F1!)
AR-12-xx	Squared reduction part from 0.47" x 0.47" to shafts with 0.43" (type AR-12-11), 0.39" (type AR-12-10), 0.32" (type AR-12-08)
Valve Linkage Kits	Per valve specification

Special options and offshore kits see page 23

InMax 90° Quarter-Turn Actuators Size "M" for Ordinary Locations

Industrial

Features of InMax - ... size "M"

InMax...	Size "M"	Description	Basics for all InMax.. size "M"
NOT explosion proof and only for use in ordinary locations certified according to general purpose standard NEMA4X / IP66		InMax are, in accordance with type, for automation of air dampers, fire and smoke dampers, volume control, as well as for ball valves, throttle valves and other quarter-turn armatures. Scope of Delivery: 1 actuator, ~ 39.4 inch cable, allen key for manual override, 4 screws, manuals.	<ul style="list-style-type: none"> • 24...240 VAC/DC self adaptable power supply • 95° angle of rotation (5° for preload) • 100% overload protected • Aluminum housing NEMA4X/IP66, cable ~ 39.4" • -40°F (-4°F for type ...F3) up to +122°F • Emergency manual override • Squared shaft connection 0.63" x 0.63" • Dimensions (H x W x D) 11.34" x 5.87" x 4.57" • Approximate weight 21 lbs

Quarter-Turn Actuators Without Spring Return, 24 to 240 VAC/DC, for Ordinary Location

Type	Torque	Running Time 90°	Spring Return	Control Mode	Feedback	Features	Size
InMax-450.675-A	450 / 675 in-lbs	40/60/90/120 s	-	On-off, 3-pos	-	-	M
InMax- 900-A	900 in-lbs	40/60/90/120 s	-	On-off, 3-pos	-	-	M
InMax- 1350-A	1,350 in-lbs	40/60/90/120 s	-	On-off, 3-pos	-	-	M
InMax-450.675-S-A	450 / 675 in-lbs	40/60/90/120 s	-	On-off, 3-pos	2 x limit switches (5° / 85°)	-	M
InMax- 900-S-A	900 in-lbs	40/60/90/120 s	-	On-off, 3-pos	2 x limit switches (5° / 85°)	-	M
InMax- 1350-S-A	1,350 in-lbs	40/60/90/120 s	-	On-off, 3-pos	2 x limit switches (5° / 85°)	-	M
InMax-450.675-Y-A	450 / 675 in-lbs	40/60/90/120 s	-	0...10 VDC, 4...20 mA	0...10 VDC, 4...20 mA	-	M
InMax- 900-Y-A	900 in-lbs	40/60/90/120 s	-	0...10 VDC, 4...20 mA	0...10 VDC, 4...20 mA	-	M

Quarter-Turn Actuators With Spring Return, 24 to 240 VAC/DC, for Ordinary Location

Type	Torque	Running Time 90°	Spring Return	Control Mode	Feedback	Features	Size
InMax-270-F-A	270 in-lbs	40/60/90/120 s	~ 20 s	On-off, 3-pos	-	-	M
InMax-450-F-A	450 in-lbs	40/60/90/120 s	~ 20 s	On-off, 3-pos	-	-	M
InMax-540-F-A	540 in-lbs	40/60/90/120 s	~ 20 s	On-off, 3-pos	-	-	M
InMax-270-SF-A	270 in-lbs	40/60/90/120 s	~ 20 s	On-off, 3-pos	2 x limit switches (5° / 85°)	-	M
InMax-450-SF-A	450 in-lbs	40/60/90/120 s	~ 20 s	On-off, 3-pos	2 x limit switches (5° / 85°)	-	M
InMax-540-SF-A	540 in-lbs	40/60/90/120 s	~ 20 s	On-off, 3-pos	2 x limit switches (5° / 85°)	-	M
InMax-270-YF-A	270 in-lbs	40/60/90/120 s	~ 20 s	0...10 VDC, 4...20 mA	0...10 VDC, 4...20 mA	-	M
InMax-450-YF-A	450 in-lbs	40/60/90/120 s	~ 20 s	0...10 VDC, 4...20 mA	0...10 VDC, 4...20 mA	-	M
InMax-270-BF-A	270 in-lbs	40/60/90/120 s	~ 20 s	On-off, 3-pos	2 x limit switches (5° / 85°)	InPro-TT... connector	M
InMax-450-BF-A	450 in-lbs	40/60/90/120 s	~ 20 s	On-off, 3-pos	2 x limit switches (5° / 85°)	InPro-TT... connector	M
InMax-540-BF-A	540 in-lbs	40/60/90/120 s	~ 20 s	On-off, 3-pos	2 x limit switches (5° / 85°)	InPro-TT... connector	M

Quarter-Turn Actuators With Fast Spring Return, 24 to 240 VAC/DC, for Ordinary Location

Type	Torque	Running Time 90°	Spring Return*	Control Mode	Feedback	Features	Size
InMax-270-F3-A	216 in-lbs	40/60/90/120 s	~ 3 s	On-off	-	-	M
InMax-450-F3-A	360 in-lbs	40/60/90/120 s	~ 3 s	On-off	-	-	M
InMax-270-SF3-A	216 in-lbs	40/60/90/120 s	~ 3 s	On-off	2 x limit switches (5° / 85°)	-	M
InMax-450-SF3-A	360 in-lbs	40/60/90/120 s	~ 3 s	On-off	2 x limit switches (5° / 85°)	-	M
InMax-270-BF3-A	216 in-lbs	40/60/90/120 s	~ 3 s	On-off	2 x limit switches (5° / 85°)	InPro-TT... connector	M
InMax-450-BF3-A	360 in-lbs	40/60/90/120 s	~ 3 s	On-off	2 x limit switches (5° / 85°)	InPro-TT... connector	M

*At low temperatures the spring return time might vary. For further assistance please contact our sales team.

Accessories

Type	Description/Technical Data
Stick	Stick to change parameter and factory settings such as running time, torque, spring return time, force control and write protection depending on actuator
InPro-TT-72	Temperature trigger for fire dampers, switching at 162°F / 72°C, with electrical connector, only connectable to InMax-...-BF actuators!
EXC-DS1/VA	Safety temperature sensor for duct mounting, potential free contact, switching at 70°C...160°C (10°C steps)
MKK-M	Mounting bracket for junction box for actuator size M (details on request)
Junktion Box	Per specification (details on request)
DWB-M	Angle rotation limiter for mounting on actuator size M (details on request)
HV-MK	Manual override, connectable to actuators size M (not suitable for ..Max-...-F3!)
AR-16-xx	Squared reduction part from 0.63" x 0.63" to shafts with 0.55" (type AR-16-14), 0.47" (type AR-16-12)
Valve Linkage Kits	Per valve specification

Special options and offshore kits see page 23

Introducing ExMax + LIN & ExRun – Valve Actuators for Hazardous Locations!

Linear Applications for Valve Control ...



HAZARDOUS LOCATIONS DIV. 1, 2

FAST SPRING RETURN TIME

UNIVERSAL POWER SUPPLY

OFFSHORE/MARINE COATED SOLUTION

EASY INSTALLATION

ROBUST IP66 HOUSING

COMPACT DIMENSIONS

..Max + LIN and ..Run Electrical Drive Engineering for Valves – Overview

Overview ..Max + LIN Linear Guide Unit and ..Run Valve Actuators

Installation Areas:

ExMax.. + LIN, ExRun-for use in hazardous location Div. 1 and zone 1, 2, 21, 22
RedMax.. + LIN, RedRun-for use in hazardous location Div. 2 and zone 2, 22
InMax.. + LIN, InRun-for use in ordinary location

Application Areas:

Ex/Red/InMax + LINfor globe or 3-way valves (with safety function)
Ex/Red/InRunfor globe or 3-way valves

The actuator concept offers obvious advantages:

1. Small dimension, compact, easy installation, highest protection classes, cost effective
2. Universal power supply 24 to 240 Volt AC/DC, selfadjustable
3. SIL2 fail safe function (only at ..Max + LIN)
4. With or without spring return (spring return only at ..Max + LIN linear guide unit)
5. Robust aluminium housing, NEMA4X/IP66
6. Integrated heater for low temperatures
7. On site adjustable motor running time
8. Integrated manual override
9. Useful accessories such as retrofit limit switches

Ibf ExMax.. + LIN

▲ 0.39"
▼ 1.65"

Actuators with Spring Return for 2-Way and 3-Way Valves



ExMax.., RedMax.., InMax.. + LIN Linear Guide Unit

Linear motion valve actuators with spring return from 110 to 670 lbf. Fixed stroke with 0.39"/0.59"/0.79"/1.18"/1.65" for automation of globe or 3-way valves. Linkage to numerous valve types and brands available.

Ibf ExRun..

▲ 0.2"
▼ 2.36"

Actuators for 2-Way and 3-Way Valves



ExRun.., RedRun.., InRun.. Valve Actuators

Valve actuators from 110 to 2,200 lbf. On site adjustable stroke from 0.2" to 2.36", for automation of globe or 3-way valves. Linkage to numerous valve types and brands available.

Ordinary Location

Hazardous Location

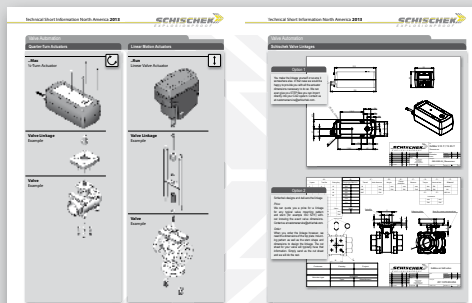

Valve Linkages



Information

Please see pages 48-49 for more information on valve linkages.

..Max-.. + LIN-.. Linear Valve Actuators Size "S" and "M" with Spring Return

Explosion Proof		Industrial	Features ..Max-.. + LIN-.. (Size "S" and "M")	
ExMax-.. + LIN-.. Cl. I/II/III, Div. 1 Zone 1, 2, 21, 22 Gas + Dust certified* according to UL, CSA ATEX, IECEX, EAC, INMETRO, KOSHA ¹ ¹ ExMax size S only *actuator only	RedMax-.. + LIN-.. Cl. I/II/III, Div. 2 Zone 2, 22 Gas + Dust certified* according to UL, CSA ATEX, IECEX, EAC INMETRO *actuator only	InMax-.. + LIN-.. NOT explosion proof and only for use in ordinary locations certified* according to general purpose standard NEMA4X/IP66 *actuator only	Description ..Max-.. + LIN-.. linear valve actuators with spring return for automation of globe- or 3-way valves. Use as actuator with safety function, On-off or 3-pos. actuator or modulating actuator. Scope of Delivery: Linear unit, suitable for all ..Max-..-F actuators size "S" or "M". Required Accessories: Valve adaptation in accordance with valve manufacturer, type and nominal size (diameter). Ordering Example: Modulating valve actuator with spring return in hazardous location zone 2, for a globe valve with 0.79" stroke and a required force of 335 lbf. Actuator: RedMax-30-YF Linear adaptation: LIN-20 Valve adaptation: suitable for valve type on request	Basics for ..Max-.. + LIN-.. valve actuators <ul style="list-style-type: none"> • 24...240 VAC/DC self adaptable power supply • Running time 0.1...15 sec./mm¹ • Stroke 0.30"/0.39"/0.59"/0.79"/1.18"/1.65"¹ • Force 110...670 lbf¹ • Spring return 3 or 10 sec. (size "S"), 20 sec. (size "M")¹ • Control mode On-off, 3-pos., 0-10 VDC, 4-20 mA¹ • Aluminium housing, NEMA4X/IP66² • External terminal box optional² • Ambient temperature -4°F...+104°F (T6), -4°F...+122°F (T5) • Weight (including actuator) ~ 18 lbs (size "S"), ~ 31 lbs (size "M")¹ ¹ in accordance with type ² applies for actuator
				

Linear Unit for Actuators with Spring Return, 24 to 240 VAC/DC

Type	Stroke (max.)	Description
LIN-7.5	0.30"	Linear unit up to max. 0.30" stroke, suitable for all ..Max-..-F actuators size "S" or "M" with spring return
LIN-10	0.39"	Linear unit up to max. 0.39" stroke, suitable for all ..Max-..-F actuators size "S" or "M" with spring return
LIN-15	0.59"	Linear unit up to max. 0.59" stroke, suitable for all ..Max-..-F actuators size "S" or "M" with spring return
LIN-20	0.79"	Linear unit up to max. 0.79" stroke, suitable for all ..Max-..-F actuators size "S" or "M" with spring return
LIN-30	1.18"	Linear unit up to max. 1.18" stroke, suitable for all ..Max-..-F actuators size "S" or "M" with spring return
LIN-40	1.65"	Linear unit up to max. 1.65" stroke, suitable for all ..Max-..-F actuators size "S" or "M" with spring return

LIN Special Options for Linear Unit Suitable for Actuators

Explosion Proof/Ordinary Location		Features LIN-...-CT	
LIN-...-CT available for linear unit LIN-... In accordance with ..Max type for use in Hazardous location or ordinary location	Special Options 	Description CT version with aluminium housing and offshore/marine coating, resistant against corrosive and maritime atmosphere, some parts nickel plated. Delivery: 1 linear unit with special option Ordering Example: LIN-20-CT	Basics LIN-...-CT CT: <ul style="list-style-type: none"> • Offshore/marine coated aluminium housing • Resistant against corrosive and/or maritime atmosphere

LIN-.. Options

Type	Description/Technical Data
LIN-...-CT	Offshore/marine coated aluminium housing, resistant against corrosive and/or maritime atmosphere. Lifting rod, connecting parts and screws in VA

Mounting Variations

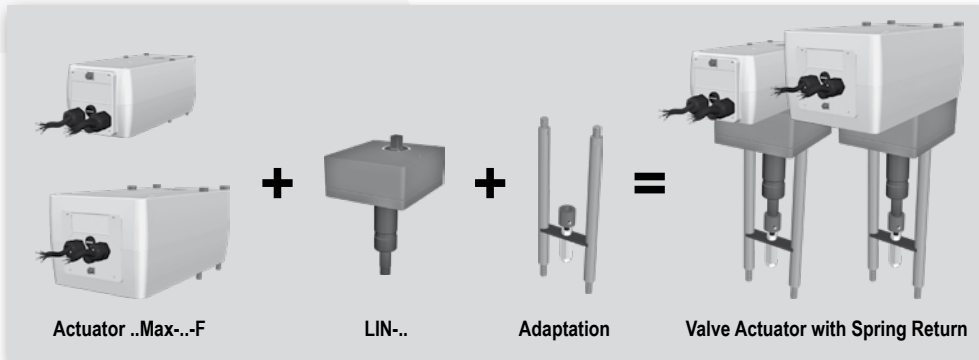

Valve Adaptation

To select the right valve adaptation and get the right price information the following information is required:

1. Valve manufacturer
2. Valve type
3. Valve nominal size (diameter) DN

For adaptations which are already designed by Schischek this information is sufficient.

To design new adaptations we need additional details of the valve body as well as drawings.

With the purchase order you have to provide actuator type + type of adaptation.

Selection of Recommended Actuators in Relation of Force (lbf) and max. Stroke (inch)

Type	LIN - 7.5	LIN - 10	LIN - 15	LIN - 20	LIN - 30	LIN - 40	
max. stroke	0.3" (7,5 mm)	0.39" (10 mm)	0.59" (15 mm)	0.79" (20 mm)	1.18" (30 mm)	1.65" (42 mm)	
Force							At strokes between two values use the next higher linear unit e.g. 0.94" (24 mm) stroke = LIN-30
110 lbf (500 N)				...Max-135-...F	...Max-135-...F	...Max-270-...F	
180 lbf (800 N)	...Max-135-...F	...Max-135-...F	...Max-135-...F		...Max-270-...F	...Max-450-...F	
225 lbf (1,000 N)				...Max-270-...F			
335 lbf (1,500 N)			...Max-270-...F		...Max-450-...F		
450 lbf (2,000 N)						-	
560 lbf (2,500 N)	...Max-270-...F	...Max-270-...F	...Max-450-...F	...Max-450-...F	-	-	
670 lbf (3,000 N)					-	-	

Attention: Limitation of resolution at YF-actuators with strokes < nominal (motor blockade)!
Note the maximum force of the actuator to prevent damage to your valve!

Info: Suitable actuators with spring return see page 10-15.

1

Nominal Force in lbf (N) at Spring of Actuator in Relation of max. Stroke of LIN at Temperatures Between -4...+104 °F

Type	LIN - 7.5	LIN - 10	LIN - 15	LIN - 20	LIN - 30	LIN - 40	
...Max-135-...F	335 lbf (1,500 N)	335 lbf (1,500 N)	225 lbf (1,000 N)	180 lbf (800 N)	110 lbf (500 N)	-	Blocking force in motor is round about 3 to 4 times larger than nominal force. Note valve dimensioning!
...Max-270-...F	670 lbf (3,000 N)	670 lbf (3,000 N)	450 lbf (2,000 N)	335 lbf (1,500 N)	225 lbf (1,000 N)	180 lbf (800 N)	
...Max-450-...F	-	-	670 lbf (3,000 N)	670 lbf (3,000 N)	450 lbf (2,000 N)	335 lbf (1,500 N)	

Attention: Limitation of resolution at YF-actuators with strokes < nominal (motor blockade)!
Note the maximum force of the actuator to prevent damage to your valve!

2

Nominal Force in lbf (N) at Spring of Actuator in Relation of max. Stroke of LIN at Temperatures Between +32...+104 °F

Type	LIN - 7.5	LIN - 10	LIN - 15	LIN - 20	LIN - 30	LIN - 40	
...Max-135-...F	670 lbf (3,000 N)	670 lbf (3,000 N)	450 lbf (2,000 N)	360 lbf (1,600 N)	225 lbf (1,000 N)	-	Blocking force in motor is round about 1.5 to 2 times larger than nominal force. Note valve dimensioning!
...Max-270-...F	1,350 lbf (6,000 N)	1,350 lbf (6,000 N)	900 lbf (4,000 N)	670 lbf (3,000 N)	450 lbf (2,000 N)	360 lbf (1,600 N)	
...Max-450-...F	-	-	1,350 lbf (6,000 N)	1,350 lbf (6,000 N)	900 lbf (4,000 N)	670 lbf (3,000 N)	

Attention: Above mentioned values are nominal trusts with performed self adjustment drive!



The maximum trusts can read values which are up to three to four times higher than values of tables!

Without performed self adjustment drive there can occur much higher trust values, which can cause damages on the mentioned valve or linkages!

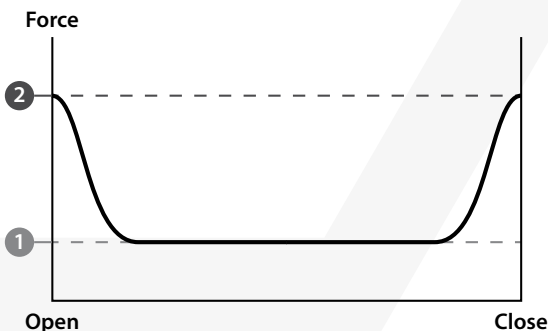
Spring return time depends on the effective required thrust and can exceed standard values!



ExRun/RedRun/InRun Valve Actuators Size "S" for Div. 1/2, Class I/II/III, zone 1, 2, 21, 22

Explosion Proof		Industrial	Features of ExRun, RedRun, InRun	
<p>ExRun...</p> <p>Cl. I/II/III, Div. 1 Zone 1, 2, 21, 22 Gas + Dust certified according to UL, CSA ATEX, IECEx, EAC, INMETRO, KOSHA</p> 	<p>RedRun...</p> <p>Cl. I/II/III, Div. 2 Zone 2, 22 Gas + Dust certified according to UL, CSA ATEX, IECEx, EAC, INMETRO, KOSHA</p> 	<p>InRun...</p> <p>NOT explosion proof and only for use in ordinary locations certified according to general purpose standard NEMA4X/IP66</p> 	<p>Description</p> <p>ExRun, RedRun and InRun valve actuators are used for automation of linear valves with 3-pos. on-off or modulating mode.</p> <p>Scope of Delivery: 1 actuator with NPT1/2" conduit connection and 39.4 inch cable extension, emergency manual override, manuals</p> <p>Required Accessories: valve adaptation in accordance with valve manufacturer, type and nominal size (diameter).</p>	<p>Basics for all ...Run Valve Actuators</p> <ul style="list-style-type: none"> • 24...240 VAC/DC self adaptable power supply • Up to 5 different running times adjustable on site • 0.2" to 2.36" stroke, mechanical limitation on each position • Automatic adaptation of modulating signal at Ex-, Red-, InRun-...-Y.. • Aluminum housing NEMA4X/IP66 • -4°F...+104°F/+122°F, integrated heater • Emergency manual override • Dimension (H¹×W×D) 10.24" × 8.2" × 4.53" (without valve and adaptation) • Approximate weight 16...17 lbs² (without valve and adaptation) <p>¹Height varies depending on type ²Weight varies depending on type</p>

Valve Actuators Without Spring Return, 24 to 240 VAC/DC, for Division 1 and Zone 1, 2, 21, 22

Type	Force	Running Time	Spring Return	Control Mode	Feedback	Stroke	Size
ExRun- 110.220-A	110 / 220 lbf	2/3/6/9 s/0.0394"	-	On-off, 3-pos	-	0.2"...2.36"	S
ExRun- 550.1100-A	550 / 1,100 lbf	2/3/6/9 s/0.0394"	-	On-off, 3-pos	-	0.2"...2.36"	S
ExRun-1650.2200-A	1,650 / 2,200 lbf	4/6/9/12 s/0.0394"	-	On-off, 3-pos	-	0.2"...2.36"	S
ExRun- 110.220-Y-A	110 / 220 lbf	2/3/6/9 s/0.0394"	-	0...10 VDC, 4...20 mA	0...10 VDC, 4...20 mA	0.2"...2.36"	S
ExRun- 550.1100-Y-A	550 / 1,100 lbf	2/3/6/9 s/0.0394"	-	0...10 VDC, 4...20 mA	0...10 VDC, 4...20 mA	0.2"...2.36"	S
ExRun-1650.2200-Y-A	1,650 / 2,200 lbf	4/6/9/12 s/0.0394"	-	0...10 VDC, 4...20 mA	0...10 VDC, 4...20 mA	0.2"...2.36"	S
ExRun- 110.220-U-A	110 / 220 lbf	2/3/6/9 s/0.0394"	-	On-off, 3-pos	0...10 VDC, 4...20 mA	0.2"...2.36"	S
ExRun- 550.1100-U-A	550 / 1,100 lbf	2/3/6/9 s/0.0394"	-	On-off, 3-pos	0...10 VDC, 4...20 mA	0.2"...2.36"	S
ExRun-1650.2200-U-A	1,650 / 2,200 lbf	4/6/9/12 s/0.0394"	-	On-off, 3-pos	0...10 VDC, 4...20 mA	0.2"...2.36"	S

Valve Actuators Without Spring Return, 24 to 240 VAC/DC, for Division 2 and Zone 2, 22

Type	Force	Running Time	Spring Return	Control Mode	Feedback	Stroke	Size
RedRun- 110.220-A	110 / 220 lbf	2/3/6/9 s/0.0394"	-	On-off, 3-pos	-	0.2"...2.36"	S
RedRun- 550.1100-A	550 / 1,100 lbf	2/3/6/9 s/0.0394"	-	On-off, 3-pos	-	0.2"...2.36"	S
RedRun-1650.2200-A	1,650 / 2,200 lbf	4/6/9/12 s/0.0394"	-	On-off, 3-pos	-	0.2"...2.36"	S
RedRun- 110.220-Y-A	110 / 220 lbf	2/3/6/9 s/0.0394"	-	0...10 VDC, 4...20 mA	0...10 VDC, 4...20 mA	0.2"...2.36"	S
RedRun- 550.1100-Y-A	550 / 1,100 lbf	2/3/6/9 s/0.0394"	-	0...10 VDC, 4...20 mA	0...10 VDC, 4...20 mA	0.2"...2.36"	S
RedRun-1650.2200-Y-A	1,650 / 2,200 lbf	4/6/9/12 s/0.0394"	-	0...10 VDC, 4...20 mA	0...10 VDC, 4...20 mA	0.2"...2.36"	S
RedRun- 110.220-U-A	110 / 220 lbf	2/3/6/9 s/0.0394"	-	On-off, 3-pos	0...10 VDC, 4...20 mA	0.2"...2.36"	S
RedRun- 550.1100-U-A	550 / 1,100 lbf	2/3/6/9 s/0.0394"	-	On-off, 3-pos	0...10 VDC, 4...20 mA	0.2"...2.36"	S
RedRun-1650.2200-U-A	1,650 / 2,200 lbf	4/6/9/12 s/0.0394"	-	On-off, 3-pos	0...10 VDC, 4...20 mA	0.2"...2.36"	S

Valve Actuators Without Spring Return, 24 to 240 VAC/DC, for Ordinary Location

Type	Force	Running Time	Spring Return	Control Mode	Feedback	Stroke	Size
InRun- 110.220-A	110 / 220 lbf	2/3/6/9 s/0.0394"	-	On-off, 3-pos	-	0.2"...2.36"	S
InRun- 550.1100-A	550 / 1,100 lbf	2/3/6/9 s/0.0394"	-	On-off, 3-pos	-	0.2"...2.36"	S
InRun-1650.2200-A	1,650 / 2,200 lbf	4/6/9/12 s/0.0394"	-	On-off, 3-pos	-	0.2"...2.36"	S
InRun- 110.220-Y-A	110 / 220 lbf	2/3/6/9 s/0.0394"	-	0...10 VDC, 4...20 mA	0...10 VDC, 4...20 mA	0.2"...2.36"	S
InRun- 550.1100-Y-A	550 / 1,100 lbf	2/3/6/9 s/0.0394"	-	0...10 VDC, 4...20 mA	0...10 VDC, 4...20 mA	0.2"...2.36"	S
InRun-1650.2200-Y-A	1,650 / 2,200 lbf	4/6/9/12 s/0.0394"	-	0...10 VDC, 4...20 mA	0...10 VDC, 4...20 mA	0.2"...2.36"	S
InRun- 110.220-U-A	110 / 220 lbf	2/3/6/9 s/0.0394"	-	On-off, 3-pos	0...10 VDC, 4...20 mA	0.2"...2.36"	S
InRun- 550.1100-U-A	550 / 1,100 lbf	2/3/6/9 s/0.0394"	-	On-off, 3-pos	0...10 VDC, 4...20 mA	0.2"...2.36"	S
InRun-1650.2200-U-A	1,650 / 2,200 lbf	4/6/9/12 s/0.0394"	-	On-off, 3-pos	0...10 VDC, 4...20 mA	0.2"...2.36"	S

Accessories

Type	Description/Technical Data
Stick	Stick to change parameter and factory settings such as running time, torque, spring return time, force control and write protection depending on actuator
HV-R	Manual override with locking mechanism suitable for ..Run valve actuators size S
GMB-1	Rubber bellow up to 2.36", colour black
Adaptation	Different adaptations for different valve types and sizes available. Please don't hesitate to ask for technical solution

Special options and offshore kits see page 23

Required Data for Valve Adaptation

To select the right valve adaptation and get the right price information the following data are required:

1. Valve manufacturer
2. Valve type
3. Valve nominal size (diameter) DN

For adaptations which are already designed by Schischek this information is sufficient.

To design new adaptations we need additional details of the valve body as well as drawings.

With the purchase order you have to provide actuator type and type of adaptation.

...Run + Valve Adaptation

ExRun-...

RedRun-...

InRun-...



Adaption

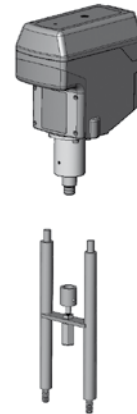

VA/CT Special Options Actuators – Overview

Overview of Special Options of Schischek Actuators for use under Extreme Weather Conditions

Installation/Application Area:

Usage in hazardous locations under extreme weather conditions and/or for offshore/onshore applications.

Advantages of Special Options:

- Resistant against corrosive and/or maritime atmosphere
- Usage under extreme weather conditions
- Approved for offshore-/onshore applications
- Robust and thereby extended period of application time of actuators

Special Options Quarter Turn Actuators Size S

VAS ..Max-.. S
CTS

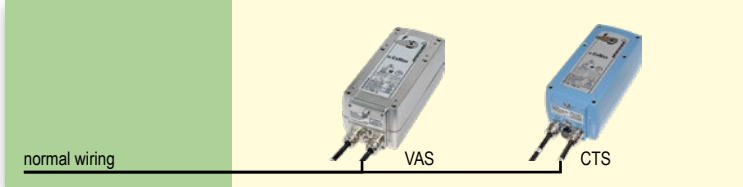

..Max-.. ¼ Turn Actuators Size S

Housing material in stainless steel (VAS) or aluminium housing with offshore/marine coating (CTS) for use under extreme weather conditions.

Special Options Quarter Turn Actuators Size M

VAM ..Max-.. M
CTM

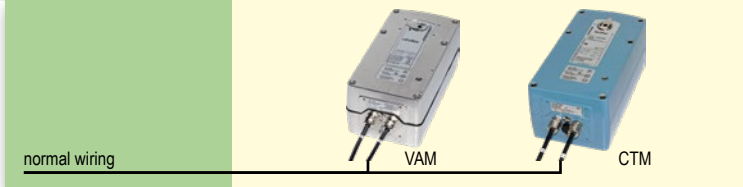

..Max-.. ¼ Turn Actuators Size M

Housing material in stainless steel (VAM) or aluminium housing with offshore/marine coating (CTM) for use under extreme weather conditions.

Special Options Valve Actuators

CTS ..Run-..

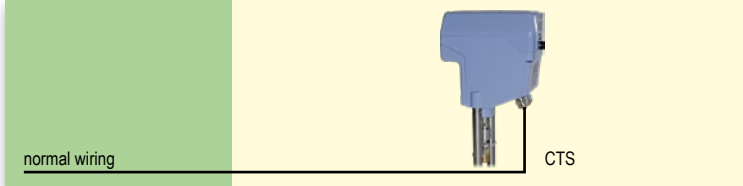

..Run-.. Valve Actuators

Aluminium housing with offshore/marine coating (CTS) for use under extreme weather conditions.

Weather Shield for Quarter Turn and Valve Actuators

WS-S ..Max-.. S/M
WS-M ..Run-..
WS-R

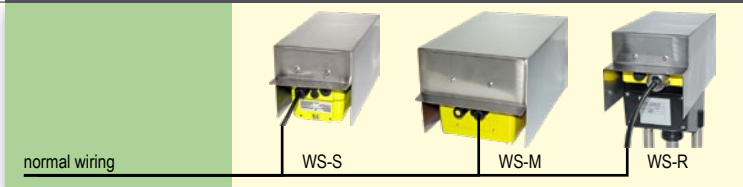

..Max-.. ¼ Turn and ..Run Valve Actuators

Weather shield made of stainless steel for protection against weather influences like rain, sun or snow.

Ordinary Location

Hazardous Location

Further special features on request

- Connection technology and cable fittings
- Special model for temperature range, runtime, corrosion protection, certification, ...
- Special accessories, for e.g. indicators
- Special features, e.g. > 90° angle of rotation or rotary variants

..Max Special Options for Quarter Turn Actuators Size S or M

Explosion Proof

Features ..Max-...VA/CT

..Max-...VA/CT

available for ExMax, RedMax and InMax
In accordance with type for use in Hazardous location or ordinary location

Special Options



Description

VA version with housing material in stainless steel AISI 316, some parts nickel plated.
CT version with aluminium housing and offshore/marine coating, resistant against corrosive and maritime atmosphere, some parts nickel plated.

Delivery: 1 quarter turn actuator size S or M with special option
Ordering Example: ExMax-15.30-VAS

Basics ..Max-...VA/CT

- VA:**
- Housing material in stainless steel AISI 316, some parts nickel plated
- CT:**
- Offshore/marine coated aluminium housing
 - Resistant against corrosive and/or maritime atmosphere
 - Cable glands brass nickel plated
 - Screws in stainless steel
- For general basics see ..Max quarter turn actuators.**

..Max-.. Options

Type	Description/Technical Data
..Max-...-VAS	Housing material of ..Max quarter turn actuator size S in stainless steel AISI 316, some parts nickel plated
..Max-...-VAM	Housing material of ..Max quarter turn actuator size M in stainless steel AISI 316, some parts nickel plated
..Max-...-CTS	Aluminium housing of ..Max quarter turn actuator size S with offshore/marine coating, resistant against corrosive and maritime atmosphere, some parts nickel plated
..Max-...-CTM	Aluminium housing of ..Max quarter turn actuator size M with offshore/marine coating, resistant against corrosive and maritime atmosphere, some parts nickel plated
WS-S	Weather shield in stainless steel, suitable for all ..Max actuators size S
WS-M	Weather shield in stainless steel, suitable for all ..Max actuators size M

..Run Special Options for Valve Actuators

Explosion Proof

Features ..Run-...CTS

..Run-...CTS

available for ExRun, RedRun and InRun
In accordance with type for use in Hazardous location or ordinary location

Special Options



Description

CTS version with aluminium housing and offshore/marine coating, resistant against corrosive and maritime atmosphere, some parts nickel plated.

Delivery: 1 valve actuator with special option
Ordering Example: ExRun-25.50-CTS

Basics ..Run-...CTS

- CTS:**
- Offshore/marine coated aluminium housing
 - Resistant against corrosive and/or maritime atmosphere
 - Cable glands brass nickel plated
 - Screws in stainless steel
- For general basics see ..Run valve actuators.**

..Run-.. Options

Type	Description/Technical Data
..Run-...-CTS	Aluminium housing with offshore/marine coating for ..Run valve actuator, resistant against corrosive/maritime atmosphere, some parts nickel plated
WS-R	Weather shield in stainless steel, suitable for all ..Run valve actuators

ExPolar Heating System – Overview

Overview of New Heating System for Use with Schischek Actuators Down to -58 °F (-50 °C)

Installation/Application Area:

Usage in hazardous locations for temperatures down to -58 °F (-50 °C).

Advantages of ExPolar:

- Especially for usage under high sub-zero temperatures down to -50°C
- Usage directly in hazardous locations (only ExPolar)
- Adaptable on Schischek actuator series type ..Max size S or M

°F ExPolar-..MS



Heating System for Quarter Turn Actuators ExMax Size S

normal wiring

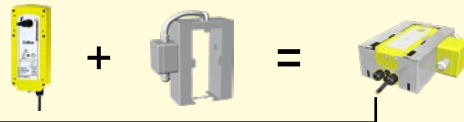

ExPolar-..MS

Adaptable on Schischek quarter turn actuators type ExMax-.. size S.

°F ExPolar-..MM



Heating System for Quarter Turn Actuators ExMax Size M

normal wiring

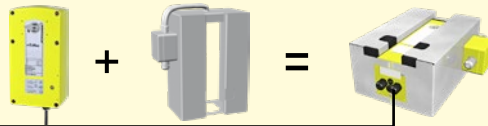



ExPolar-..MM

Adaptable on Schischek quarter turn actuators type ExMax-.. size M.

Ordinary Location

Hazardous Location

ExPolar/InPolar Heating System for ¼ Turn Actuators ..Max-.. Size S

Explosion Proof	Industrial	Features ..Polar-...-MS	
<p>ExPolar-...-MS Zone 1, 2, 21, 22 Gas + Dust certified according ATEX, IECEX, EAC</p> 	<p>InPolar-...-MS NOT explosion proof and only for use in ordinary location IP66</p> 	<p>Description Controlled heating system for use in sub-zero regions down to -58 °F. Adaptable on Schischek quarter turn actuators ..Max-.. size S (depending on type). Delivery: 1 heating system (adaptable) Ordering Example: ExPolar-240-MS</p>	<p>Basics ..Polar</p> <ul style="list-style-type: none"> • 24/48 VAC/DC, 120/240 VAC • 60 W • -58...+140 °F (-50...+60 °C) • ExPolar for zone 1, 2, 21, 22 • InPolar for ordinary location

ExPolar-...-MS/InPolar-...-MS



Type	Adaptable on	Operation Temperature	Supply				Power*	Installation Area
ExPolar-...-MS	ExMax-../RedMax size S	-58 °F up to +140 °F	24 VAC/DC	48 VAC/DC	120 VAC	240 VAC	60 W	zone 1, 2, 21, 22
InPolar-...-MS	InMax-.. size S	-58 °F up to +140 °F	24 VAC/DC	48 VAC/DC	120 VAC	240 VAC	60 W	ordinary location

↑ Supply voltage

*Nominal value

Not suitable for VA versions!

ExPolar/InPolar Heating System for ¼ Turn Actuators ..Max-.. size M

Explosion Proof	Industrial	Features ..Polar-...-MM	
<p>ExPolar-...-MM Zone 1, 2, 21, 22 Gas + Dust certified according ATEX, IECEX, EAC</p> 	<p>InPolar-...-MM NOT explosion proof and only for use in ordinary location IP66</p> 	<p>Description Controlled heating system for use in sub-zero regions down to -58 °F. Adaptable on Schischek quarter turn actuators ..Max-.. size M (depending on type). Delivery: 1 heating system (adaptable) Ordering Example: ExPolar-240-MM</p>	<p>Basics ..Polar</p> <ul style="list-style-type: none"> • 24/48 VAC/DC, 120/240 VAC • 60 W • -58...+140 °F (-50...+60 °C) • ExPolar for zone 1, 2, 21, 22 • InPolar for ordinary location

ExPolar-...-MM/InPolar-...-MM

Type	Adaptable on	Operation Temperature	Supply				Power*	Installation Area
ExPolar-...-MM	ExMax-../RedMax size M	-58 °F up to +140 °F	24 VAC/DC	48 VAC/DC	120 VAC	240 VAC	60 W	zone 1, 2, 21, 22
InPolar-...-MM	InMax-.. size M	-58 °F up to +140 °F	24 VAC/DC	48 VAC/DC	120 VAC	240 VAC	60 W	ordinary location

↑ Supply voltage

*Nominal value

Not suitable for VA versions!

Special option

Type	Description/Technical data
...Polar-...-CT	Housing offshore/marine coated, resistant against corrosive/maritime atmosphere, some parts nickel plated (surcharge)

Introducing ExReg – HVAC Control Unit for Hazardous Locations!

Control Applications for VAV/CAV, Pressure, Temperature and Humidity ...



HAZARDOUS LOCATIONS ZONE 1, 2, 21, 22

DECENTRALISED CONTROL STRUCTURES

REDUCED LIFE-CYCLE-COSTS

NO INTRINSIC SAFE CIRCUITS NEEDED

INTEGRAL PID LOOP

COMPATIBILITY TO MARKET STANDARDS

PREDEFINED SETTINGS

PREDEFINED DAMPER CHARACTERISTICS

ExReg../RedReg../InReg.. Control Systems – Overview

Overview of the New ExReg.., RedReg.. and InReg.. Control Systems Solution

Installation areas:

- ExReg-..... Modules for hazardous location zone 1, 2, 21, 22 (ATEX)
- RedReg-..... Modules for hazardous location Cl. I, Div. 2, zone 2 (ATEX)
- InReg-..... Modules for ordinary location

Application areas:

- ExReg/RedReg/InReg-V Modules for volume flow control (CAV/VAV)
- ExReg/RedReg/InReg-V Modules for pressure and differential pressure control
- ExReg/RedReg/InReg-D Modules for temperature control
- ExReg/RedReg/InReg-D Modules for humidity control

The New Control Systems Concept Offers Especially in Hazardous Location Huge Benefits:

1. Usage directly in hazardous locations in zone 1, 2, 21, 22
2. Can be configured on site in the hazardous location
3. Decentralised control structures
4. Fewer components
5. Reduced Life-Cycle-Costs
6. No necessity to install safety barriers or to use special wiring
7. Integral PID loop
8. Optional in stainless steel (AISI 316) or with offshore/marine coating
9. Predefined Settings and damper characteristics
10. Cost effective

VAV
ΔP

ExReg-V



Volume Flow (CAV/VAV) / Pressure ΔP

normal wiring

ExReg-V.., RedReg-V.., InReg-V..

Control of air flows and pressure in ventilation systems for building management control equipment, for chemical, pharmaceutical, industrial and offshore plants directly in hazardous location zones 1, 2 (gas) and 21, 22 (dust), (InReg-V.. in ordinary location). To complete the technical solution on a ventilation damper (with orifice plate and known shield/k-factor) an additional actuator type ExMax...-CY or ExMax...-CYF (with fail safe spring return) is required.

°F

ExReg-D



Temperature °F (°C)

normal wiring

ExReg-D.., RedReg-D.., InReg-D..

Control of temperature in ventilation systems for building management control equipment, for chemical, pharmaceutical, industrial and offshore plants directly in hazardous location zones 1, 2 (gas) and 21, 22 (dust), (InReg-D.. in ordinary location). To complete the technical solution an additional valve actuator type ExMax...-CY, ExMax...-CYF (with fail safe spring return) or ExRun... is required.

%rH

ExReg-D



Humidity %rH

normal wiring

ExReg-D.., RedReg-D.., InReg-D..

Control of humidity in ventilation systems for building management control equipment, for chemical, pharmaceutical, industrial and offshore plants directly in hazardous location zones 1, 2 (gas) and 21, 22 (dust), (InReg-D.. in ordinary location). To complete the technical solution an additional valve actuator type ExMax...-CY, ExMax...-CYF (with fail safe spring return) or ExRun... is required.

Ordinary Location Hazardous Location

ExCos../RedCos../InCos.. Sensors with Analog Output – Overview

Overview of ExCos..., RedCos and InCos Sensor Technology

Installation areas:

ExCos-sensors for hazardous locations zone 1, 2, 21, 22 (ATEX)
RedCos-sensors for hazardous locations Cl. I, Div. 2, Gr. ABCD/zone 2
InCos-sensors for ordinary locations (NEMA4X/IP66)

Application areas:

Ex/Red/InCos-Psensors for pressure and differential pressure
Ex/Red/InCos-D + ..Pro-C.....active sensors for temperature and/or humidity

The Sensor Concept Offers Especially in Hazardous Locations Huge Benefits:

1. No intrinsically safe wiring required between the control panel and the sensor
2. No intrinsically safe circuit necessary inside the control panel
3. No transmitter needed in the electrical control panel
4. Reduced installation cost
5. Easy installation
6. Easy parameterisation
7. Cost savings for electrical components
8. Actual value indication
9. Optional in stainless steel (AISI 316) or with offshore/marine coating

Pressure, Differential Pressure, VAV – Analog, Active

Δ P ExCos-P



normal wiring



ExCos-P., RedCos-P., InCos-P.. Sensors

Transmitter with integrated differential-pressure sensor for direct connection of the air-hoses. NEMA4X/IP66 housing with integrated terminal-box. Measuring range parametrizable on site. Outputs 0...10V VDC/4...20 mA. Integrated actual value indication, illuminated.

Temperature and/or Humidity – Analog, Active

**°F
%rH ExCos-D
+ ExPro-C..**



normal wiring

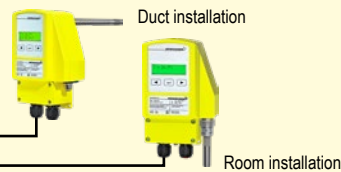

**ExCos-D., RedCos-D., InCos-D..
Transmitter + ExPro-C., InPro-C.. Sensor**

Transmitter for the installation of an ExPro-C.. or InPro-C.. (with InCos-D) for temperature C° and/or humidity in %. NEMA4X/IP66 housing with integrated terminal-box. Measuring-range parametrizable on site. Outputs 0...10V VDC/4...20 mA. Integrated actual value indication, illuminated.

ExBin../RedBin../InBin.. Sensors with Switching Output (Relay) – Overview

Overview of ExBin..., RedBin... and InBin... Sensor Technology

Installation areas:

ExBin-Sensors for hazardous location zone 1, 2, 21, 22 (ATEX)
RedBin-Sensors for hazardous location Cl. I, Div. 2, Gr. ABCD /zone 2
InBin-Sensors for ordinary location (IP66)

Application areas:

Ex/Red/InBin-Psensors for pressure and differential pressure monitoring
Ex/Red/InBin-FRsensors for frost protection monitoring
Ex/Red/InBin-D + ..Pro-B.....active probe sensors for temperature and/or humidity monitoring
Ex/Red/InBin-A + ..Sens..... passive probe sensors for temperature, humidity, pressure monitoring

The Binary Sensor Concept Offers Especially in Hazardous Locations Huge Benefits:

1. No intrinsically safe wiring required between the control panel and the sensor
2. No intrinsically safe circuit necessary inside the control panel
3. No switching module needed in the electrical control panel
4. Reduced installation cost
5. Easy installation
6. Easy parameterisation
7. 1- and 2-stage versions available
8. Actual value indication
9. Optional in stainless steel (AISI 316) or with offshore/marine coating

Differential Pressure Switch ExBin-P-100



Ideal for purge and pressurization systems

Highlights

- Differential pressure range adjustable between 0 to 0.08 and 0 to 0.4 inch water
- Adjustable time delay on "door open alarm" (can also be de-activated)
- Applications with a smaller differential pressure range

Pressure, Differential Pressure (Filter/Fan Belt Monitoring) – Active

Δ P ExBin-P



normal wiring



ExBin-P..., RedBin-P..., InBin-P..

Binary pressure/differential pressure auxiliary switch 0...500 or 0...5.000 Pa, for direct connection of air hoses. IP66 Aluminium die-casting housing with integrated terminal box. Set points adjustable on site, output 1 potential-free make contact. Integrated indication of actual value, illuminated. 2-stage version optionally available.

Frost Protection Thermostats – Active

°F ExBin-FR



normal wiring



ExBin-FR..., RedBin-FR..., InBin-FR..

Frost protection thermostat mechanically adjustable and switching. Setting range 14...59 °F. 118" or 236" (3 or 6 m) capillary as sensor with a resolution of 15.75" (40 cm) effective range. Switching status display with LED. IP66 Aluminium die-cast housing with integrated terminal box. Output 1 potential-free make contact.

Thermostats, Hygrostats – Active

°F ExBin-D + ExPro-B..
%rH



normal wiring



ExBin-D..., RedBin-D..., InBin-D.. + ExPro-B.. Respectively InPro-B... Sensors

Thermostats and/or hygrostats for connection of one ExPro-B.. respectively InPro-B.. sensor. Operating range adjustable. Indication of actual value. IP66 Aluminium die-cast housing with integrated terminal box. Output 1 potential-free make contact. 2-stage version optionally available.

1- or 2-Channel Switching Module for Passive Sensors

°C ExBin-A + ExSens
%rH
ΔP



normal wiring



ExBin-A1/A2, RedBin-A1/A2 + ExSens Switching Sensors

1- or 2-channel Ex-switching module for connection of max. 2 passive, potential-free switching sensors. Switching status display with LED. IP66 Aluminium die-cast housing with integrated terminal box. Output depending on type 1-2 make contacts with collective supply unit.

Ordinary Location

Hazardous Location

..VA/..CT Special Options for Sensors – Overview

Overview of Special Options of Schischek Sensors for Use under Extreme Weather Conditions

Installation/Application Area:

Usage in hazardous locations under extreme weather conditions and/or for offshore/onshore applications.

Advantages of Special Options:

- Resistant against corrosive and/or maritime atmosphere
- Usage under extreme weather conditions
- Approved for offshore-/onshore applications
- Robust and thereby extended period of application time of sensors

VA
OVA
CT
OCT

Special Options Sensors

normal wiring



VA/OVA



CT/OCT

Ordinary Location

Hazardous Location

Sensors

Housing material in stainless steel (VA) or aluminium housing with offshore/marine coating (CT) for use under extreme weather conditions. OVA and OCT version for offshore applications.

..Cos/..Bin/..Reg Special Options for Sensors

Explosion Proof

Features ..Cos/..Bin/..Reg-...-VA/OVA/CT/OCT

Cos/Bin/Reg-...-VA/CT	Special Options	Description	Basics ..Cos/..Bin/..Reg-...-VA/OVA/CT/OCT
<p>available for all sensors In accordance with type for use in Hazardous location or ordinary location</p>		<p>VA version with housing material in stainless steel AISI 316, some parts nickel plated. OVA version also with stainless steel housing but suitable especially for offshore applications. CT version with aluminium housing and offshore/marine coating, resistant against corrosive and maritime atmosphere, some parts nickel plated. OCT version with painted housing like CT, but suitable especially for offshore applications.</p> <p>Delivery: 1 sensor with special option Ordering Example: ExCos-P-250-CT</p>	<p>VA:</p> <ul style="list-style-type: none"> • Housing material in stainless steel AISI 316, some parts nickel plated • Resistant against corrosive/maritime atmosphere <p>OVA:</p> <ul style="list-style-type: none"> • Basics like VA, but offered as offshore version with M20 cable glands and additionally with tubes for clamping ring Ø 0.24" (6 mm) in stainless steel <p>CT:</p> <ul style="list-style-type: none"> • Offshore/marine coated aluminium housing • Resistant against corrosive/maritime atmosphere • Cable glands brass nickel plated • Screws in stainless steel <p>OCT:</p> <ul style="list-style-type: none"> • Basics like CT, but offered as offshore version with M20 cable glands and additionally with tubes for clamping ring Ø 0.24" (6 mm) in stainless steel <p>For general basics see sensor technology.</p>

..Cos/..Bin/..Reg-.. Options

Type	Description/Technical Data
Cos/Bin/Reg-.. VA	Housing material in stainless steel AISI 316, some parts nickel plated
Cos-P/Bin-P/Reg-V..-OVA	Offshore version with seawater resistant stainless steel housing. M20 cable glands nickel-plated, pressure connection tubes and screws in stainless steel
Cos/Bin/Reg-.. CT	Offshore/marine coated aluminium housing, resistant against corrosive and/or maritime atmosphere. Cable glands nickel-plated, screws in stainless steel
Cos-P/Bin-P/Reg-V..-OCT	Offshore version with seawater resistant offshore/marine coated alu housing. M20 cable glands nickel-plated, pressure connection tubes and screws in stainless steel
Kit-S8-CBR	Cable glands 2 × M16 × 1,5 mm standard 0.2"-0.39" (5-10 mm) in brass nickel plated for replace the plastic cable glands of ..Cos/..Bin/..Reg sensors
Kit-Offs-GL-CBR	M20 Ex-d cable glands in brass nickel plated for armoured cables suitable for ..Cos/..Bin/..Reg sensors
Kit-PTC-CBR	Pressure tube connection in stainless steel 316 L for 0.24" (6 mm) clamp fittings

ExPolar Heating System – Overview

Overview of New Heating System for Use with Schischek Sensors Down to -40 °F (-40 °C)

Installation/Application Area:

Usage in hazardous locations for temperatures down to -40 °F (-40 °C).

Advantages of ExPolar:

- Especially for usage under high sub-zero temperatures (down to -40 °F)
- Usage directly in hazardous locations
- Adaptable on all Schischek sensors

°F ExPolar...-CBR

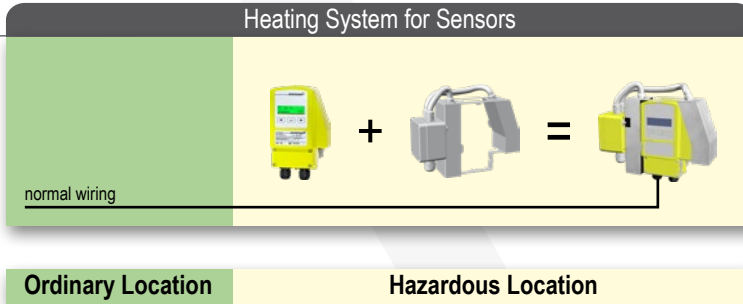

ExPolar...-CBR

Adaptable on Schischek sensors type ExCos..., ExBin..., ExReg...

ExPolar/InPolar Heating System for ..Cos../Bin../Reg.. Sensors

Explosion Proof

ExPolar...-CBR

Zone 1, 2, 21, 22
Gas + Dust
certified according to
ATEX, IECEx



Industrial

InPolar...-CBR

NOT explosion proof
and only for use in
ordinary locations
IP66



Features ..Polar...-CBR

Description

Controlled heating system for use in sub-zero regions down to -40 °F.
Adaptable on Schischek sensors ..Cos..., ..Bin... or ..Reg-...

Delivery: 1 heating system (adaptable)

Ordering Example: ExPolar-240-CBR

Basics ..Polar

- 24/48 VAC/DC, 120/240 VAC
- 60 W
- -40 °F...140 °F (-40 °C...+60 °C)
- ExPolar for zone 1, 2, 21, 22
- InPolar for ordinary location

ExPolar...-CBR/InPolar...-CBR

Type	Adaptable on	Operation Temperature	Supply				Power*	Installation Area
ExPolar...-CBR	ExCos.../ExBin.../ExReg..	-40 °F up to +140 °F	24 VAC/DC	48 VAC/DC	120 VAC	240 VAC	60 W	zone 1, 2, 21, 22
InPolar...-CBR	InCos.../InBin.../InReg..	-40 °F up to +140 °F	24 VAC/DC	48 VAC/DC	120 VAC	240 VAC	60 W	ordinary location

↑ Supply voltage

*Nominal value

Not suitable for VA versions!

ExMag Electric Door Holder Magnets for Zone 1, 2, 21, 22 (ATEX)

Explosion Proof		Features ExMag (EXM)	
ExMag	Magnet	Description	Basics ExMag (EXM)
Zone 1, 2, 21, 22 Gas + Dust certified according to ATEX, IECEx, DNV-GL		<p>ExMag door holder magnets are electric magnets to keep doors open or closed as long as supply voltage is available.</p> <p>Scope of Delivery: 1 magnet + accessories</p> <p>Ordering Example: 650 N magnet + anchor + Ex-terminal box</p> <p>Type to Purchase: 1 × EXM-650 + 1 GH 6 + 1 × EXC-K4/S</p>	<ul style="list-style-type: none"> • Electric magnets, silicone free • Force in acc. with type • 24 VDC power supply • 1 m cable, silicone and halogen free • Ex-e terminal box is required for electrical connection • The max. AC-ripple must not exceed 20%

Ex-m ExMag Magnets

Type	Force	Supply	Function	Current	Installation Area
EXM-650	146 lbf (650 N)	24 VDC	Magnet	44 mA	Zone 1, 2, 21, 22
EXM-1300	292 lbf (1.300 N)	24 VDC	Magnet	65 mA	Zone 1, 2, 21, 22
EXM-2000	450 lbf (2.000 N)	24 VDC	Magnet	160 mA	Zone 1, 2, 21, 22

Accessories

Type	Description/Technical Data
GH-6	Anchor for EXM-650
GH-13/20	Anchor for EXM-1300 and EXM-2000
ExBox-3P	Ex-e terminal box, IP66
EXC-K4/S	Ex-e terminal box with integrated fuse, IP66
EXC-T1	Ex-d push button
N1 supply unit	Input 120...240 VAC, output 24 VDC, max. 0,5 A

Ex applications

Air safety dampers • Air control dampers • Fire/smoke dampers

Air damper control

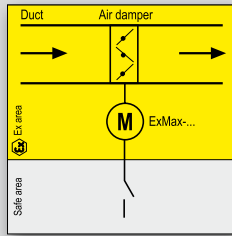

Schischek actuators are approved for direct installation and operation in explosive atmospheres, as they are of the highest explosion groups and temperature class and are suitable for all gases, mists, vapors and dust. During installation please ensure that all cables are securely fixed and connected in such a way that they are protected from mechanical damage. For electrical connection an explosion protected terminal box (type ExBox-...) has to be used.

Automatic air damper control

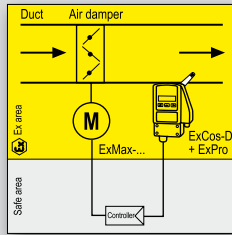

In this example the control system consists of an actuator and an ExCos-D transmitter with ExPro sensor. The combination can be installed directly in an Ex area. The transmitter converts the sensor signal into an active signal (0...10 VDC or 4...20 mA) for input in a PLC system. The output signal from the controller goes directly to the actuator. Between sensor and controller an additional Ex-i module and intrinsically safe (IS) circuit wiring are not required. For the actuator and transmitter the maximum permissible surface temperatures have to be taken into account.

Control of fire/smoke dampers

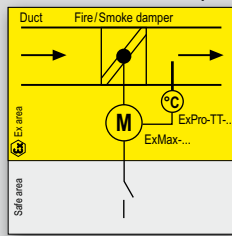

In applications for fire/smoke dampers, the actuator has to reliably return the damper to its safety position via an external switch/contact. The actuator closes the damper mechanically by means of an internal spring. The closing operation is triggered by a safety thermal trigger of type ExPro-TT-...

Heating • Cooling • Humidification • Diff.pressure control • VAV

Heating/cooling control

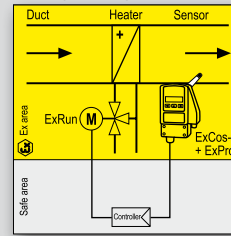

In this example the control system consists of an actuator and an ExCos-D transmitter with ExPro sensor. The combination can be installed directly into an Ex area. The transmitter converts the sensor signal into an active signal (0...10 VDC or 4...20 mA) for input in a PLC system. The output signal from the controller goes directly to the actuator. Between sensor and controller an additional Ex-i module and intrinsically safe (IS) circuit wiring are not required. For the actuator and transmitter the maximum permissible surface temperatures have to be taken into account.

Humidity control

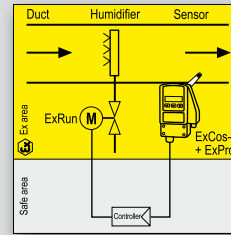

In this example the control system consists of a valve actuator and an ExCos-D transmitter with ExPro sensor. The combination can be installed directly into an Ex area. The transmitter converts the sensor signal into an active signal (0...10 VDC or 4...20 mA) for input in a PLC system. The output signal from the controller goes directly to the actuator. Between sensor and controller an additional Ex-i module and intrinsically safe (IS) circuit wiring are not required. For the actuator and transmitter the maximum permissible surface temperatures have to be taken into account.

Differential pressure control/VAV

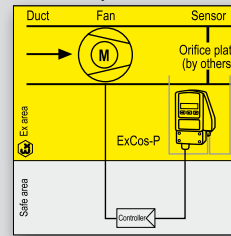

In this example the control system consists of an actuator and a differential pressure ExCos-P transmitter. The combination can be installed directly in an Ex area. The transmitter converts the differential pressure signal into an active signal (0...10 VDC or 4...20 mA) for input in a PLC system. The output signal from the controller goes directly to the actuator. Between sensor and controller an additional Ex-i module and intrinsically safe (IS) circuit wiring are not required. The controller is located in the safe area and delivers an output signal for example via a frequency converter to control a fan (must be Ex protected) or a modulating damper actuator (also Ex protected) to maintain the required air volume/pressure. The technical specifications can be found in the approval documents.

Thermostats • Humidistats • Pressostats • Filter monitoring

Thermostats

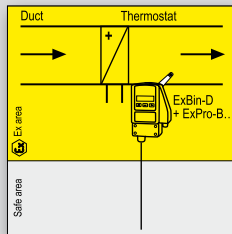

ExBin-D... modules with ExPro-BT... sensor are thermostats for use in potentially explosive atmospheres. No intrinsically-safe electrical circuits and no switching amplifiers need to be installed in the electrical control-panel. The module may be installed directly in an Ex area, depending on demand in zone 1, 2, 21 or 22. The output contact can be used for follow-up functions (relays, contacts, direct circuit, ...).

Hygrostats

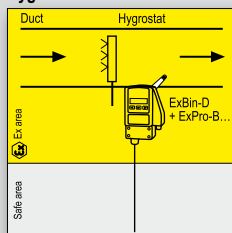

ExBin-D... modules with ExPro-BF... sensor are hygrostats for use in potentially explosive atmospheres. No intrinsically-safe electrical circuits and no switching amplifiers need to be installed in the electrical control-panel. The module may be installed directly in an Ex area, depending on demand in zone 1, 2, 21 or 22. The output contact can be used for follow-up functions (relays, contacts, direct circuit, ...).

Filter monitoring

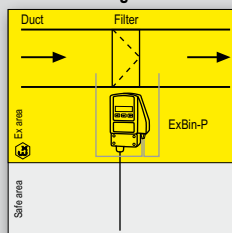

ExBin-P... modules are pressostats like Ex-differential pressure switches, e.g. for filter monitoring in potentially explosive atmospheres. No intrinsically-safe electrical circuits and no switching amplifiers need to be installed in the electrical control-panel. The module may be installed directly in an Ex area, depending on demand in zone 1, 2, 21 or 22. The output contact can be used for follow-up functions (relays, contacts, direct circuit, ...).

Drive (Fan) belt monitoring • Frost protection

Drive (Fan) belt monitoring with differential pressure sensor/air paddle

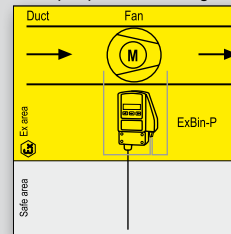

ExBin-P... modules are pressostats like Ex-differential pressure switches, e.g. for fan belt monitoring in potentially explosive atmospheres. No intrinsically-safe electrical circuits and no switching amplifiers need to be installed in the electrical control-panel. The module may be installed directly in an Ex area, depending on demand in zone 1, 2, 21 or 22. To indicate fan failure switching modules are delivered with integrated time running relay with delay on start up. The output contact can be used for follow-up functions (relays, contacts, direct circuit, ...).

Frost protection

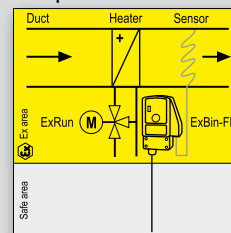

ExBin-FR... are sensors for frost protection monitoring with a capillary as measuring element for use in potentially explosive atmospheres. No intrinsically-safe electrical circuits and no switching amplifiers need to be installed in the electrical control-panel. The module may be installed directly in an Ex area, depending on demand in zone 1, 2, 21 or 22. The output contact can be used for follow-up functions (relays, contacts, direct circuit, ...).

Fan belt monitoring via Namur sensor

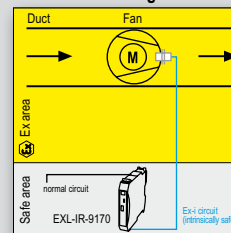

EXL-IR-9170 switching modules in combination with connected Namur sensor (inductive proximity switch) are suitable for non-contact V-belt monitoring of fans in hazardous locations. The switching module is installed in the safe area. Wiring is via an intrinsically safe Ex-i circuit. The proximity switch type Namur is installed in the hazardous location, depending on the sensor type and certification in zone 1 or 2. The input of the switching module is a passive, potential-free, binary signal, the output is a potential-free, switching contact.

Product Codes/Definitions

Description ..Max Quarter Turn Actuators

Ex Max - 45.90 - SF - A

A = America, for installation in the USA or Canada (UL and CSA certified)

S = integral auxiliary **switches** at 5 and 85 degrees

F = spring return, the German word for **spring** is "Feder", that's why

Y = **modulating**, i.e. 0...10 VDC or 4...20 mA input and feedback signal

BF = **fire damper actuators** which work with and require the ExPro-TT fire trigger, a great solution for fire dampers, see page 38 for more information

F1 or F3 = actuators with a fast 1 or 3 second spring return – these are then **single acting** whereas our actuators generally speaking are all **double acting** even if they have a spring

The number tells you the **torque** in units of in-lbs (inch pounds)

Two numbers mean that you can switch (on site) between the two, see programming stick on page 38

Max is a **rotary** (quarter turn) actuator for dampers or for rotary valves, such as ball or butterfly valves

Ex is for use in **Div 1** or Zone 1, see page 41 for an explanation of the hazardous location classification system

Red is for use in **Div 2** or Zone 2

In is for use in **non-classified** areas



Description ..Run Valve Actuators

Red Run - 550.1100 - U - A

A = America, for installation in the USA or Canada (UL and CSA certified)

Y = **modulating**, i.e. 0...10 VDC or 4...20 mA input and feedback signal

U = **floating control** with 0...10 VDC, 4...20 mA feedback signal; no modulating input; for modulating input select Y

The number tells you the **force** in units of lbf (pound force)

Two numbers mean that you can switch (on site) between the two, see programming stick on page 38

Run is a **linear** actuator for globe style control valves with a stroke from 5 mm (0.2") up to 60 mm (2.36")

Ex is for use in **Div 1** or Zone 1, see page 41 for an explanation of the hazardous location classification system

Red is for use in **Div 2** or Zone 2

In is for use in **non-classified** areas



Description ..Cos Analog Transmitter

In Cos - P - 2500

The number shows the measuring range of the differential pressure sensor in \pm Pa

P = **differential pressure** sensor

D = module for **temperature/humidity** for connection of ExPro-C.. sensors

A = transmitter modul for connection of **passive** sensors

Cos analog transmitter with output 0...10 V or 4...20 mA

Ex is for use in **zone 1, 2, 21, 22** (ATEX, etc.)

Red is for use in **Div 2** or Zone 2 (CSA, ATEX, etc.)

In is for use in **non-classified** areas



Product Codes/Definitions

Description ..Bin Binary Sensors

Red Bin - P - 500 - 2

The number stands for **2-stage adjustable switch-point** in measurement range
Without number the sensor is 1-stage adjustable switch-point in measurement range

The number shows the max. adjustment range of the differential pressure switch in **Pa**

- P** = differential pressure switch
- D** = thermostat-/hygrostat modul for connection of ExPro-B.. sensors
- FR** = frost protection thermostat
- N** = fan belt monitoring via speed control
- A1** = switching module for connection of **one passive switch**
- A2** = switching module for connection of **two passive switches**
- A5** = switching module for connection of **five passive switches**

Bin switching measuring module with output as a potential free contact 1O oder 1C

Ex is for use in zone 1, 2, 21, 22 (ATEX, etc.)
Red is for use in Div 2 or Zone 2 (CSA, ATEX, etc.)
In is for use in non-classified areas



Description ..Pro.. Sensors for ..Cos-D or ..Bin-D Modules

Ex Pro - CTF - 200

The number shows the **length** of the sensor in **mm**

- T** = temperature sensor
- F** = humidity sensor
- TF** = combisensor temperature/humidity
- C** = sensor for connection to Ex/Red/InCos-D
- B** = sensor for connection to Ex/Red/InBin-D

Pro.. sensor for connection

Ex is for use in zone 1, 2, 21, 22
In is for use in non-classified areas

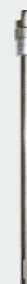

Description ..Reg Controller

Red Reg - V - 300 - A

- A** = Type with **analog** signals for external communication
- B** = Type with **bus** communication (RS485)

The number shows the control range of the controller in **Pa** (V-type only)

- V** = volume flow control/pressure control
- D** = temperature/humidity control

Reg controller

Ex is for use in zone 1, 2, 21, 22 (ATEX, etc.)
Red is for use in Div 2 or Zone 2 (CSA, ATEX, etc.)
In is for use in non-classified areas



Installation According to NEC 500 (Division System)

Installation FM/CSA Hazardous Locations Classes and Divisions

ARTICLES 500 Through 516 (NEC): Explain in detail the requirements for the installation of wiring of electrical equipment in hazardous locations. These articles along with other applicable regulations, local governing inspection authorities, insurance representatives, and qualified engineering/technical assistance should be your guides to the installation of wiring or electrical equipment in any hazardous or potentially hazardous location.

CLASS I (NEC 500.5, 501): Those areas in which flammable gases or vapors may be present in the air in sufficient quantities to be explosive or ignitable.

CLASS II (NEC 500.5, 502): Those areas made hazardous by the presence of combustible dust.

CLASS III (NEC 500.5, 503): Those areas in which there are easily ignitable fibers or flyings present, due to type of material being handled, stored, or processed.

DIVISION 1 (NEC 500.5, 501, 502, 503): In Division 1 the hazard would be present in everyday production or frequent repair and maintenance activity.

DIVISION 2 (NEC 500.5, 501, 502, 503): In Division 2 the hazard is expected to be

confined within closed containers or systems and would be present only through accidental rupture, breakage, or unusual faulty operation.

GROUPS (NEC 500.6): The gases or vapors of Class I locations are broken into four groups by code: A, B, C, and D. These materials are grouped according to the ignition temperature of the substance, the explosion pressure and other flammable characteristics. (article 501) Group A: Acetylene; B: Hydrogen, etc.; C: Ether, etc.; D: Hydrocarbons, fuels, solvents, etc. Class II dust locations are broken into three groups by code: E, F, and G. These groups are classified according to the ignition temperature and the conductivity of the hazardous substance. Dusts (NEC 500.6) E: Metal dusts (conductive, and explosive); F: Carbon dusts (some are conductive, and all are explosive); G: Flour, starch, grain, combustible plastic or chemical dust. Class III locations include those where fibers or flyings are present such as may be found in textile plants, wood-working plants, etc.

SEALS (NEC 501.15, 502.15, 504.70, 505.16, 506.16): Special fittings that are required either to prevent the passage of hot gasses in the case of an explosion in a Class I area or the passage of combustible dust, fibers, or flyings in a Class II or III area.

Installation FM/CSA Div. Classes

Ordinary Location



Hazardous Location

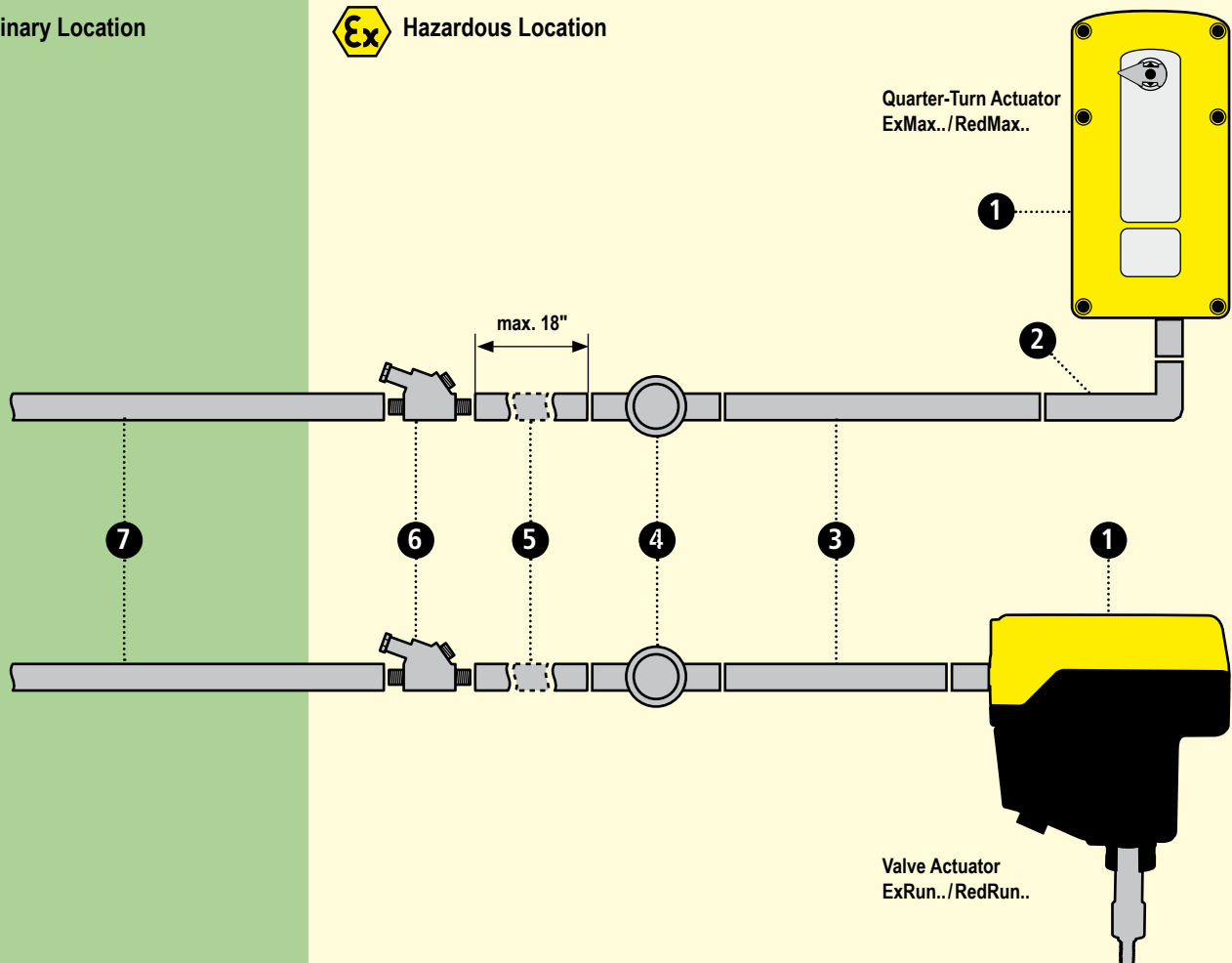

- 1 Explosion proof actuator (ExMax/RedMax, ExRun/RedRun)
- 2 Elbow device...
- 3 Connecting device...
- 4 Conduit box...

- 5 Connecting device, max. length 18"
- 6 Seal fitting for horizontal or vertical conduits...
- 7 Connecting device reaches into the ordinary location...

Installation According to NEC 505 and 506 (Zone System)

Installation FM/CSA Hazardous Locations Classes and Zones

ARTICLES 505 and 506: The Zone classification concept was introduced in the 1996 and extended in the 2005 editions of the NEC as an alternative to the Division classification system for classifying Class I and Class II hazardous locations. The Zone concept parallels the Division system, as is shown in the table on the right. As the table shows, a Division 2 location can be classified as Zone 2 and 22 without further thought; they are considered equivalent. However, a Division 1 location must be further characterized to determine whether it is Zone 0 or Zone 1, 20 or 21.

Class I, Zone 0 and Class II, Zone 20 means the ignitable atmosphere is always present or is present most of the time.

Class I, Zone 1 and Class II, Zone 21 is essentially the same as Class I, Division 1 and Class II, Division 1.

Class I, Zone 2 and Class II, Zone 22 is essentially the same as Class I, Division 2 and Class II, Division 2, meaning the ignitable atmosphere is seldom present or only for a short period of time.

	Ignitable atmosphere present continuously or for long periods of time	Ignitable atmosphere present intermittently during normal operations	Ignitable atmosphere present only during abnormal operations
NEC 500	Division 1	Division 1	Division 2
NEC 505	Zone 0	Zone 1	Zone 2
NEC 506	Zone 20	Zone 21	Zone 22

Installation Zones

Ordinary Location



Hazardous Location

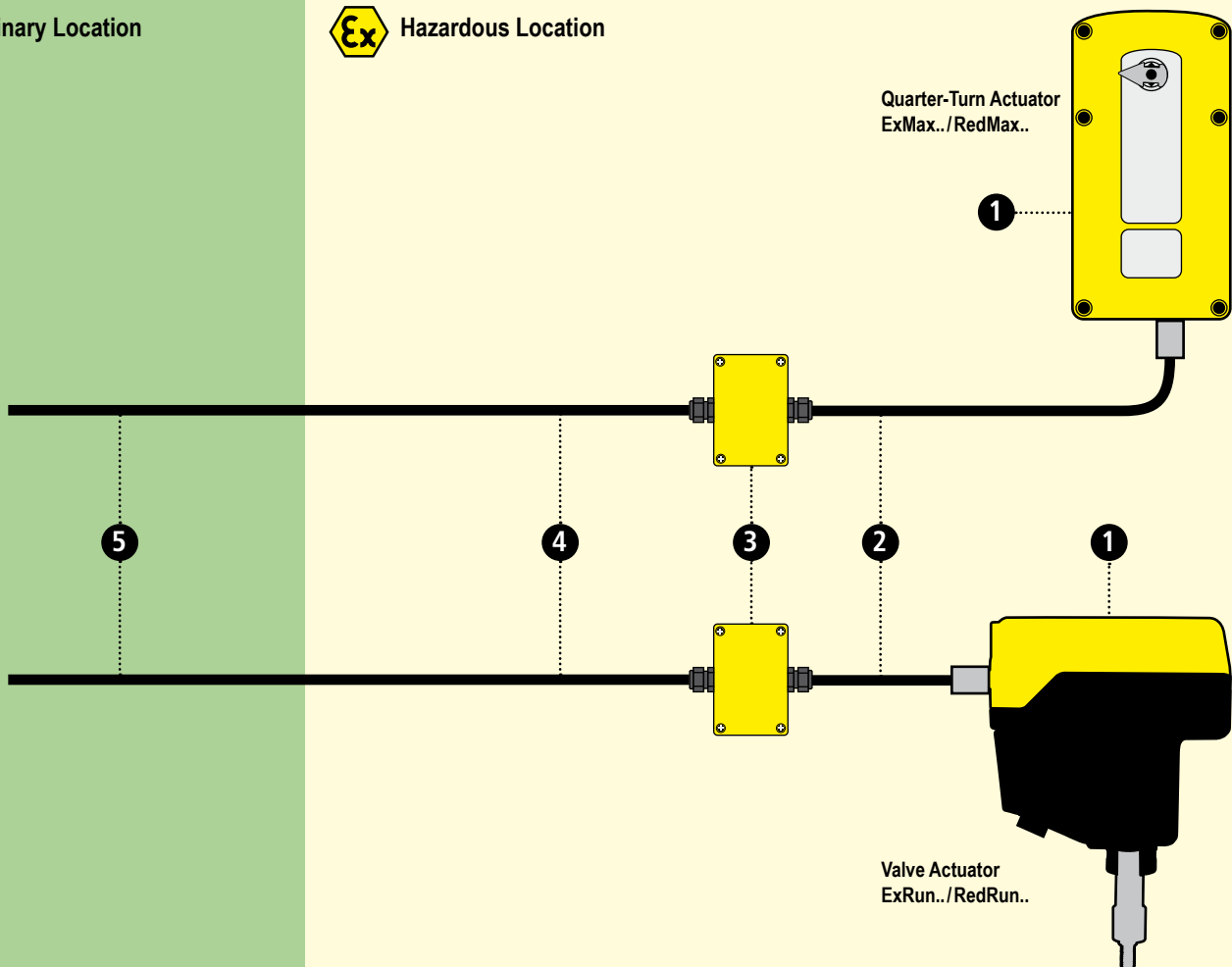

- 1 Explosion proof actuator (ExMax/RedMax, ExRun/RedRun)
- 2 Extension cable approximate 39.4" (1 m)
- 3 Junction box in increased safety Ex-e technology

- 4 Supply or control cable
- 5 Supply or control cable reaches into the ordinary location...

Features

Basic Information About Schischek Actuators in Combination with ExPro-TT-... and Programming Stick

Actuators ExMax.../ExRun...



Schischek Actuator Range

Figure 1: ExMax 1/4 turn actuator. Figure 1: ExRun valve actuator.

All actuators are based on the same concept of wiring, conduit NPT 1/2" thread, function and look. Each device has the same interface connection as well parameter setting. With one stick all types are programmable. Factory setting is the lower torque with respect to force and medium running time.

Actuator Back Details



Actuator Back Details

- a.) Interface for stick communication and for fire damper actuators (..Max-...BF-A versions) connector for thermal sensor ExPro-TT-...
- b.) 3 color LED for status indication
- c.) NPT 1/2" thread to connect conduit systems. Factory sealed, conduit seal is not required!
- d.) Push button to start actuator settings. e.g. adjustment drive to teach end-position for a soft-break in the end.

Programming Stick

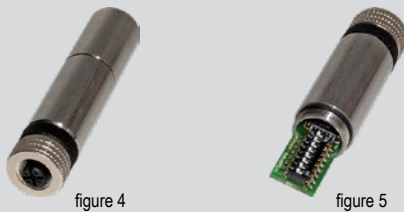

Programming Stick

Settings such as faster/slower motor running times (3, 15, 60 sec/90°) and faster spring return time (3 sec/90°) can be changed with the programming stick.

The stick can also be used in reading mode for diagnostic purposes.

ExPro-TT-...

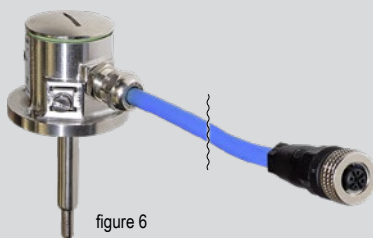

ExPro-TT-...

The thermoelectric safety limiter type ExPro-TT-... triggers the failsafe function on the motorized fire damper into its safety position by spring return operation of an ..Max-...BF-A actuator (fire damper actuator).

Mode of Operation

The temperature fuses are part of the sensor. In case that the ambient temperature inside or outside of the duct is more than 162°F (+72°C) the temperature fuse works. If one fuse is blown in the circuit, the spring return of the actuator moves the damper into its safety position. The ExPro-TT-... has a push button for easy function check.

Connecting Stick/ExPro-TT-... on Actuator

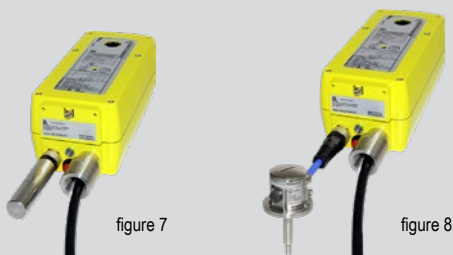

Connecting Stick/ExPro-TT-...

1. Remove protection cap
2. Put the stick (figure 7) or ExPro-TT-... (figure 8) plug into the interface connector
3. Screw tightly
4. For adjustments with the stick follow the manual
5. ExPro-TT-... connection LED green means "active"

Remove the Accessory

1. Unscrew the sensor or stick
2. Screw the cap back on to protect the connector (protection against liquids and dust)



Information About Electrical Installation Codes in Classified Areas According to NEC/FM/CEC

Regulations for Explosion Protection

Electrical equipment and systems for use in hazardous locations are covered by the National Electrical Code (NEC) in the USA, and the Canadian Electrical Code (CEC) in Canada. These assume the character of installation regulations for electrical systems in all areas, and they refer to a number of further standards from other institutions that contain regulations for the installation and construction of suitable equipment.

The installation methods for the NEC's Zone concept largely correspond to those of the traditional Class/Division system.

A new stipulation in the NEC 1996 is the use of metal-clad (MC) cables in addition to rigid conduits and mineral-insulated cables of Type MI in Class I, Division 1 or Zone 1.

Construction Requirements

The regulations of the National Electrical Code and the Canadian Electrical Code specify which equipment or types of protection can be used in the individual hazardous locations.

In North America, different standards and regulations apply to the construction and testing of explosion-proof electrical systems and equipment. In the US, these are primarily the standards of Underwriters Laboratories Inc. (UL), Factory Mutual Research, Corporation (FM) and the International Society for Measurement and Control (ISA). In Canada, it is the Canadian Standards Association (CSA).

Certification and Designation

In the US and Canada, electrical equipment and resources in workplaces subject to explosion hazard generally require approval.

Electrical equipment that cannot ignite the potentially explosive atmosphere in which it is used by virtue of its design or special properties, is an exception to this rule. The competent authority decides if approval is required.

Equipment that has been developed and manufactured for use in hazardous locations is tested and approved in the USA and Canada by nationally recognized testing agencies. In the USA, these include the testing agencies of the Underwriters Laboratories or Factory Mutual, and in Canada, the Canadian Standards Association. The UL and FM testing agencies are also the competent agencies for issuing approvals for Canada.

Any information relating to explosion protection must be shown on the marking of the equipment, along with information such as manufacturer, model, serial number and electrical specifications. The requirements for this are specified in the NEC, the CEC, and in the relevant construction regulations of the testing agencies.

Class I, II & III, Division 1 and 2 Approved electrical equipment must be marked to show the following information:

The Type Plate and its Components

- Class(es), division(s)
- Gas/dust group(s)
- Operating temperature or temperature class

Example: Class I Division 1 Groups C D T6

Class I, Zone 0, 1 and 2

In the case of equipment for use in Class I, Zone 0, Zone 1 or Zone 2, a distinction is made between "Division Equipment" and "Zone Equipment".

Division Equipment:

Equipment approved for Class I, Division 1 and/or Class I, Division 2, can also be provided with the equivalent zone marking:

- Class I, Zone 1 or Class I, Zone 2
- Gas group(s) IIA, IIB or IIC
- Temperature class

Example: Class I Zone 1 IIC T4

Zone Equipment:

Equipment that corresponds to one or more protection types in accordance with Article 505 and 506 of the NEC and Section 18 of the CEC must be labeled as follows:

- Class (optional in Canada)
- Zone (optional in Canada)
- Symbol AEx (USA) or Ex (Canada)
- Short codes of protection type(s) used
- Electrical equipment Group II or gas group(s) IIA, IIB or IIC
- Temperature class

Example: Class I Zone 1 AEx d ia IIC T6

Example, for the Labeling of an Actuator:

Manufacturer's name, manufacturer's address, designation of type, electrical data (V, A, W, Hz) ambient temperature if different from -40°F to +104°F, unit serial number, in addition to the classification of Ex protection.

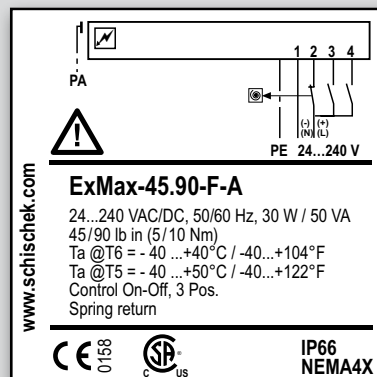

Correct Installation

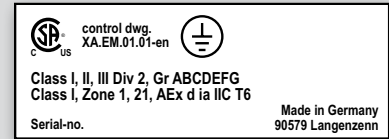

Responsibilities

The responsibility for compliance with all regulations and guidelines, from production to planning, up until installation, operation and maintenance, has greatly increased.

Each individual must be conscious about the fact that he accepts personal responsibility as part of a total project:

- building owner
- end-user
- architect
- consulting engineer/control company
- inspection authority
- contractor/installer
- manufacturer
- product supplier
- maintenance engineers

Main Differences Between US/CAN and European (IEC/EN) Installation:

US/CAN Electrical Code

- Installation according to Division and Zone System (NEC 500, 505 and 506) possible
- Conduit with Explosionproof seals
- Cable Tray
- Thread type and engagement
- Wire gauge/ampacity
- Grounding/bonding

IEC/EN Electrical Code

- Cable, with Cable glands
- Cable Tray
- Metric Thread type and engagement
- Wire gauge/current capacity
- Grounding/bonding

Interested to learn more about explosion proof? We are certified to issue PDH credits for our explosion proof basics seminar. Contact us!

Labeling of Explosion Proof Equipment in Accordance with NEC 500/505/506

Classification and Labeling of Hazardous Locations

Flammable medium	Hazardous locations Probability of a potential explosive atmosphere occurring	Classification of explosion proof areas	
		NEC 500	NEC 505 & 506
Gases, vapors, mists	Present continuously or for long periods of time	Class I, Division 1	Zone 0
	Likely to exist or they exist frequently	Class I, Division 1	Zone 1
	Not likely to occur, exist only for a short period	Class I, Division 2	Zone 2
Dusts	Present continuously or for long periods of time	Class II, III, Division 1	Zone 20
	Likely to exist or they exist frequently	Class II, III, Division 1	Zone 21
	Not likely to occur, exist only for a short period	Class II, III, Division 2	Zone 22

Classification Explosion groups & Temperature Classes

Explosion group	NEC 500 CEC Annex J	NEC 505, 506 CEC Section 18	
Gases	Acetylene	Class I, Group A	IIC
	Hydrogen	Class I, Group B	IIC
	Ethylene	Class I, Group C	IIB
Dusts	Propane	Class I, Group D	IIA
	Metal dust	Class II, Group E	IIIC
	Carbonaceous dusts	Class II, Group F	IIIB
	Non-conductive dusts	Class II, Group G	IIIB
Fibers and flyings	Class III		

Temperature Classes

Product use depending on temperature class (T1-T6). The temperature class indicates the max. temperature of the exposed surface of the product. As for dust explosion protection the max. surface temperature is directly shown. (e.g. T80°C)

Example Attention: this list is only an extract of possible flammable mediums and makes no claim to be complete!

T1	< 450 °C	Hydrogen
T2	< 300 °C	Acetylene
T3	< 200 °C	Petrol Diesel fuel
T4	< 135 °C	Ethyl Ether
T5	< 100 °C	
T6	< 85 °C	Carbon disulphide

Example Ex Marking according to NEC 500 and CEC Section 18

XP / Class I / Division 1 / Groups ABCD / T6
DIP / Class II, III / Division 1 / Groups EFG / T6

Example Ex Marking according to NEC 505/506

Class I / Zone 1, AEx d IIC T6
Zone 21 AEx tD T80 °C

Protection Principle – Type of Protection

Protection Principle	Type of Protection	Code	To use in		Symbol	Standard
			Div	Zone		
Prevents transmission of the explosion outside	Flameproof Enclosure	XP XP AEx d Ex d	1, 2 1, 2	1, 2 1, 2		UL 1203 C22.2 No. 30 ISA 60079-1 CSA 60079-1
Prevents high temperatures and sparks	Increased Safety	AEx e Ex e		1, 2 1, 2		ISA 60079-7 CSA 60079-7
Low current/voltage supply	Intrinsic Safety	IS IS AEx ia ib Ex ia ib	1, 2 1, 2	0, 1, 2 0, 1, 2		UL 913 C22.2 No. 157 ISA 60079-11 CSA 60079-11
Purged /pressurized	Pressurized Apparatus	Type X, Y, Z Type X, Y, Z AEx px, y, z Ex px, y, z	1, 2 1, 2	1, 2 1, 2		FM 3620 NFPA 496 ISA 60079-2 CSA 60079-2
Encapsulated	Encapsulation	AEx ma mb Ex ma mb		0, 1, 2 0, 1, 2		ISA 60079-18 CSA 60079-18
Parts immersed in oil to isolate from explosive atmosphere	Oil Immersion	AEx o Ex o		1, 2 1, 2		ISA 60079-6 CSA 60079-6
Parts immersed in powder / sand to isolate from explosive atmosphere	Powder Filling	AEx q Ex q		1, 2 1, 2		ISA 60079-5 CSA 60079-5
No arcs, sparks or hot surfaces	Protection "n"	NI NI AEx n Ex n	2 2	2 2		UL 1604 C22.2 No. 213 ISA 60079-15 CSA 60079-15
Dust ignition proof	Protection by enclosure "t"	DIP DIP AEx t DIP	1, 2 1, 2	20, 21, 22 20, 21, 22		UL 1203 C22.2 No. 25 ISA 60079-31 CSA 60079-31
Dust protected	Protection "NI" for Class II	DIP DIP	2 2			ISA 12.12.01 C22.2 No. 25
Dust ignition proof by Intrinsic Safety	Protection "ia"	IS IS AEx ia Ex ia	1, 2 1, 2	20, 21, 22 20, 21, 22		UL 913 C22.2 No. 157 ISA 60079-11

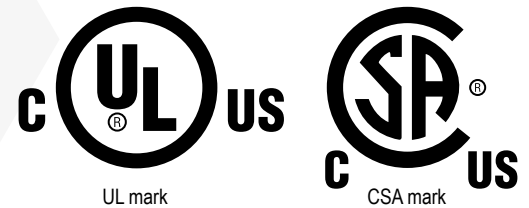

Ingress Protection (IP) EN 60529

IP	Protection Against Solids/Dust	Protection Against Water	NEMA/TYPE Ratings vs. IPxx	
8	–	protected against long periods of immersion	Type 1	IP10
7	–	protected against the effects of temporary immersion	Type 2	IP11
			Type 3	IP54
6	totally protected against dust	protected against strong jets of water	Type 3R	IP14
			Type 3S	IP54
5	protected against dust – limited ingress	protected against low pressure jets from all directions	Type 4	IP56
			Type 4X	IP56
4	protected against solid objects > 1 mm	protected against direct sprays from all directions	Type 5	IP52
			Type 6	IP67
3	protected against solid objects > 2.5 mm	protected against direct sprays up to 60° from vertical	Type 6P	IP67
			Type 12	IP52
2	protected against solid objects > 12.5 mm	protected against direct sprays up to 15° from vertical	Type 12K	IP52
			Type 13	IP54
1	protected against solid objects > 50 mm	protected against vertical falling drops of water		
0	no protection	no protection		

Where and When do I Have to Take Explosion Proof into Consideration ?

Explosion Proof Means: "Protection of Life. Health. Assets."

When does the danger of an explosion occur ?

A danger of explosion occurs when a flammable medium (gas, vapor, mist or dust) is present in a dangerous quantity.

When does an explosion occur ?

An explosion may occur when the following 3 components are present at the same time:

- Flammable or combustible media
- Oxygen
- Source of ignition

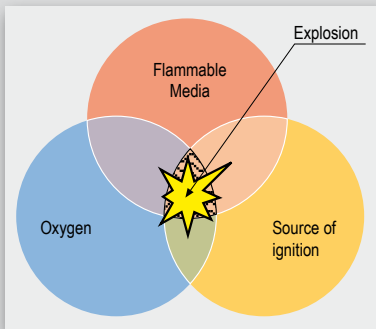

Typical sources of ignition

Very often the cause of an accident is self-ignition, hot surfaces and mechanically generated sparks. But there are also a lot of other sources of ignition, caused by either mechanical and/or electrical equipment:

- Self-ignition
- Extraordinary surface temperatures
- Open flames
- Mechanically generated sparks
- Static electricity
- Lightning strike
- Ultrasonic
- Chemical sources of ignition
- Electric sparks
- Electric arcs
- Adiabatic compression
- Adiabatic shock waves
- Electric circulating currents

Is your system safe ?

We have the following situation NOW or in the FUTURE:

Yes.No (Please check)

- Flammable materials are stored.
- Flammable materials are used.
- Flammable materials are bottled.
- Flammable materials are used during the cleaning process.
- Flammable materials are used in the production process.
- Flammable materials will be produced during the production process.

If you answered yes to any of the above listed situations you will need to consider the rules, regulations and instructions concerning explosion protection!

Remarks:

All information, tables, checklists and further documentation are only for your assistance and do not claim to be complete. In no way do they replace official regulations and rules or even laws by the authorities. We want to point out that it is very important to undertake all measures for an exact classification of the Ex-area.

Typical Applications:

- Chemical, pharmaceutical and industrial plants
- Refineries, petrol depots, gas stations
- Paint and solvent shops
- Drying and coating cabinets
- Laboratories in industry and schools
- Water treatment works, power plants
- Compressor stations, gas works
- All kinds of storekeeping and stocks
- All kinds of filling stations
- All kinds of cleaning stations
- Mills, silos, silos for bulk goods
- Offshore and onshore
- Oil and gas pipelines
- Printing works, food industry, ...

Schedule:

- Analyse whether you need explosion protection or not
- Ask experts in order to analyse the risk
- Define zones, areas, categories, explosion groups and temperature classes
- Planning according to all necessary rules and regulations
- Choose the best supplier and the right product
- Keep to the installation rules
- Check the labelling of the equipment
- Make sure that the appliance will be put into operation correctly
- Confirm a final inspection by the responsible authority
- Guarantee regular and correct maintenance according to the regulations
- The correct documentation has to be maintained

From combustion to detonation

Effect and reaction velocity increase significantly from combustion, deflagration, via explosion up to detonation. Explosions are more likely with gaseous media and detonations with dust media.

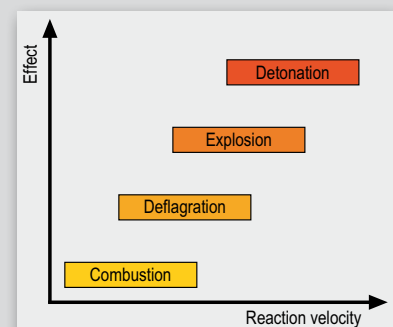

Classification of Hazardous Locations

Introduction

Hazardous Location Classification

In the United States the following methods are now allowed:

The traditional method based on Article NEC 500, and according IEC the NEC 505 method, allowed for the first time in 1996, and, since 2005, also NEC 506.

The Traditional Area Classification Method

The traditional area classification method uses three descriptors: Class, Group, and Division plus extent to describe an area's classification. In addition, with regards to electrical equipment which may have exposed hot surface temperatures that could serve as an ignition source, the area's temperature class is also specified.

There are Three Classes:

CLASS I - Flammable gases, vapors, and flammable and combustible liquids;
CLASS II - Combustible dusts; and
CLASS III - Ignitable fibers or flyings.

The group descriptor is used to classify the material's flammable and explosive properties. There are seven groups: Groups A-D, which are Class I groups, and Groups E-G, which are Class II groups. Class III does not have any groups.

The division descriptor defines the likelihood that the hazard will exist in the classified area.

Division 1 is where the hazard is considered to exist under normal conditions, which include during repair or maintenance activities, during leakage, or where faulty operation of equipment or process could release a flammable mixture and cause a simultaneous failure of electrical equipment.

Division 2 is where the hazard is considered to exist due to abnormal conditions such as accidental rupture, breakdown, or abnormal operation; or due to a failure in positive mechanical ventilation systems. Also, an area is considered Division 2 if it is adjacent to a Division 1 area where the hazard may be occasionally communicated to the Division 2 area.

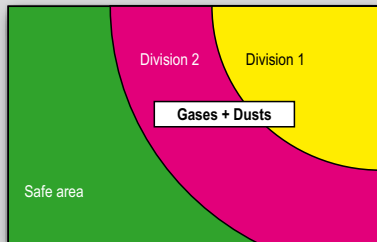

An example of a typical division classification.

Classification Division-Zone and Labeling of Hazardous Locations

By definition, any area not classified as hazardous is classified as non-hazardous. An area classified as non-hazardous may, still have additional requirements placed on it such as NEC Article 500.3 or by the local authority having jurisdiction because of the proximity of the hazardous materials.

Division into Zones

Potentially explosive areas should be divided into zones, and the equipment should be divided into groups and categories. The labeling on the identification plate of certified equipment indicates in which zone the explosion proof equipment can be used.

Zone classification

Zone 0, 20 Continuously hazardous
Zone 1, 21 Frequently hazardous
Zone 2, 21 Infrequently hazardous
Zone 0,1, 2 is for gases and 20, 21, 22 is for dusts.

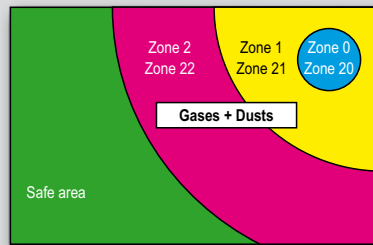

An example of a typical zone classification.

Division into Equipment Groups

Groups are divided into group I and group II. Group I equipment is intended for use in underground parts of mines. Group II equipment is intended for use in areas where explosive atmospheres exist, except for underground mines.

Division into Explosion Groups

Explosion proof equipment for gases, mists and vapors are divided into three explosion groups (IIA-IIB-IIC) according to the type of protection being used. The explosion group is a means to measure the ignitability of gases (potentially explosive atmospheres). The equipment requirements increase from IIA to IIC.

Division into Temperature Classes

Explosion proof equipment, installed within the Hazardous location, is divided into temperature classes (T1 to T6). Temperature class is not – as it is often wrongly believed – the operating temperature range of the equipment, but the maximum permissible surface temperature of the equipment, in relation to +40°C ambient temperature on any surface area, and should not be exceeded at any time. The maximum surface temperature must remain below the ignition temperature of the surrounding medium at all times. The equipment requirements increase from T1 to T6.

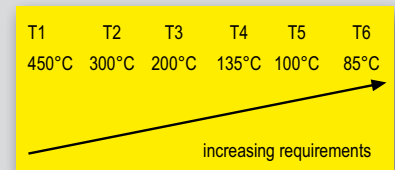

Division and Zone System Comparison

Similarities and Differences of Division/Zone Systems in Hazardous Locations

What are the differences between the Zone and Division systems in hazardous (classified) locations? Here is what you need to know.

Zone or Division?

What are the similarities and differences? It seems so confusing, but it doesn't have to be. A good way to understand the Zone system is to compare and contrast it with the familiar Division system rules and methodologies. This makes sense because they both have the same goal: To promote safety by defense against the ignition of flammable gases by electrical arcing or electrically heated surfaces. Also, both systems work with the same natural laws of physics and chemistry, such as gas ignition temperatures and combustible percentages of volatile gases.

National Electrical Code

Looking at the rewritten articles 505 and 506, we see it provides for the use of the Zone Classification system, detailing the different gas and dust groupings, protection philosophies, and types of equipment from the Division system. If you don't understand the new terms and concepts, you'll end up applying the installation rules at the end of articles 505 and 506 strictly by rote, and that doesn't work well in the long run.

The NEC Committee rewrote article 505 because the Division Classification system and IEC system are too different to merge. For example, list the IEC and NEC Group classifications for the different gases in ascending order of "More Easily Ignitable." Then, note that the group denoted with an "A" in the IEC area is the least ignitable, while the group denoted with an "A" in the NEC group is the most ignitable. Also, the IEC system uses three groups for the representative gases while the NEC system uses four. To further confuse the two systems, the IEC and NEC do not use the same terminology, and neither have the same number of categories to identify the likelihood of the hazard being present.

The NEC is an installation standard. With the exception of a few specific occupancies (e.g. article 511 for commercial garages, or article 515 for bulk storage plants), the NEC does not make area classifications. Even those special articles generally consist of material extracted from other NFPA documents, where the heavy lifting gets done as to the boundaries of various hazardous (classified) areas. This is because the NEC is an installation document, not an occupancy document, and NFPA operating procedures clearly distinguish the functions of both.

For example, what would you use to decide area boundaries in a refinery? The American Petroleum Institute (API) RP 500, Recommended Practice for Classification of Locations for Electrical Installations at Petroleum Facilities Classified as Class I Division 1 and Division 2, would be the best place to start. This widely used API document defines the extent of classified areas in refineries operating under the Division system.

IEC/EN Zone System

Now suppose you're proposing to do the same thing, but under the Zone system. The IEC 60079-

10 series provides rules and standards about how to define and develop the extent of a Zone-classified area. Appendix C of IEC 60079-10-1 contains examples demonstrating the results of the applications of the rules found in the body of the IEC 60079-10-1 document.

Where API 500 classifications interface with IEC installations, there are obvious differences. For example, IEC Zone 0 and Zone 1 are included within Division 1 of the NEC. The IEC has three Zones, and the NEC has two Divisions. This causes some of the major differences between the two systems. Also, reclassification of Division locations into Zone locations brings out these differences. For example refer to NEC 505.7 (B) and (C).

Direct Comparisons Between NEC and IEC Rules

Here's a quick comparison and contrast between the two systems.

Comparison of Overall Methodologies

Both Division and Zone classification systems begin with defining what the hazard is and the probability the hazard will be present.

Classes and Groups According to NEC 500/505

Comparison of how the hazards are defined. The NEC Division system uses Classes and Groups to identify the hazard. The classes are used to represent gases, types of dusts, or fibers:

- Class I represents flammable gases
- Class II represents explosive dusts
- Class III represents hazardous fibers

Groups further define the hazard in Class I and II locations. For Class I, Groups A (acetylene), B (hydrogen and similar gases), C (ethylene and similar gases), and D (propane and similar gases) represent flammable gases. Note: Hazardous Dusts and fibers are not treated in article 505 but in article 506.

Groups and Zones According to IEC/EN Zone System

The IEC Zone system identifies the hazard by two main Groups:

- Group I for mining (underground locations) and Group II for surface (not underground) industries. (Note: Article 90.2 (B) (2) states the NEC doesn't cover underground mining installations.)
- Group II is divided into three subgroups arranged in order of hazard due to threat of ignition: A (the most difficult to ignite, such as propane); B (gases such as ethylene); and C (the easiest to ignite, such as acetylene/hydrogen).

Comparison of Hazard Probability

The NEC Division system categorizes locations as Division 1 or Division 2 based on the rules found in section 500.5.

A Class I Division 1 Location is Where:

- Concentrations [refer to NFPA 497 for the percentage volumes of gases that will burn, since too little or too much gas won't burn] of flammable gases or vapors that would be ignitable under normal operating conditions
- Hazardous gas mixture(s) may exist frequently because of repair or maintenance operations or leakage, or
- The breakdown of equipment simultaneously re-

leases hazardous gas and causes failure of electrical equipment.

A Class I Division 2 Location is Where:

- Volatile flammable liquids are handled or stored, but they are normally confined within closed containers from which they can escape through container rupture, or
- Positive ventilation normally prevents ignitable concentrations of vapors (that is, the quantity of clean air continually brought into the atmosphere prevents the hazardous gas concentration from reaching its lower explosive limit percentage), or
- The area is adjacent to a Class I Division 1 location from which hazardous concentrations of gas may occasionally be transported.

The IEC/CENELEC approach uses three Zones instead of two Divisions. The Zones are based on how often the hazard is present instead of whether the hazard is present "normally." A Fine Print Note (FPN) in section 505.4 directs the reader to IEC 60079-0 for specific information about classifying areas as hazardous. This is also CENELEC EN 60079-10-1, Electrical Apparatus for Explosive Gas Atmospheres, Classification of Hazardous Locations. It provides specific definitions of zones, as follows:

Zone 0 location is "...an area in which an explosive gas atmosphere is present continuously or for long periods."

Zone 1 location is "...an area in which an explosive gas atmosphere is likely to occur in normal operation."

Zone 2 location is "...an area in which an explosive gas atmosphere is not likely to occur in normal operation, and if it does occur, is likely to do so only infrequently and will exist for a short period only."

The Zone system makes extensive use of the Lower Explosive Limit (LEL) concept. That is, if the amount of flammable gas in the atmosphere mixture is below the LEL for the gas, then the mixture is too lean and won't burn. A large part of the IEC 60079-10-1 document is about methods that are intended to keep the atmospheric mixture below the LEL for the gas. However, the "...likely frequency of release, the release rate, the concentration, the velocity, the ventilation, and other factors all affect the Zone classification."

Zone 0: the biggest difference. The concept of Zone 0 is a big difference. No amount of ventilation can change a Zone 0 area to some lower classification, and the IEC general method of treating Zone 0 locations is to eliminate the hazard from within these locations by eliminating all electrical devices, cables, and loads from Zone 0 locations. In the final analysis of the Zone rules, the only types of electrical items you can install within Zone 0 locations are intrinsically safe and encapsulated types. You'll find Zone 1 locations roughly equivalent to Division 1 locations, and Zone 2 locations roughly equivalent to Division 2 locations.

How We Got from Division to Division and Zone

Comparisons Between Division and Zone Classifications NEC 500/505/506

Acceptable wiring methods. After section 505-10, subsequent sections of article 505 define the acceptable wiring methods for Zone 0, 1, and 2 locations, required markings for equipment to be placed in each Zone, and specifics about how to treat unique loads, such as "increased safety" motors in these locations.

by John Paschal, Jr., P.E.

In 1947, the NEC first recognized different levels of risk exist in hazardous locations. Consequently, it established Division 1 and Division 2, to provide a means to treat the issue. The permitted installation methods to be specified are based upon what was considered an acceptable level of risk.

The IEC rules advanced the NEC logic to a new level. The IEC recognized the NEC divisions were based more on whether the hazard was present under either normal or abnormal conditions, instead of on the duration of the hazard. Therefore, the IEC established three divisions, or Zones, that are based on how often the hazard is present rather than upon normal versus abnormal conditions.

The three zones break the NEC's Division 1 into two distinct zones, one of which (Zone 0) is for those locations that are the most hazardous because they remain hazardous for a long time. Separating Zone 0 from the remainder of what is Division 1 in the NEC system permits a more refined treatment of the hazards of the two zones. It restricts methods of protection in Zone 0 while permitting more relaxed method of protection in Zone 1 locations.

The Division system in section 505.6 of the Code describes the grouping for the Zone system by gas, according to permissible gap range and minimum ignition currents. This section provides specific "go-by" information for each gas group. Similarly, section 505.9 and its FPN point to NFPA 497-2012 for gas temperatures for use with either Division or Zone classifications. On the other hand, the Zone system uses some types of protection not recognized by the Division system.

Other Comparisons Between Division and Zone Classifications

To help you in your new IEC-related work (if you're well-grounded in the use of the Division system), here are valuable comparisons you should know.

- The Division system uses flame path cooling in Division 1 and Division 2 locations; but, the Zone system does not allow this "flameproof" methodology in Zone 0.
- For all practical purposes, the T-ratings for both systems are identical.
- The Zone system allows intrinsic safety with two fault conditions applied (ia), as the Division system permits, and a lesser form of intrinsic safety that is only safe with one fault applied (ib).
- In the Division system, purging and pressurizing is permitted in all locations; but, in the Zone system, this is not permitted in Zone 0 locations.

- The use of "increased safety" protection isn't recognized by the Division system; but the Zone system permits its use in all but Zone 0 locations.

- Encapsulation (Ex m) isn't a recognized protection method in the Division system; but the Zone system uses it frequently.

- "Special Protection" is not recognized within the Division system; but the Zone system allows a mechanism whereby apparatus and equipment can be certified to be safe and workable in a given location, though it does not comply with the other recognized forms of protection.

- The Division system maintains a listing of types of enclosures, such as NEMA 4, or 7, 12, while the Zone system maintains the Ingress Protection (IP) system. The IP system designates, by means of a number, the degree of protection provided by an enclosure against solid objects. It also has a second number to designate the degree of protection provided by the enclosure against water ingress. For example, an IP number of 54 would eliminate the possible ingress of dust and protect against splashing water from any direction.

- Equipment listed for a Zone 0 can also be installed in Zone 1 or 2.

- Equipment must be marked with the Class, Zone, Group, and Temperature classification, except that intrinsically safe equipment is only required to be marked with the symbol AEx, the protection technique, and with the gas group. The FPN in NEC section 505.9(C) provides an example of the equipment marking system for Zone applications.

NEC 500 Division System NEC 505 + 506 Zone System

About US Codes

No one should trifle with the safety of personnel and equipment deployed in areas where there are or may be flammable or explosive atmospheres. Standards for dealing with such hazardous locations have been established based on caution and experience. But the 1996 National Electrical Code (NEC) was modified to incorporate International Electrotechnical Commission (IEC) standards in addition to the existing code. Comparison of the two methodologies shows the effects and benefits.

Area classification is the methodology used by the NEC to classify areas as to the nature, the likelihood, and the extent of ignitable flammable hazards that could exist where electrical equipment could be installed. The area classification can be used then to select the proper electrical equipment and wiring methods for a safe installation.

The primary intent of area classification is to prevent fires and explosions that could be caused by electrical equipment serving as an ignition source (arc, spark, high temperature, etc). Electrical area classification applies only to areas where electrical ignition sources can exist. Areas where mechanical or process ignition sources exist are a separate consideration. However, if these types of hazards exist all the time, then the area immediately adjacent to the ignition source is not normally electrically classified.

Area classification is defined in National Fire Protection Association (NFPA) - 70, "The National Electrical Code," Chapter 5 (Special Occupancies), Article 500. NEC Articles 501-506 and 511-516 further define the requirements for hazardous (classified) areas. Other articles in the NEC also refer to the articles in Chapter 5 for requirements.

Other NFPA standards such as NFPA-30, "Flammable and Combustible Liquids Code", NFPA-30A, "Code for Motor Fuel", NFPA-45, "Standard on Fire Protection for Laboratories using Chemicals" NFPA-58, "Liquefied Petroleum Gas Code" etc., also contain requirements with regard to hazardous location installations. Article 500.5 lists references related to area classification. The requirements for area classification are not provided in a cookbook manner but rather require the use of technical expertise and sound engineering judgment.

Certification with Highest Protection Classes

CSA • UL • EAC • IECEx • ATEX • KOSHA • INMETRO • NEMA • IP66 • DNV-GL



CSA is a global provider of testing and certification services. CSA is also on the OSHA list of nationally recognized testing laboratories, NRTL.



UL is an independent organization that tests and certifies products with regards to safety. UL tests and evaluates compliance of products, components, materials, and systems against specific requirements. As a result the UL mark can be carried as long as the standards are complied with. UL is one of the OSHA endorsed testing labs. OSHA is the Occupational Safety and Health Administration and maintains a list of labs called NRTL, short for nationally recognized testing laboratories.



In the context of the Eurasian Customs Union new technical rules were continuously introduced since June 12, 2012 in order to create a common economic area. This also affects equipment intended for use in potentially explosive atmospheres. As part of this change, the GOST-R Explosion protection certificate was replaced by the new technical regulation TR CU 012/2011 "On the safety of equipment for use in potentially explosive atmospheres". Instead of the previously required GOST-R Ex certificate, it is now necessary to obtain a EAC certification. Likewise, the RTN approval process has been replaced by the TR CU regulations.

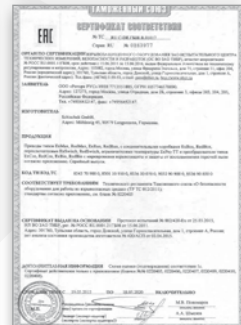

IECEx is an internationally used process to certify electrical equipment used in hazardous locations. The code defines a system to classify locations with potentially explosive atmospheres caused by gases, dusts, or fibers for example. The main goal of the International Electrotechnical Commission IEC with the IECEx regulation is to reach global harmonization of codes governing use of electrical apparatus in hazardous locations. IEC promotes mutual acceptance of evaluations and reports among the testing labs and certifying bodies.



ATEX is a commonly used synonym for the ATEX directives of the European Union. The name is derived from the French term "ATmosphère EXplosible". The directive encompasses explosion protection directives 2014/34/EU for equipment and 1999/92/EG for work areas. ATEX directives are devised by the Director General of the EU commission Enterprise and Industry in cooperation with the member states, standardization organizations (CEN, CENELEC) and so called "Notified Bodies" such as BAM, PTB, or TUEV to name examples from Germany.



Certification with Highest Protection Classes

CSA • UL • EAC • IECEX • ATEX • KOSHA • INMETRO • NEMA • IP66 • DNV-GL



KOSHA (Korea Occupational Safety and Health Agency) aims to contribute to the national economy by maintaining and improving the safety and health conditions at work through the efficient implementation of projects such as research and development, promotion of industrial accident prevention technologies, provision of technical assistance and training on occupational safety and health, inspection on dangerous facilities and equipment.



INMETRO (National Institute of Metrology, Quality and Technology) is Brazil's government body responsible for the implementation of measurement, safety and quality standards for electrical and electronic products. It guides the activities of accreditation, inspection, testing and certification bodies in the country.



NEMA is the National Electrical Manufacturers Association that defines standards used in North America for all kinds of enclosures intended for use in industrial applications. Depending on NEMA type, enclosures are rated to protect against personal access to hazardous parts and certain environmental conditions such as water, dust, oil or coolant or even corrosive atmospheres.



IP66 stands for Ingress Protection and denotes the protection of the device against environmental factors, dust and rain for example, as well as protection of living beings against dangers of touching high voltage circuits for example. The first digit categorizes ingress of solid objects, the second ingress of water:

- IP6X = dust proof
- IPX6 = water jet proof (with specifies water pressure etc.)



DNV GL offers classification and certification of ships as well as technical assurance along with independent expert advisory services for the oil & gas and energy industries. As a classification society they set technical rules for design and construction of ships and issues them as design rules. Design rules do not only contain strength calculations for design and dimensioning of ship constructions but also technical requirements for installed equipment.



Valve Automation

Quarter-Turn Actuators

..Max
1/4-Turn Actuator

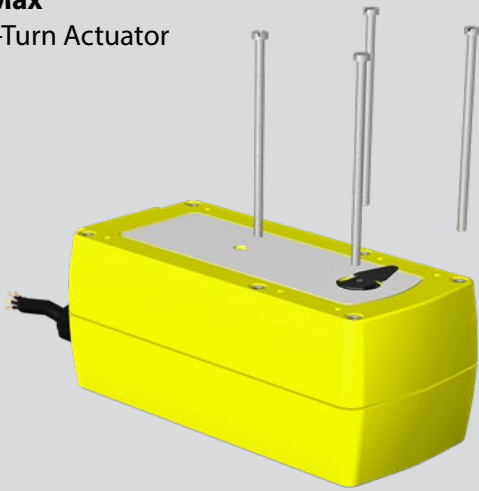

Valve Linkage
Example

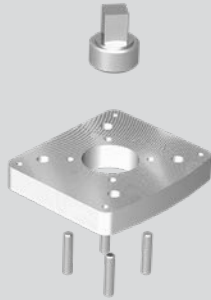

Valve
Example



Linear Motion Actuators

..Run
Linear Actuator



Valve Linkage
Example



Valve
Example

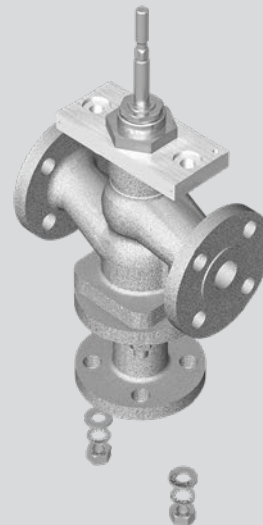

Valve Automation

Schischek Valve Linkages

Option 1

You make the linkage yourself or source it somewhere else. In that case we would be happy to provide you with all the actuator dimensions necessary to do so. We can even give you STEP files you can import directly into your CAD system.

SCHISCHEK EXPLOSIONPROOF				Title ExMax 5.10-Y / 15.30-Y Dimensions			
Project	Actuator	Signed	...	Project	Actuator	Checked	...
Substitute for	ExMax	Approved	...	Origin	Schischek GmbH	Approved	...
Origin				Drawing No.	090.0000.A4_Dimensions	Rev	...
AB				Scale	1:2	Sheet	1 / 1
Rev	Description	Date	Via	Project No.		Scale	1:2

Option 2

Schischek designs and delivers the linkage

We can quote you a price for a linkage for any typical valve mounting pattern and stem (for example ISO 5211) without knowing the exact valve dimensions.

When you order the linkage however, we need the dimensions of the top plate/mounting pattern as well as the stem shape and dimensions to design the linkage. The cut sheet for your valve will typically have that information. Simply send us the cut sheet and we will do the rest.

- A -		- B -		- C -		- D -	- E -	- F -	- X -	- Y -	- Z -
Square	Two flat	Fitting key	Flange type DIN 5211	Thread	Hole diameter	Height	Flange thickness	Distance	Torque	Nominal size	Material
9	9	12	F03	M	mm	mm	mm	mm	Nm	DN	standard
		14	F04	UNC	Zoll	Zoll	Zoll	Zoll	lb-in	Zoll	VA
		18	F05	UNF	Zoll	Zoll	Zoll	Zoll	- U -	- V -	AISI 316
		22	F07								
			F10								
			F12								
			Other								
mm	mm	mm	mm								
Zoll	Zoll	Zoll	Zoll								

Customer	Country	Project
Actuator type	Armature	
	Type	Manufacturer

SCHISCHEK EXPLOSIONPROOF				Title ExMax on ball valve			
Project	Actuator	Signed	...	Project	Actuator	Checked	...
Substitute for	ExMax	Approved	...	Origin	Schischek GmbH	Approved	...
Origin				Drawing No.	2011.070.E0-USA	Rev	...
AB				Scale	1:1.5	Sheet	1 / 1
Rev	Description	Date	Via	Project No.		Scale	1:1.5

Keeping the World Flowing

Since 1957, Rotork has grown to be a major international business with subsidiaries all around the world.

When you turn on a tap or switch on a light, turn on a kettle or put fuel in your car, a flow control product is being used somewhere in the process of delivering that service.

We are recognised as global leaders, designing and building the most reliable products, backed up by highly acclaimed customer service.

Rotork has established manufacturing facilities, a global network of local offices and agents who can truly provide a worldwide service. You will be able to locally source Rotork's products, supported by life-of-plant maintenance, repair and upgrade services.

Committed to Innovation

At every stage in the company's history, Rotork's engineers have focused on solving customer challenges and developing new solutions with levels of engineering skill and creativity that our competitors still cannot match.

With every product that Rotork develops, you can be sure of one thing: That quality and reliability are an integral part.

Serving the World

Rotork has always been committed to global supply, supporting operations in some of the most remote and challenging environments.

We have established manufacturing facilities across the globe which together with our own global network of local offices, regional *Centres of Excellence* and agents provide over 800 Rotork outlets worldwide.

"For over sixty years, engineers have relied upon Rotork for innovative, dependable solutions to manage the flow of liquids, gases and powders. From safety systems that may be needed just once in a lifetime to process controls that are constantly on the move, Rotork flow control products remain the clear choice, worldwide".

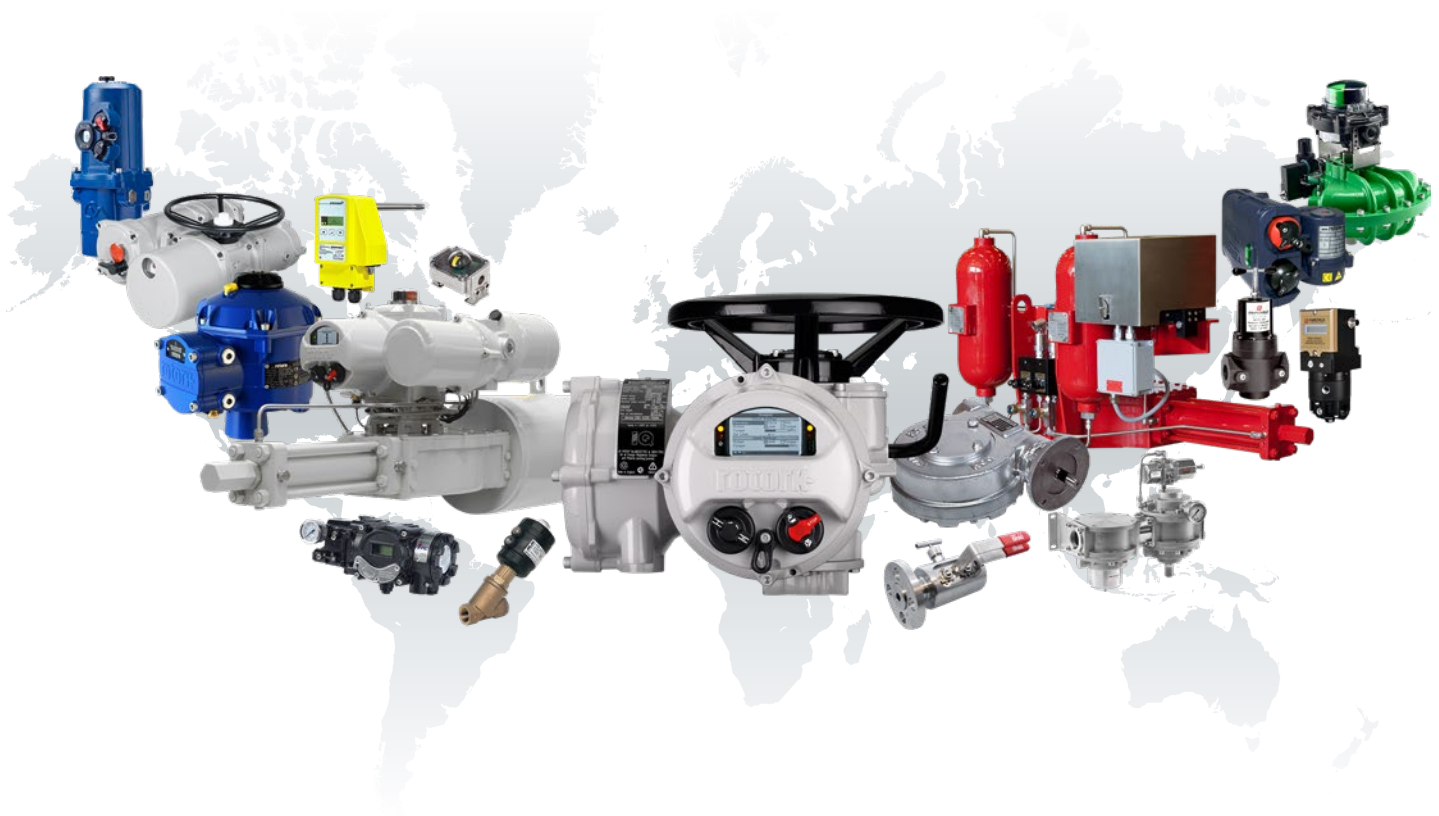

Electric Control Valve Actuators and Gears (Extraction)

IQT range



Multi-turn and part-turn electric actuators

IQT part-turn 1-phase, 3-phase and DC electric actuators are designed for isolating or regulating duties (S2 & S3/Class A & B) of up to 1,200 starts per hour.

- Direct torque output range from 50 to 3,000 Nm
- Continuous position tracking at all times, even without power
- Extended life and mounting in any orientation with oil bath lubrication
- IP66/68 certified
- Safe, motor-independent, handwheel operation available at all times
- Explosionproof and certified for safety applications (SIL2/3) are available

CK range



Modular design electric valve actuators

CK range actuators are suitable for valves in non-hazardous locations. The modular product range facilitates a number of different control package configurations to meet your application requirements.

- Multi-turn output torque up to 10,800 Nm (8,000 lbf.ft)
- Part-turn output torque up to 205,600 Nm (151,600 lbf.ft)
- Modular design provides an off-the-shelf solution for spares and upgrading
- Plug and socket connection for easier field wiring
- Continuous valve position indication even during power loss
- Non-intrusive setting via infrared or optional *Bluetooth*® with the intelligent CKc - Centronik module
- Hollow output drive to accept rising valve stems
- Detachable base options
- Secure manual handwheel drive fully independent of the motor drive train
- IP68 rating (8 m for 96 hrs) as standard provides enhanced environmental protection

ROM/ROMpak ranges



Compact and lightweight part-turn actuators

Electric, compact and lightweight part-turn actuators with efficient and simple gearing.

- Torque range 8 to 800 Nm (6 to 590 lbf.ft)
- On/off duty, manual override, self-locking, ISO flanges
- Available with local controls and phase rotation correction
- Wide range of supply voltages available
- 1-phase, 3-phase and DC power supply options
- Watertight IP68 rating
- High speed variant available
- Mechanical and LED local position indication
- Options: Bus communication, analogue control and feedback

Gears... ranges



Valve gear operators and accessories

Rotork offer a wide range of gearboxes spanning the following categories:

- Part-turn output manual gear operators
- Part-turn output motorised gear operators
- Multi-turn output manual gear operators
- Multi-turn output motorised gear operators
- Specialised application gear operators
- Mounting kits and accessories

Electric Control Valve Actuators (Extraction)

CMA range



CMA 1500 (Linear)



CMA L (Linear)



CMA Q (Part-turn)



CMA R (Multi-turn)

Linear, part-turn and multi-turn actuators

The Rotork CMA delivers a range of sizes suitable for almost all linear, part-turn and multi-turn control valves and other applications requiring exact position control and continuous modulation. Suitable for demanding applications including control valves, metering and dosing pumps.

- CMA Linear up to 20 kN (4,500 lbf) seating thrust
- CMA Q Part-turn up to 124 Nm (1,100 lbf.in) seating torque
- CMA R Multi-turn up to 45 Nm (400 lbf.in) rated torque
- Powered by 1-phase or DC supplies
- Continuous modulation to S9 (IEC 60034), Class D duty (EN15714-2)
- Permanently lubricated and maintenance free drive train

- Accurate and repeatable position control
- 4-20 mA loop powered feedback signal
- Options:
 - local controls including positional display
 - Reserve Power Pack (RPP) including local controls and positional display
 - configurable ESD input for end of travel or stayput emergency shutdown function

CVA range



CVA L (Linear)



CVA Q (Part-turn)



CVA L-5000 (Linear)

Linear and part-turn precision modulating actuators

- CVA L Linear: thrust range 890 to 22,241 N (200 to 5,000 lbf)
- CVA Q Part-turn: torque range 54.2 to 271 Nm (480 to 2,400 lbf.in)
- Compact, viable alternative technology when good quality instrument air is not available in hazardous areas
- Ultra-low energy consumption, suitable for solar powered applications
- Continuous, unrestricted modulation to S9 (IEC 60034), Class D duty (EN15714-2)
- Unparalleled accuracy, repeatability, resolution and stiffness
- Perfect for demanding applications including control valves and metering pumps
- Comprehensive data logging

- Analogue, digital and network control options
- Watertight IP68, NEMA 4 & 6, explosionproof enclosures
- Non-intrusive setup / calibration using *Bluetooth*® wireless technology
- Options:
 - 1-phase and DC power supply options
 - *Pakscan*™, HART®, Profibus®, Foundation Fieldbus® and Modbus® available
 - Programmable fail-to-position option
 - Hardwired control
 - Intrinsically safe I/O connections
 - Manual override

Fluid Power Actuators (Extraction)

K-TORK range



Pneumatic vane actuators

- Pneumatic actuators in double-acting and spring-return configurations
- Compact no-sideload, constant-torque design with output to 18,300 Nm (13,497 lbf.ft)
- Certified to IP66M/IP67M and meets NEMA 4/4X
- Certified to ATEX 2014/34/EU
- Complies with ANSI/AWWA C540-02 and C541-08
- Conforms to VDI/VDE 3485 control accessory mounting standards
- Modulating accuracy of 0.25% or better
- Capable of millions of operations at fast cycle times

GT/GTS ranges



Pneumatic rack and pinion actuators

- Double-acting and spring-return pneumatic actuators
- *NEW: now also available in stainless steel (GTS range)*
- Torque output up to 15,300 Nm (GTS range 1,190 Nm)
- Fail close/fail open
- Extruded aluminium body with cast aluminium end caps (GTS range in stainless steel 316L)
- Mechanical interfaces to ISO 5211, EN 15714-3-4, NAMUR VDI/VDE 3845
- Certified to ATEX 2014/34/EU
- Certified up to SIL3 as a single device (IEC 61508) by GT range
- Travel stops in both open and close direction (GTS range)

RC200 range



Compact scotch yoke actuators

- Extremely compact scotch yoke pneumatic actuator
- Torque output up to 4,400 Nm (3,245 lbf.ft)
- Contained spring module for safety and convenience
- Double-acting and spring-return configurations
- Fail close/fail open
- For on/off and modulating
- Valve mounting dimensions per ISO 5211/DIN 3337
- Certified to ATEX 2014/34/EU
- Certified to PED 2014/68/EU
- Suitable for use at SIL3 as a single device in accordance with IEC 61508
- Optional emergency manual override suitable to operate the actuator in the event of fluid supply failure

Skilmatic SI range



Electro-hydraulic actuators

- 1-phase, 3-phase or 24 VDC power supply
- Linear output up to 5,500 kN (1,236,000 lbf)
- Part-turn output up to 500,000 Nm (368,781 lbf.ft)
- Configurable Partial Stroke Testing (PST)
- Failsafe to close, open or lock in last position
- Spring-return or double-acting
- Configurable via *Bluetooth*[®]
- Data logger, recording up to 3,000 events
- Watertight and explosionproof according ATEX, IEC and EAC, TÜV Functional Safety SIL certified to IEC 61508:2010
- Operating temperature -50 °C to +70 °C (-58 to +158 °F)
- Network options *Pakscan*[™], Profibus[®], Modbus[®], HART[®] and Foundation Fieldbus[®]
- Positioning control option 4-20 mA input and output, resolution 0.3%

rotork® Site Services

Rotork Site Services provide our customers with the extensive onsite technical expertise required to ensure the successful functioning of installations anywhere around the globe.

We provide a comprehensive selection of programs around the topic Flow Control:

- Emergency service and scheduled service
- Actuator overhauls
- Status checks
- Preventive maintenance
- Installation of actuators on existing valves
- Plant shutdowns
- Certified inspection and safety checks
- Factory assembly of actuators to new valves
- Plant optimization
- Repairs and upgrades
- Rental service of actuators
- System automation projects
- Advanced automation projects

„In each of our business areas our Site Services Team is dedicated to customer service and support from the commissioning of new installations and supporting customised automated processes to implementing retrofit packages. The teams are available in service centers worldwide and are supplemented by factory-trained specialists“.



High Plant Availability through Preventative Maintenance

Rotork actuators are recognised as the best in the world for reliability and safety in the most demanding applications. To maintain this hard-earned leadership position, Rotork is committed to helping clients to maximise the continuous, fault-free operation and working life of all their actuators.

Rotork have over 60 years of flow control experience with expertise in all actuation applications. Let Rotork leverage this expertise during your planned maintenance periods to maximise operating efficiency of your site while reducing shutdown duration and frequency.

"Rotork actuators incorporate intelligence to satisfy the increasing requirements of actuation, now and in the future. Intelligent Asset Management makes it is easy to identify potential issues, plan predictive maintenance and improve your operating processes".



Damper Actuation Focused



Switch boxes and position indicators



Electric actuators with or w/o spring return

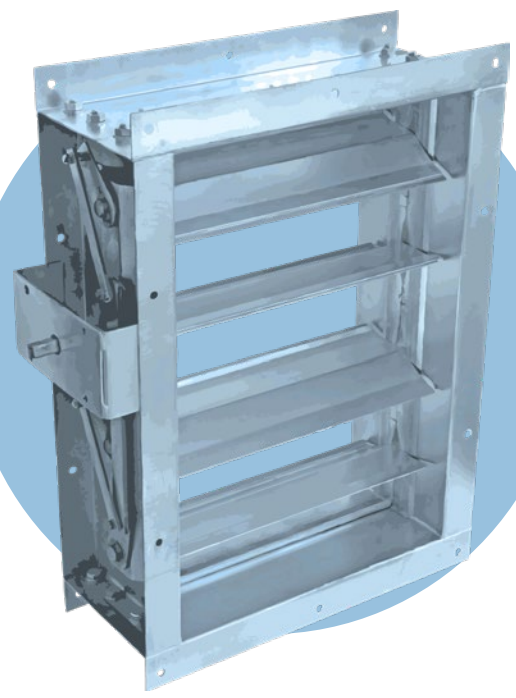

Temperature triggers for fire-dampers



Manual operators



One Air-Damper – Various Actuator Solutions!



Pneumatic control components and air preparation



Pneumatic actuators such as rack and pinion, scotch/yoke, vane, electro-hydraulic



Spring assembly

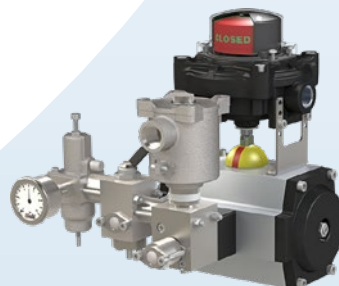

Positioners

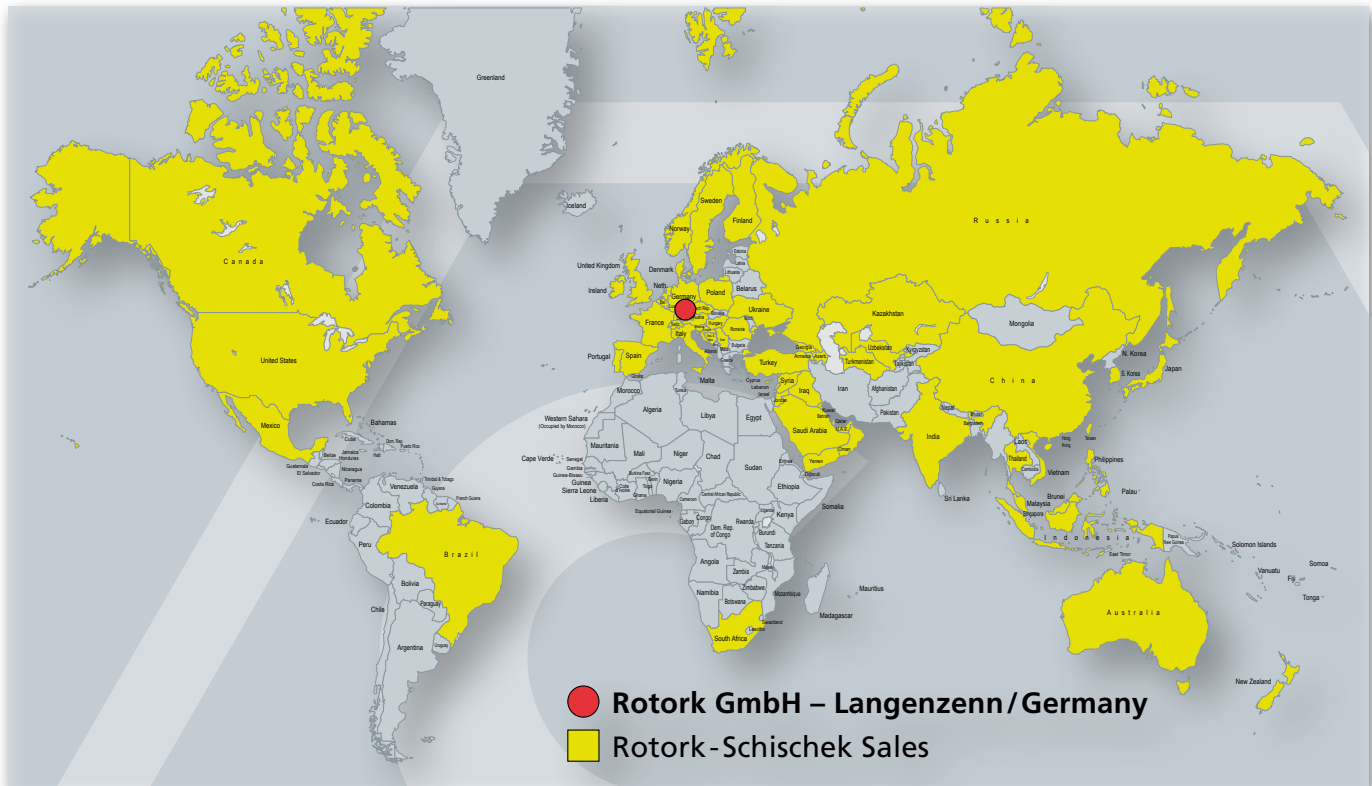

Rotork
hvac@rotork.com
+49 9101 9081-15

Rotork-Schischek Sales Worldwide**Contact Rotork Germany**

Rotork GmbH
Muehlsteig 45
Gewerbegebiet Sued 5
90579 Langenzenn
Germany
Phone +49 9101 9081-0
Fax +49 9101 9081-77
info@schischek.com
www.schischek.com

**Your Local Contact**

To Find Your Local Contact Please Visit:
www.schischek.com/contact/rotork-schischek-worldwide
www.rotork.com/en/contact-us/sales-service-locator

