

TITLE: MULTI-TURN CK ACTUATORS WITH CENTRONIK UNIT AND AID MODULE. OVERALL DIMENSIONS
MODELS: CKC30, CKC60, CKRC30, CKRC60

Rotork Controls. All rights reserved. Subject to change without notice. Previous data sheets invalid with the issue of the latest data sheets. Due to production tolerance variation, the electrical values shown are averages compiled from Actuator production test data. Values are therefore provided for guidance only. Individual production tests are available on request (nominal load not included). Rotork Controls underwrite rated torque output only (specified tolerance -0/+10%)

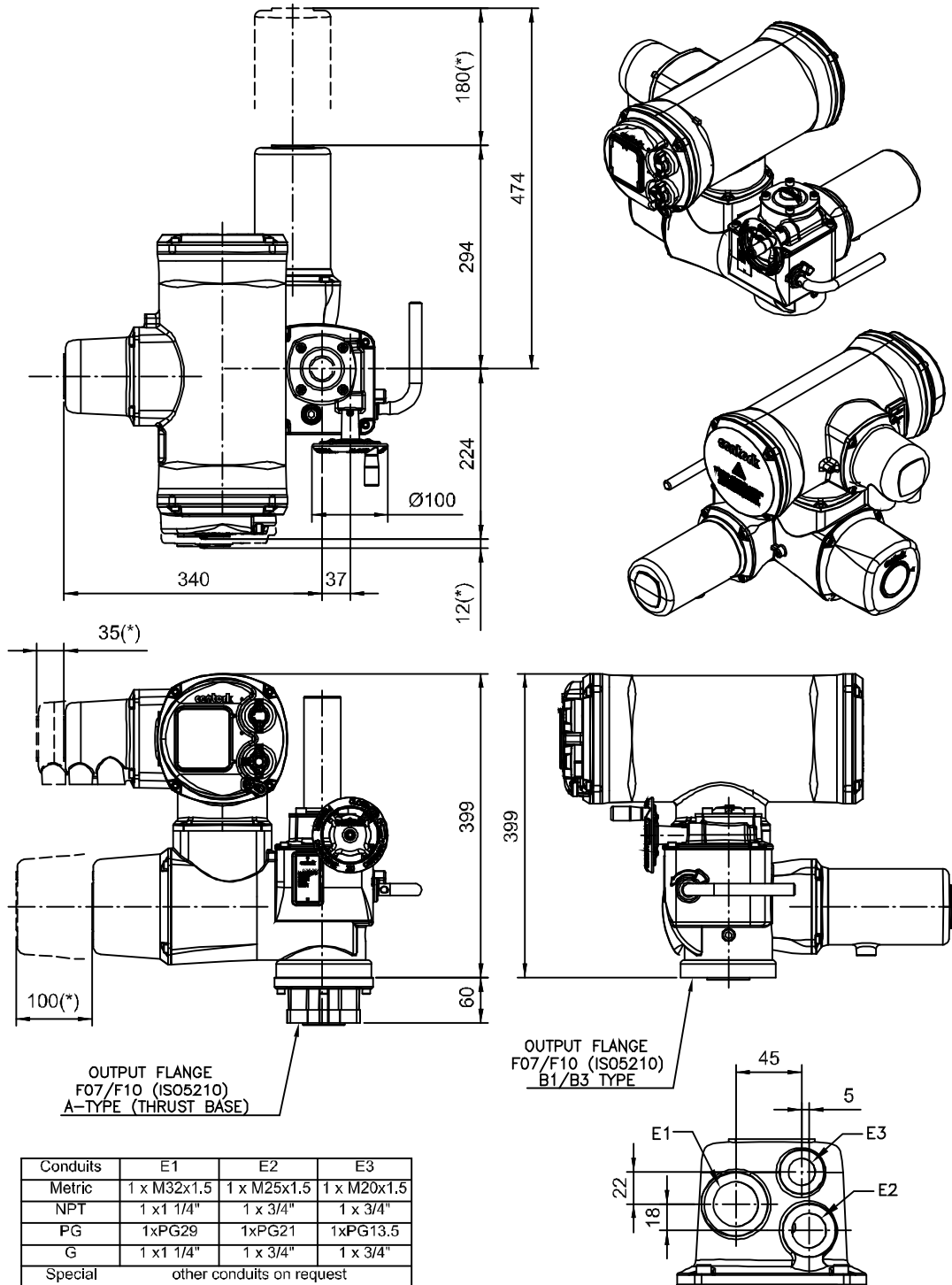

NOTES:

Dimensions, in millimeters

Motor length depends on motor size.

Actuator base according to ISO5210 or MSS SP-102 (optional), B1-type. Thrust base (A type) optional. For base and output dimensions, see E.CK00035 technical datasheet. Actuator weight, see technical datasheets.

Extended cover (AID module), when optional elements of the switch mechanism (or DSM) are selected: Potentiometer, CTP electronic current transmitter, intermediate position switches, or visual indication disc.

(*) Removal allowance distance required.