

rotork[®]

Keeping the World Flowing

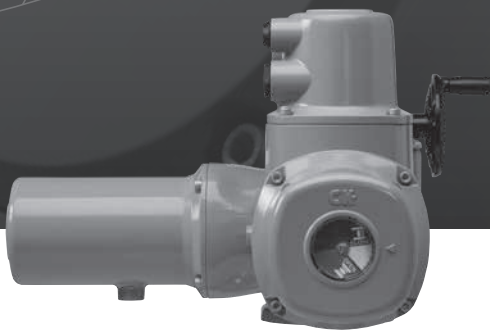

CK Range CK Standard & CK_R - Start Up Guide

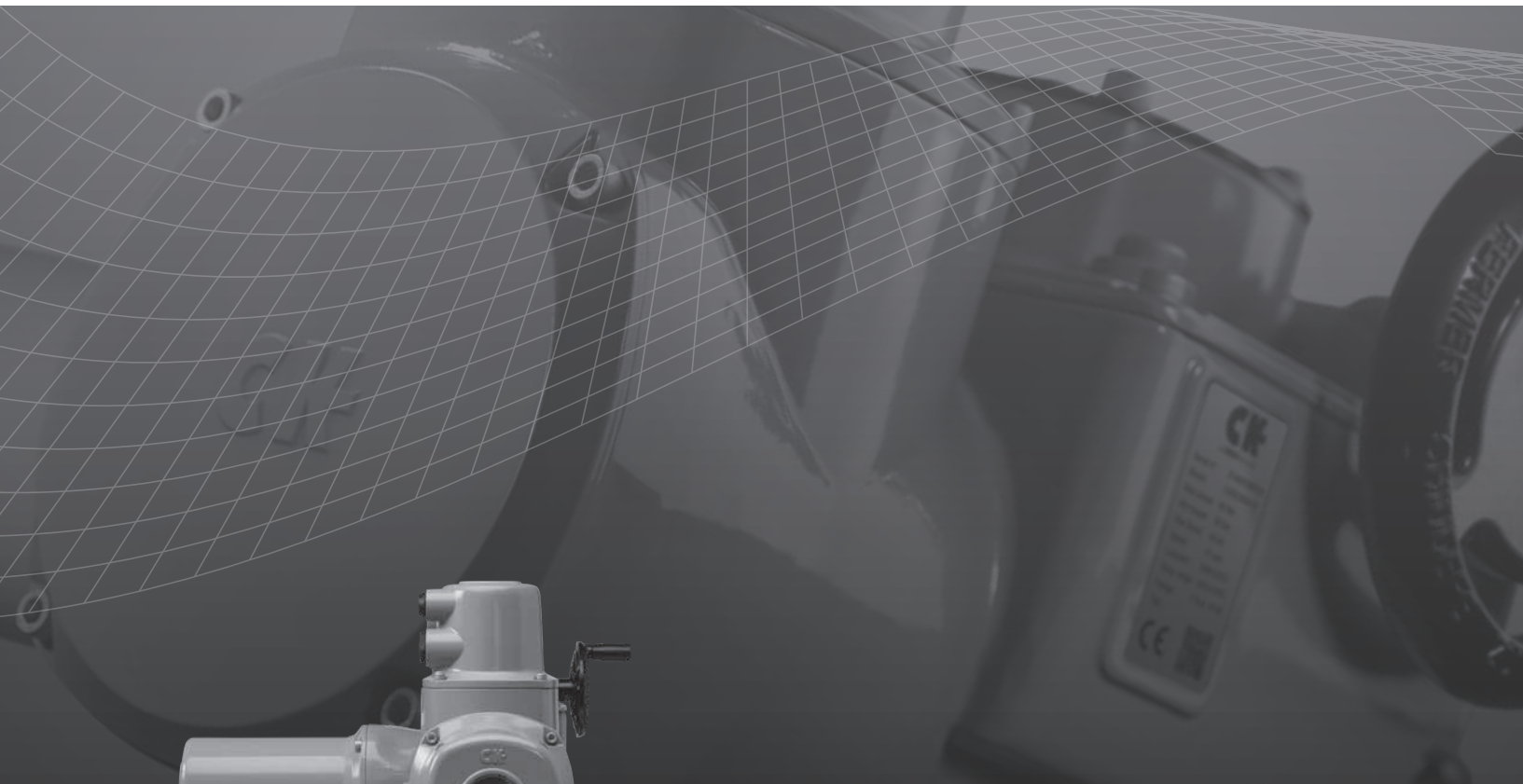

Modular Design Electric Valve Actuators

Contents

Section	Page	Section	Page
CK – Valve Actuation	2	CK Additional Indication Drive – Switch Testing	8
CK Mechanical Switch Mechanism – Switch Testing	3	Test feedback switches	8
Test feedback switches	3	CK Additional Indication Drive – Basic Settings	10
CK Mechanical Switch Mechanism – Basic Settings	5	Set Torque Limits	10
Set Torque Limits	5	Set Position Limits	10
Set Position Limits	6	Setting Local Position Disc	12
		Setting Intermediate Switches	14
		Setting the POT	15
		Setting the CPT	16

CK – Valve Actuation

CK actuators have been developed with over 20 years of experience in actuation solutions. Our valve actuation products range from standard mechanical actuators to advanced digital actuators with integral controls.

Rotork has an extensive product range catering for all industries. Our actuation solutions deliver state-of-the-art performance, value and reliability to the global valve industry. We can help you through the process of product selection and specification from the installation of a single actuator up to complex system integration.

With an international network of offices and distributors we can fully support customer and end user requirements. Over 1,000 service technicians are employed by our company, partners and representatives, providing the necessary worldwide infrastructure to fully support actuators in the field.

Worldwide coverage

Our extensive international network enables us to think globally and act locally when it comes to supporting our customers. Rotork provides an efficient sales service, after sales commissioning and maintenance support throughout the life of the actuator.

Global manufacturing

Product reliability and integrity are priorities in CK product development. Our quality control teams source components from suppliers throughout the world to ensure our customers always receive first class actuation solutions.

Customer support

Rotork provide service support solutions to maximise your productivity and reduce your operational risk.

Information about this manual

The information and instructions included in this manual are applicable for all CK Standard and CK_R actuators. For information or instructions on other CK Range actuators please visit www.rotork.com

CK range



CK Mechanical Switch Mechanism – Switch Testing

Before following any of the setting instructions included in this document it is important to pay attention to the warnings and safety instructions included in PUB111-007 provided with the actuator.

A 5mm Allen (Hex.) key and 1.0 x 5.5mm flat screwdriver are required to perform testing of the CK Mechanical Switch Mechanism.

Test feedback switches

⚠ WARNING: Isolate the main power supply and all control and indication wiring before removing the Plug & Socket cover.

- 1) Undo the four retaining cap screws on the switch mechanism cover and remove the cover to show the switch mechanism.
- 2) Confirm the torque or limit switches are functional by measuring the relevant feedback terminals on the plug assembly (see below).

It is not possible to test a switch that is already actuated by the mechanism (for instance, at the end of travel limits). To ensure that all switches can be tested correctly, move the actuator to a mid-travel position and confirm that none of the switches are active before beginning the test procedure.

- 3) Test position switches in both directions using a flat screwdriver to turn LS TEST (CW for open, ACW for close).
- 4) Link a continuity meter across the following pairs of terminals to test each individual function.

N/C CLS – Normally Closed (break when active) Close Limit contact for motor control

N/O CLS – Normally Open (make when active) Close Limit contact for feedback indication

N/C OLS – Normally Closed (break when active) Open Limit contact for motor control

N/O OLS – Normally Open (make when active) Open Limit contact for feedback indication

⚠ INFO: It is important to recognise the rotation of the exposed plug when performing actuator function diagnostics. The central “U” locating point provides an orientation reference for this testing procedure.

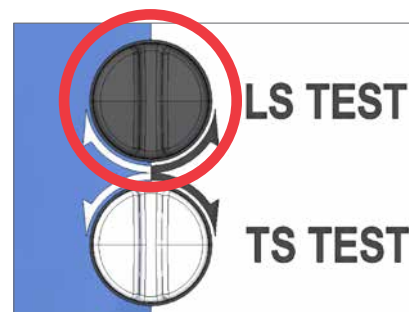
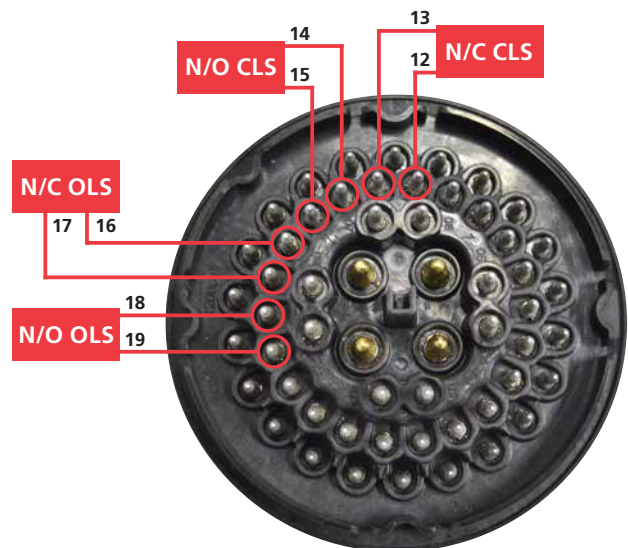
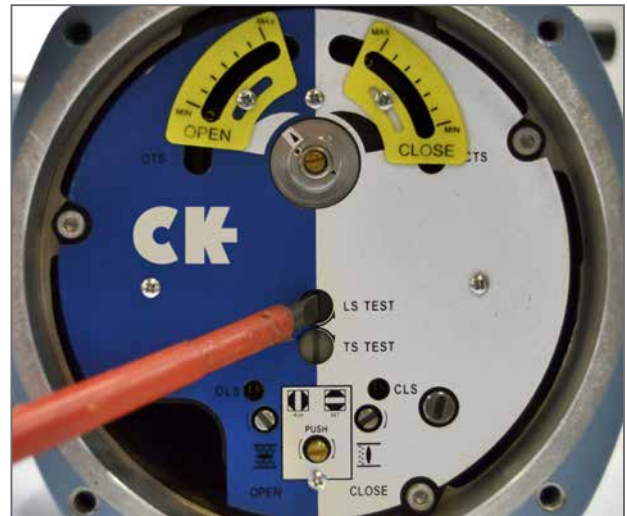

CK Mechanical Switch Mechanism – Switch Testing

Test feedback switches (cont.)

- 5) Test torque switches in both directions using a flat screwdriver to turn TS TEST (ACW for open, CW for close).
- 6) Link a continuity meter across the following pairs of terminals to test each individual function.



- N/C CTS** – Normally Closed (break when active) Close Torque contact for motor control
- N/O CTS** – Normally Open (make when active) Close Torque contact for feedback indication
- N/C OTS** – Normally Closed (break when active) Open Torque contact for motor control
- N/O OTS** – Normally Open (make when active) Open Torque contact for feedback indication

⚠ INFO: It is important to recognise the rotation of the exposed plug when performing actuator function diagnostics. The central "U" locating point provides an orientation reference for this testing procedure.

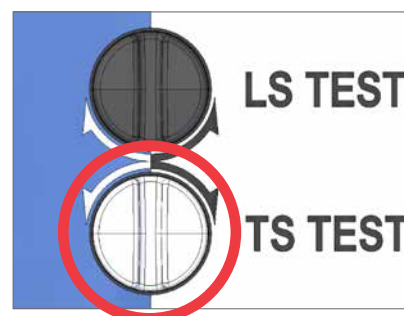
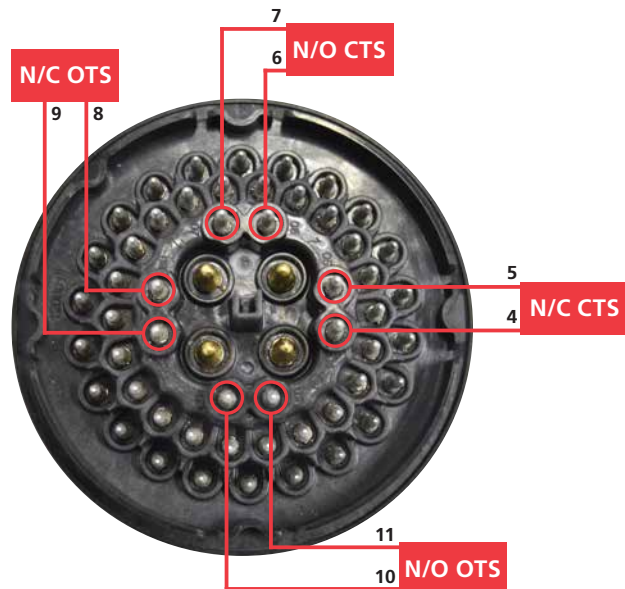

CK Mechanical Switch Mechanism – Basic Settings

A 5mm Allen (Hex.) key and 0.8 x 4mm flat screwdriver are required to perform commissioning of the CK Mechanical Switch Mechanism.

INFO: For CK Standard and CK_R actuators, the required end of travel action (torque or position) is determined by the set of switches cabled to the controlling switch gear - refer to actuator terminal plan and site field wiring.

Set Torque Limits

- A Indicator/Adjustment Point
- B Torque Cam Clutch Screw
- C Open Torque Adjustment Point
- D Close Torque Adjustment Point
- E Factory Calibration Fixings

WARNING: Do not adjust the fixings or position of the yellow torque indicator plates. These are factory configured and should not be removed under any circumstance.

- 1) Move the valve to a mid-travel position and loosen the Torque Cam Clutch Screw 1.5 turns using a flat screwdriver.
- 2) Adjust each Torque Cam to the desired value - between min. (40%) & max. (100%) - by moving the cam using a screwdriver on the adjustment point.

CAUTION: To avoid introducing an offset to the set value when adjusting the torque trip limits. Ensure the screwdriver remains perpendicular to the switch mechanism faceplate.

- 3) Tighten the Torque Cam Clutch Screw once both torque trip limits have been set.

CAUTION: Tighten the Torque Cam Clutch Screw until the spring washer is fully deformed under the screw head.

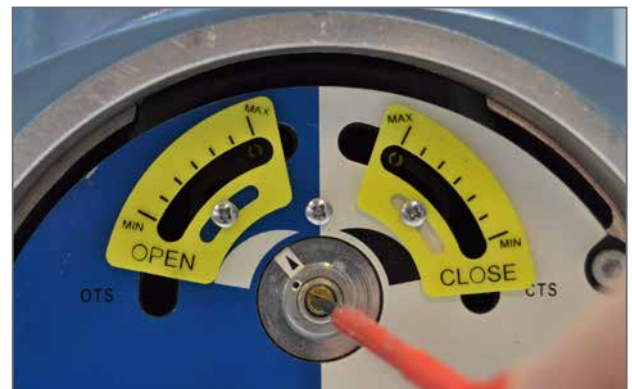
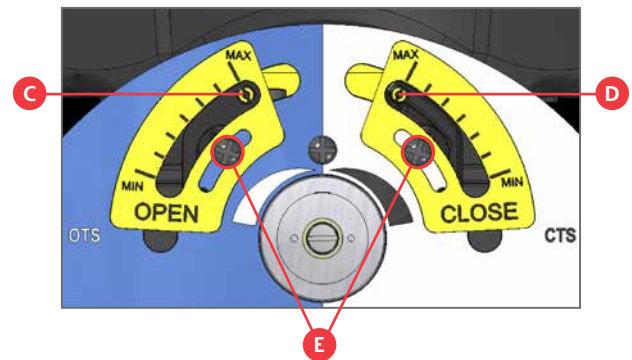
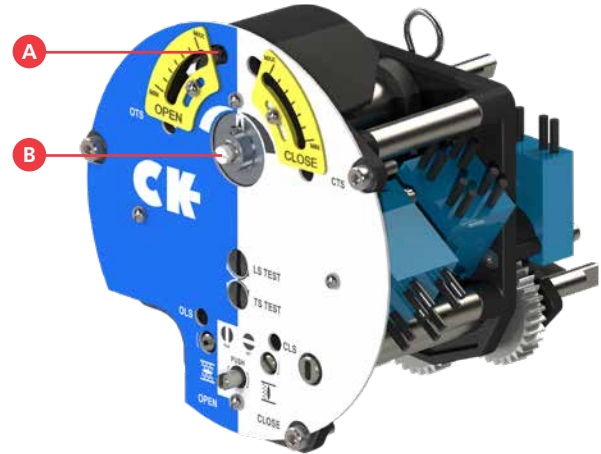

CK Mechanical Switch Mechanism – Basic Settings

Set Position Limits

- F OLS Indicator Window
- G OLS Adjustment Screw
- H Drive Clutch Shaft
- I CLS Indicator Window
- J CLS Adjustment Screw

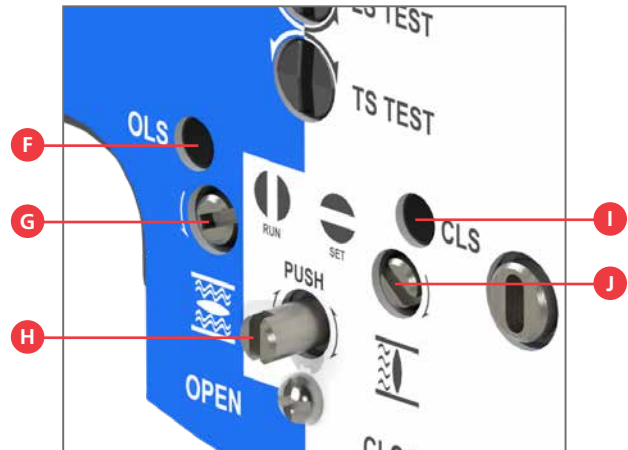

- 1) Move the actuator to the valve CLOSED position using the handwheel.
- 2) Using a flat screwdriver, depress the Drive Clutch Shaft and rotate to the "Set" position as shown on the switch mechanism faceplate.
- 3) The CLS Adjustment Screw must now be rotated to engage the closed limit switch inside the switch mechanism. The CLS Indicator Window will show one of four possible symbols. Please refer to Figure 1 on page 7 for direction input.
- 4) Depending on where the mechanism is in the cycle, it is possible that the switch will be approached from the wrong direction, in this case it is necessary to move through the limit and approach it from the correct direction. This avoids the need to wind through the whole mechanism to reach the limit position. The correct direction to approach the limit is shown by the arrow next to the Adjustment Screw input.
- 5) Perform two checks to confirm the CLOSED limit position switch has been engaged correctly.
 - a. The feel of the Adjustment Screw will noticeably change providing more mechanical resistance at the switching point of the contact.
 - b. Use a continuity meter on the appropriate terminals – 12 & 13 for motor control and 14 & 15 for indication feedback to check the switch is engaged.
- 6) Using a flat screwdriver, depress the Drive Clutch Shaft and rotate to the "Run" position as shown on the switch mechanism faceplate.
- 7) Rotate the CLS and OLS Adjustment Screws a small amount in both directions to re-engage the mechanism drive. A click will be heard as the drive drops back into engagement and the adjustment screws will no longer move in either direction.

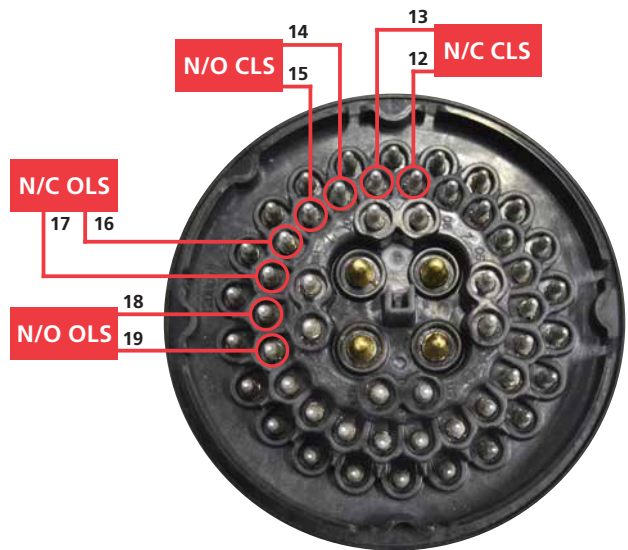
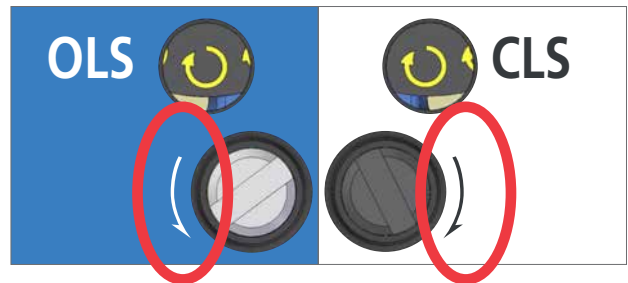

N/C CLS – Normally Closed (break when active) Close Limit contact for motor control

N/O CLS – Normally Open (make when active) Close Limit contact for feedback indication

N/C OLS – Normally Closed (break when active) Open Limit contact for motor control

N/O OLS – Normally Open (make when active) Open Limit contact for feedback indication

⚠ CAUTION: This must be done or the limit will be lost when the actuator is moved.

CK Mechanical Switch Mechanism – Basic Settings

- 8) Move the actuator to the valve OPEN position using the handwheel.
- 9) Using a flat screwdriver, depress the Drive Clutch Shaft and rotate to the "Set" position as shown on the switch mechanism faceplate.
- 10) The OLS Adjustment Screw must now be rotated to engage the open limit switch inside the switch mechanism. The OLS Indicator Window will show one of four possible symbols. Please refer to Figure 1 below for direction input.
- 11) Depending on where the mechanism is in the cycle, it is possible that the switch will be approached from the wrong direction, in this case it is necessary to move through the limit and approach it from the correct direction. This avoids the need to wind through the whole mechanism to reach the limit position. The correct direction to approach the limit is shown by the arrow next to the Adjustment Screw input.
- 12) Perform two checks to confirm the OPEN limit position switch has been engaged correctly.
 - a. The feel of the Adjustment Screw will noticeably change providing more mechanical resistance at the switching point of the contact.
 - b. Use a continuity meter on the appropriate terminals – 16 & 17 for motor control and 18 & 19 for indication feedback to check the switch is engaged correctly.
- 13) Using a flat screwdriver, depress the Drive Clutch Shaft and rotate to the "Run" position as shown on the switch mechanism faceplate.
- 14) Rotate the OLS and CLS Adjustment Screws a small amount in both directions to re-engage the mechanism drive. A click will be heard as the drive drops back into engagement and the adjustment screws will no longer move in either direction.

⚠ CAUTION: This must be done or the limit will be lost when the actuator is moved.

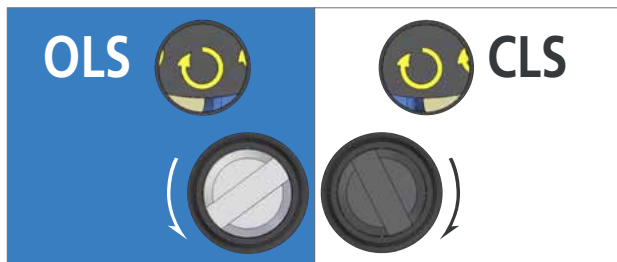
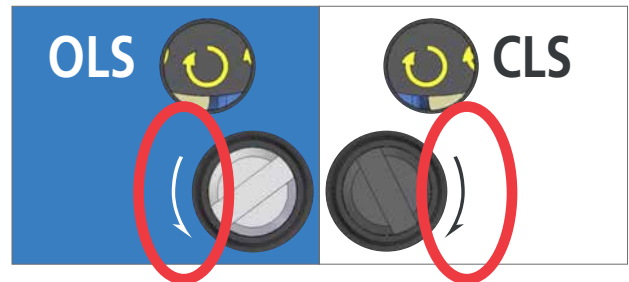

Rotate the OLS/CLS Adjustment Shaft Clockwise.

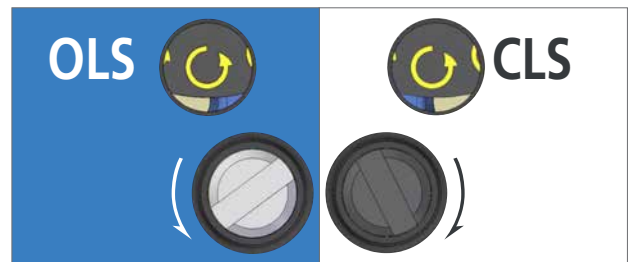

Rotate the OLS/CLS Adjustment Shaft Anti-Clockwise.

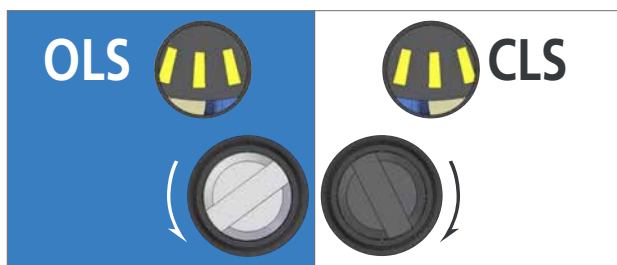

Rotate the OLS/CLS Adjustment Shaft in the direction shown next to the Shaft input.



The limit switching point is near or made.

Figure 1.

CK Additional Indication Drive – Switch Testing

Test feedback switches

⚠ WARNING: Isolate the main power supply to the actuator and remove the Plug & Socket cover.

- 1) Undo the four retaining cap screws on the switch mechanism cover and remove the cover to show the switch mechanism.
- 2) Confirm the torque or limit switches are functional by measuring the relevant feedback terminals on the plug assembly (see below).

It is not possible to test a switch that is already actuated by the mechanism (for instance, at the end of travel limits). To ensure that all switches can be tested correctly, move the actuator to a mid-travel position and confirm that none of the switches are active before beginning the test procedure.

- 3) Test the position switches in both directions using the LS TEST lever shown on the right hand side of the unit between the AID module and the Mechanical Switch Mechanism (move DOWN for open, UP for close).
- 4) Use a continuity meter across the following pairs of terminals to test each individual function.

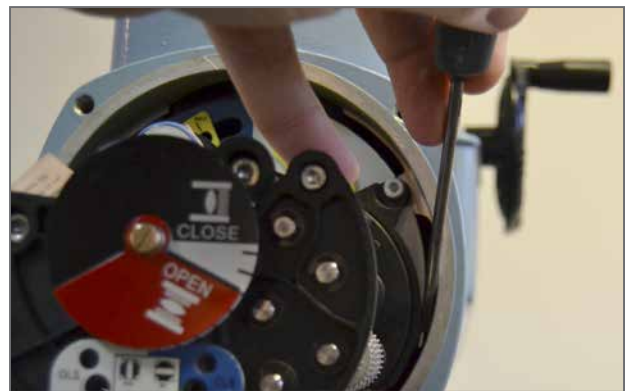
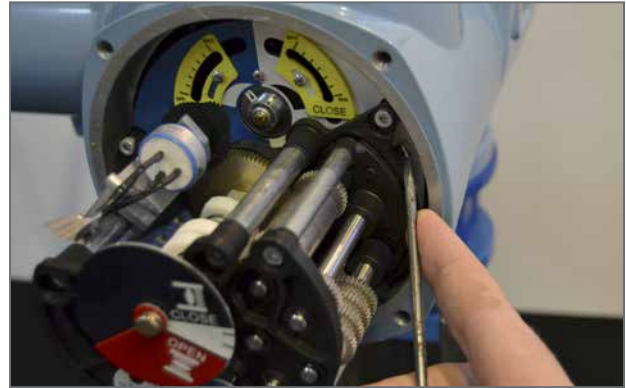
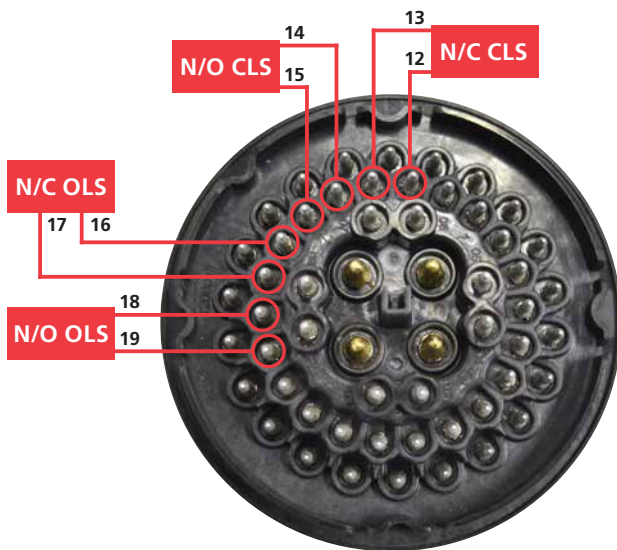

N/C CLS – Normally Closed (break when active) Close Limit contact for motor control

N/O CLS – Normally Open (make when active) Close Limit contact for feedback indication

N/C OLS – Normally Closed (break when active) Open Limit contact for motor control

N/O OLS – Normally Open (make when active) Open Limit contact for feedback indication

⚠ INFO: It is important to recognise the rotation of the exposed plug when performing actuator function diagnostics. The central "U" locating point provides an orientation reference for this testing procedure.

CK Additional Indication Drive – Switch Testing

Test feedback switches (cont.)

- 5) Test the torque switches in both directions using the TS TEST lever shown on the left hand side of the unit between the AID module and Mechanical Switch Mechanism (move DOWN for open, UP for close).
- 6) Use a continuity meter across the following pairs of terminals to test each individual function.

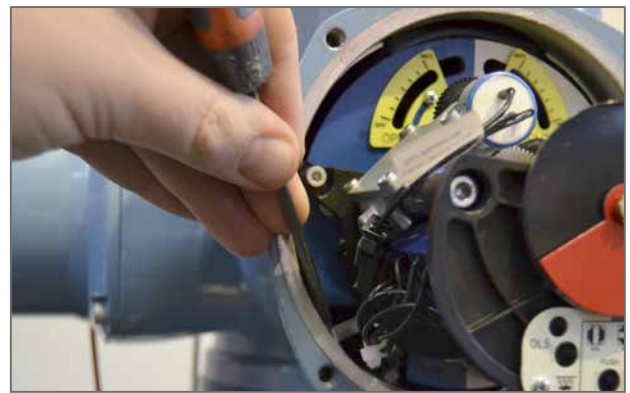
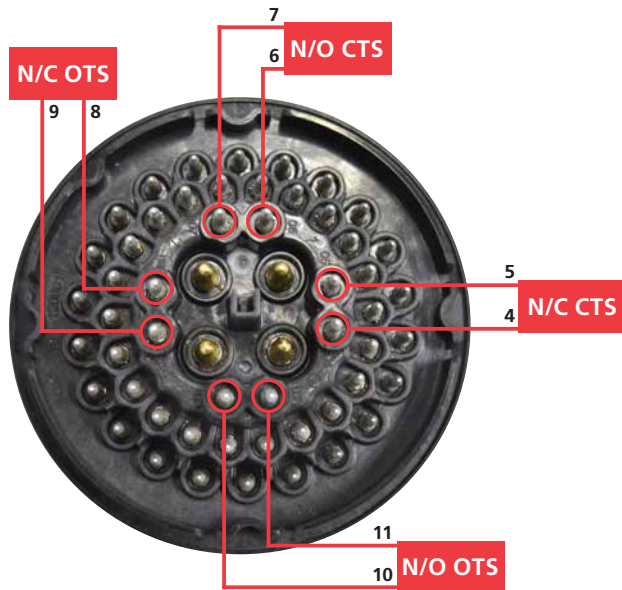

N/C CTS – Normally Closed (break when active) Close Torque contact for motor control

N/O CTS – Normally Open (make when active) Close Torque contact for feedback indication

N/C OTS – Normally Closed (break when active) Open Torque contact for motor control

N/O OTS – Normally Open (make when active) Open Torque contact for feedback indication

⚠ INFO: It is important to recognise the rotation of the exposed plug when performing actuator function diagnostics. The central "U" locating point provides an orientation reference for this testing procedure.

CK Additional Indication Drive – Basic Settings

A 5mm Allen (Hex.) key and 0.8 x 4mm flat screwdriver with at least 120mm shaft length are required to perform commissioning of the CK Mechanical Switch Mechanism. A small torch may be required in environments with low level lighting.

Set Torque Limits

The torque limits can be set using the same method previously described in this manual at the beginning of the Basic Settings section. Access to the torque setting inputs is maintained whilst the AID module is fitted.

Set Position Limits

The position limits can still be set with the CK AID module in place. The OLS/CLS Indicator windows and adjustment screws can be accessed through the labelled holes in the AID chassis.

⚠ CAUTION: It is important to remove the POT drive assembly (if fitted) from the drive gearing prior to setting the position limits. Refer to Setting the POT section, steps 1 and 2 for instructions on adjusting this component.

- 1) Move the actuator to the valve CLOSED position using the handwheel.
- 2) Using a flat screwdriver, depress the Drive Clutch Shaft and rotate to the “Set” position as shown on the AID faceplate.
- 3) The CLS Adjustment Screw must now be rotated to engage the closed limit switch inside the switch mechanism. The CLS Indicator Window will show one of four possible symbols. Please refer to Figure 2 on page 11 for direction input.
- 4) Depending on where the mechanism is in the cycle, it is possible that the switch will be approached from the wrong direction, in this case it is necessary to move through the limit and approach it from the correct direction. This avoids the need to wind through the whole mechanism to reach the limit position. The correct direction to approach the limit is shown by the arrow next to the Adjustment Screw input.
- 5) Perform two checks to confirm the CLOSED limit position switch has been made correctly.
 - a. The feel of the Adjustment Screw will noticeably change providing more mechanical resistance at the switching point of the contact.
 - b. Use a continuity meter on the appropriate terminals – 12 & 13 for motor control and 14 & 15 for indication feedback to check the switch is engaged.
- 6) Using a flat screwdriver, depress the Drive Clutch Shaft and rotate to the “Run” position as shown on the AID faceplate.
- 7) Rotate the CLS and OLS Adjustment Screws a small amount in both directions to re-engage the mechanism drive. A click will be heard as the drive drops back into engagement and the adjustment screws will no longer move in either direction.

⚠ CAUTION: This must be done or the limit will be lost when the actuator is moved.

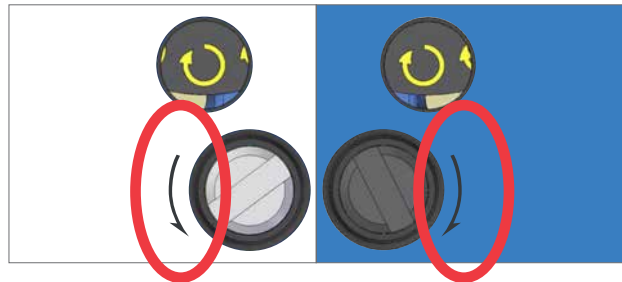
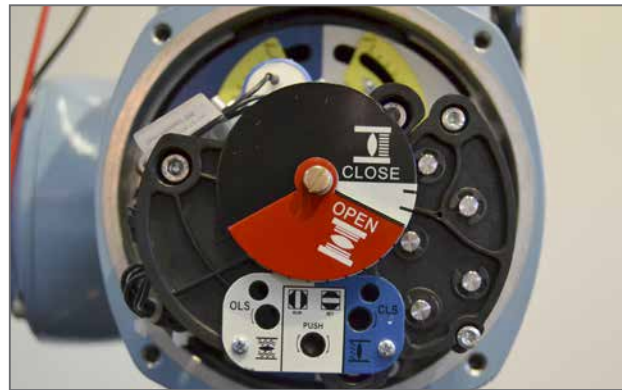

CK Additional Indication Drive – Basic Settings

- 8) Move the actuator to the valve OPEN position using the handwheel.
- 9) Using a flat screwdriver, depress the Drive Clutch Shaft and rotate to the "Set" position as shown on the AID faceplate.
- 10) The OLS Adjustment Screw must now be rotated to engage the open limit switch inside the switch mechanism. The OLS Indicator Window will show one of four possible symbols. Please refer to Figure 2 for direction input.
- 11) Depending on where the mechanism is in the cycle, it is possible that the switch will be approached from the wrong direction, in this case it is necessary to move through the limit and approach it from the correct direction. This avoids the need to wind through the whole mechanism to reach the limit position. The correct direction to approach the limit is shown by the arrow next to the Adjustment Screw input.
- 12) Perform two checks to confirm the OPEN limit position switch has been made correctly.
 - a. The feel of the Adjustment Screw will noticeably change providing more mechanical resistance at the switching point of the contact.
 - b. Use a continuity meter on the appropriate terminals – 16 & 17 for motor control and 18 & 19 for indication feedback to check the switch is engaged.
- 13) Using a flat screwdriver, depress the Drive Clutch Shaft and rotate to the "Run" position as shown on the AID faceplate.
- 14) Rotate the OLS and CLS Adjustment Screws a small amount in both directions to re-engage the mechanism drive. A click will be heard as the drive drops back into engagement and the adjustment screws will no longer move in either direction.

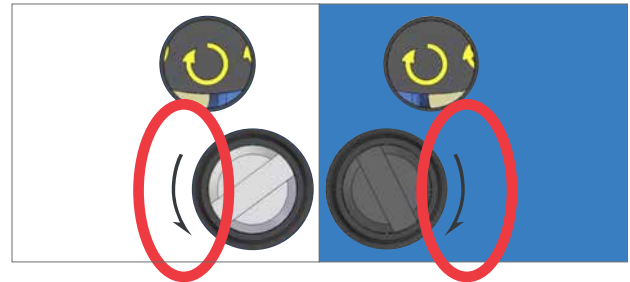

⚠ CAUTION: This must be done or the limit will be lost when the actuator is moved.

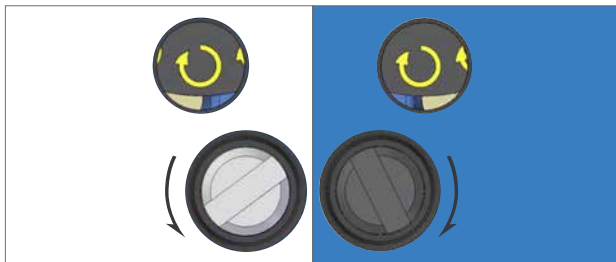

Rotate the OLS/CLS Adjustment Shaft Clockwise.

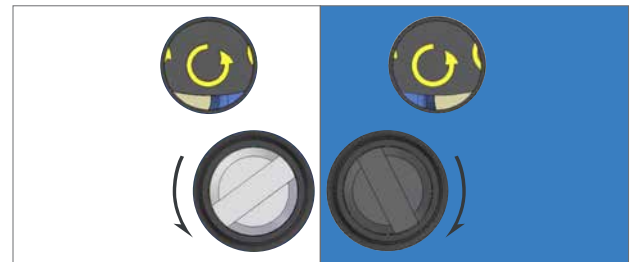

Rotate the OLS/CLS Adjustment Shaft Anti-Clockwise.

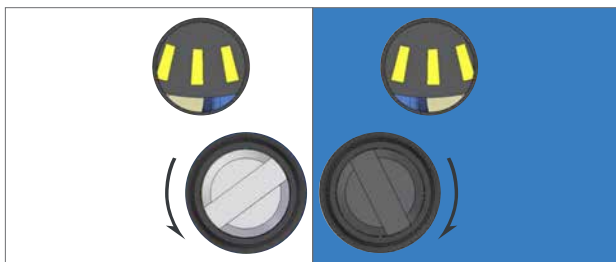

Rotate the OLS/CLS Adjustment Shaft in the direction shown next to the Shaft input.

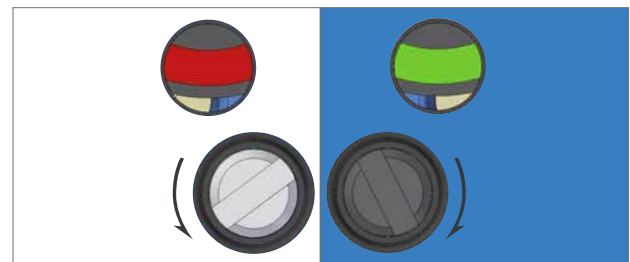

The limit switching point is near or made.

Figure 2.

CK Additional Indication Drive – Basic Settings

Setting Local Position Disc

The AID module includes a Local Position Disc that should be configured to show Open and Close limit positions. A series of reduction gears ensure a suitable range of travel can be accommodated. If more turns are required please contact Rotork.

⚠ CAUTION: The actuator position limits must be configured prior to setting the Local Position Disc.

⚠ CAUTION: The AID cover orientation can be adjusted through 360° in 90° increments. If this is a requirement then the following instructions must be adjusted by the same increment in the same direction.

- 1) Move the actuator to the CLOSED limit using electrical operation or the handwheel.
- 2) Loosen off the Position Disc Retaining Screw by 1 turn.
- 3) Rotate the Position Disc so that CLOSE reads horizontally and hold the disc in place.
- 4) Tighten the Position Disc Retaining Screw until the Position Disc is firmly locked in place.
- 5) Confirm the CLOSE label is aligned correctly with the cover indication arrow.

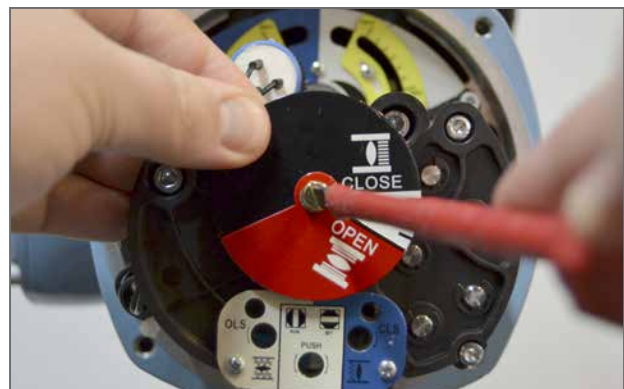
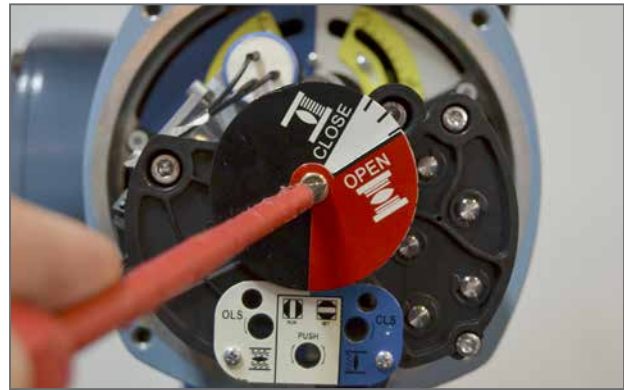

CK Additional Indication Drive – Basic Settings

- 6) Move the actuator to the OPEN limit using electrical or operation or the handwheel.



- 7) Loosen off the Position Disc Retaining Screw by 1 turn whilst holding the CLOSE portion of the Position Disc.

- 8) Rotate only the red OPEN portion of the disc so that OPEN reads horizontally and then hold both portions in place.



- 9) Tighten the retaining screw until the Position Disc is firmly locked in place.

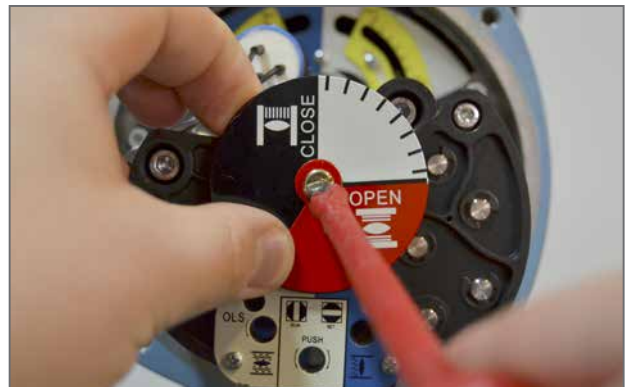

- 10) Confirm the OPEN label is aligned correctly with the cover indication arrow.



CK Additional Indication Drive – Basic Settings

Setting Intermediate Switches

The AID Module can include four additional switches to indicate configurable intermediate positions.

⚠ CAUTION: The actuator position limits must be configured prior to setting the Intermediate Switches.

- 1) Move the actuator to the desired intermediate position using electrical operation or the handwheel.
- 2) Move the switch cam along the shaft against the spring to allow free rotation of the cam.
- 3) Rotate the cam to ensure the desired switch behaviour is achieved. The intermediate position switches can be supplied with normally open or normally closed contact form.
- 4) Confirm the switch has been engaged/disengaged by measuring continuity across the relevant terminals during cam adjustment – refer to actuator wiring diagram and pictorial annotations (right) for the relevant switch information.
- 5) Repeat steps 1 to 4 for each intermediate position switch.

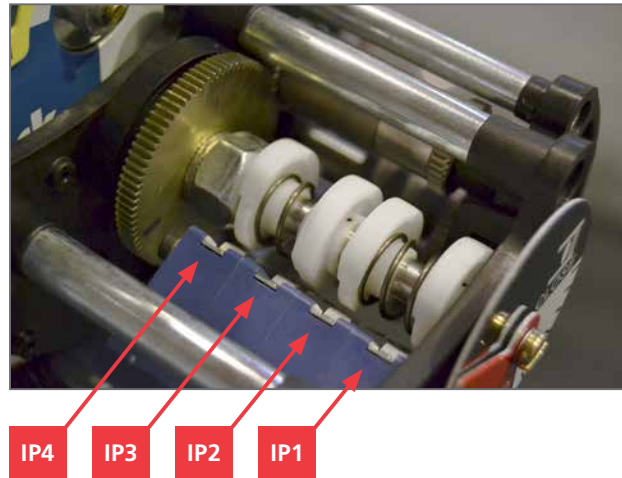

CK Additional Indication Drive – Basic Settings

Setting the POT

The AID Module can include a potentiometer for remote position feedback. This can provide a potentiometric output or a 4-20 mA scaled position output via the Current Position Transmitter option (refer to next page).

The POT drive includes four different sized gears that allow the single turn POT to be scaled according to the total valve travel. For information on which ratio is suitable for your application please contact Rotork.

⚠ CAUTION: The actuator position limits must be configured prior to setting the AID POT drive.

- 1) Loosen off the retaining grub screw using a 1.5mm Allen (Hex.) Key.
- 2) Rotate the POT drive assembly away from the driving gear.
- 3) Move the actuator to the Closed Limit position using electrical operation or the handwheel.
- 4) Connect a test meter across the POT terminals* – refer to actuator wiring diagram and POT Setting Information table below.
- 5) Rotate the POT input gears until the required resistance value has been reached.
- 6) Refit the POT assembly to the AID chassis and ensure the teeth mate correctly with the position drive gear.

⚠ CAUTION: Extra care must be taken to ensure the correct POT input gear is mated with the position drive gear.

- 7) Tighten the retaining grub screw to prevent movement of the POT drive assembly.
- 8) Move the actuator to the Open Limit position using electrical operation or the handwheel.
- 9) Confirm the POT is reading the required resistance value.



*Potentiometer terminals may not be accessible if the AID CPT option is also fitted. In this instance it is important to ensure the POT does not slip throughout full valve travel. Current should change through 4-20 mA however tuning may be required. Refer to the next page for tuning instructions.

POT Setting Information			
Travel Direction	Value at Closed Limit	Value at Open Limit	Measurement Terminals
Clockwise	Low	High	30 & 31
Clockwise	High	Low	31 & 32
Anti-Clockwise	Low	High	31 & 32
Anti-Clockwise	High	Low	30 & 31

CK Additional Indication Drive – Basic Settings

Setting the CPT

Once the POT drive is commissioned for full valve travel, the CPT can be calibrated to output a 4-20 mA loop powered signal. This can be used as direct actuator position feedback to the site control system.

The CPT option includes two different trimming potentiometers to enable zero and span values to be calibrated.

⚠ CAUTION: The actuator position limits and POT drive must be configured prior to setting the AID CPT.

- 1) Run the actuator to the Closed position limit using electrical operation or the handwheel.
- 2) Monitor position feedback using a powered test meter across the CPT terminals – refer to actuator wiring diagram.
- 3) Rotate the ZERO trimming potentiometer so that 4 mA is output from the CPT.
- 4) Run the actuator to the Open position limit using electrical operation or the handwheel.
- 5) Monitor position feedback using a powered test meter across the CPT terminals – refer to actuator wiring diagram.
- 6) Rotate the SPAN trimming potentiometer so that 20 mA is output from the CPT.
- 7) Adjustment of the SPAN will cause the ZERO to change a small amount. It is important to repeat steps 1 to 6 a second time in order to remove this calibration error.

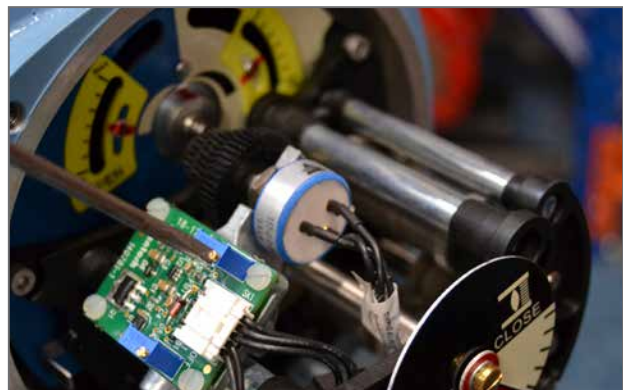
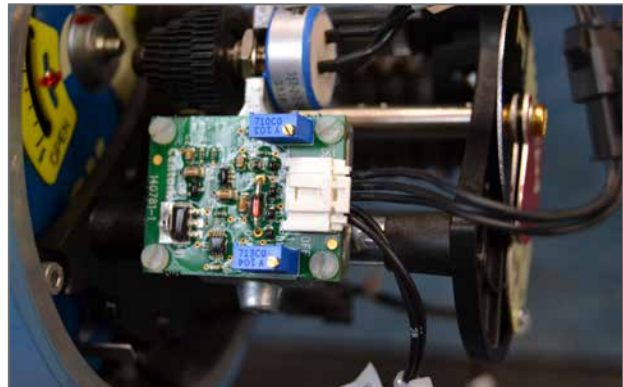

rotork®

Keeping the World Flowing



www.rotork.com

A full listing of our worldwide sales and service network is available on our website.

Rotork plc
Brassmill Lane, Bath, UK
tel +44 (0)1225 733200
fax +44 (0)1225 333467
email mail@rotork.com

Rotork is a corporate member of the Institute of Asset Management



PUB111-003-00
Issue 11/17

As part of a process of on-going product development, Rotork reserves the right to amend and change specifications without prior notice. Published data may be subject to change. For the very latest version release, visit our website at www.rotork.com

The name Rotork is a registered trademark. Rotork recognizes all registered trademarks. Published and produced in the UK by Rotork. POWJB0519