

rotork[®]

Controls

SM-6000 Series

Rotary Actuator
Installation & Maintenance Instructions

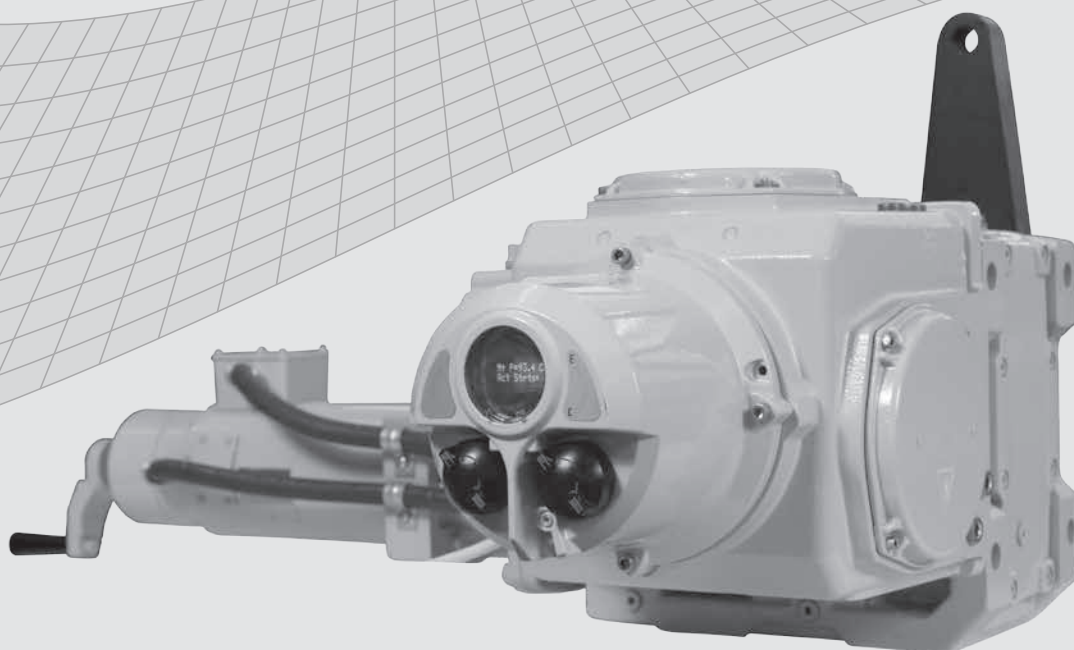

SM-6000 Series
(without local remote switch)
For actuators with local remote switch
see publication PUB052-003

Keeping the World Flowing



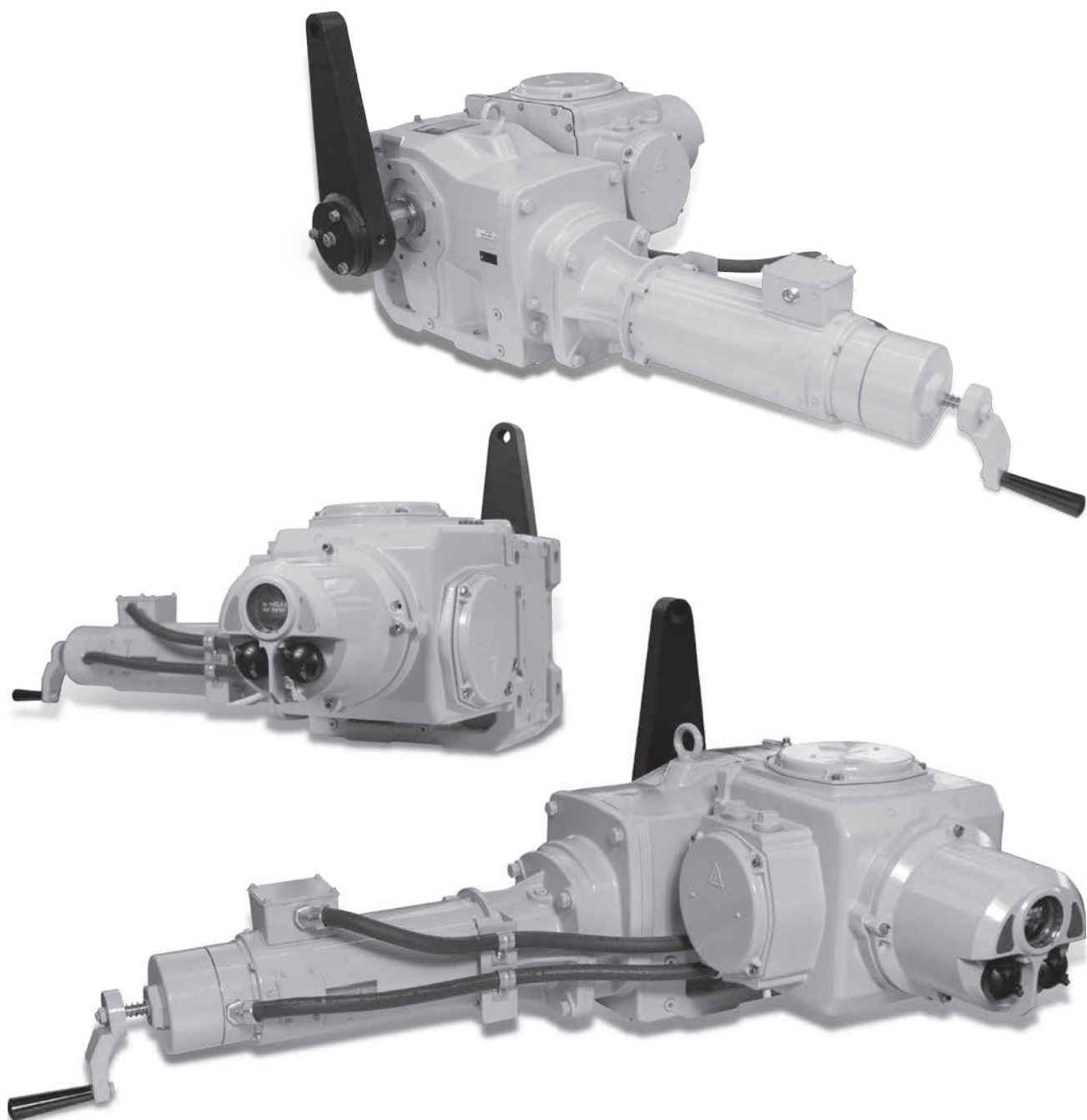
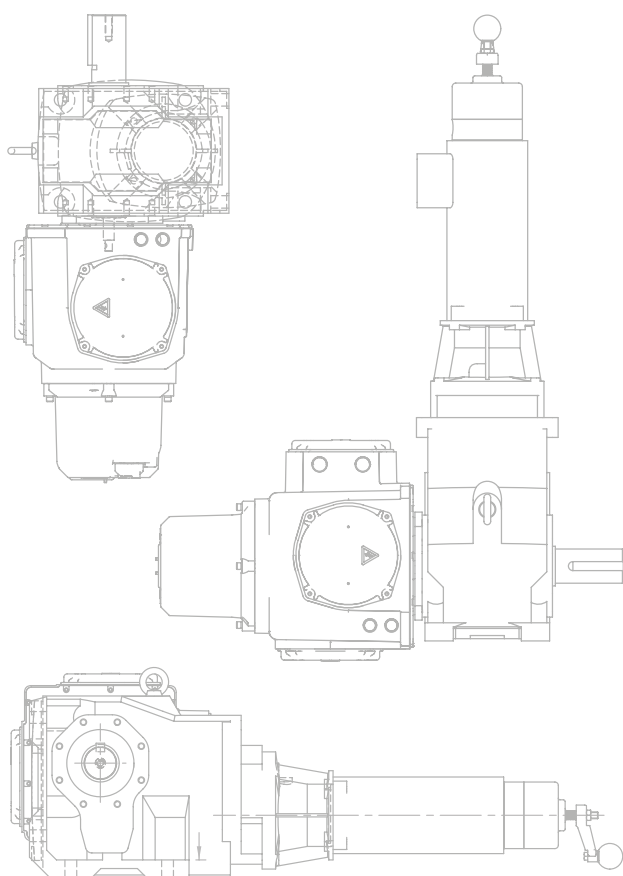

Figure 1.0. SM6000-S2 actuator

Contents



Section	Page
1 General Information	4
2 Specifications	7
2.1 - Optional Equipment	8
3 Installation	9
3.1 - Typical Wiring Diagram	12
3.2 - Microprocessor Based Motor Drive & Controller Setup	13
4 Operating your SM6000	14
4.1 - Status Description	15
4.2 - Start Up	16
4.2.1 - Select Automatic Mode	20
4.3 - Range of Operation - Setup	23
4.3.1 - Range of Operation	23
4.3.2 - Set Zero and SPAN	27
4.3.3 - Setting Limit Switches	32
4.3.4 - Operating Speed	34
5 Setup & Calibration	36
5.1 - Setup & Calibration - Level 1	37
5.1.1 - Max Cmd Cal	38
5.1.2 - Min Cmd Cal	38
5.1.3 - Speed	39
5.1.4 - CmdD Type	39
5.1.5 - LOS Act	39
5.1.6 - LOS Pos	40
5.1.7 - CUR P Gain	40
5.1.8 - CUR I Gain	40
5.1.9 - Min Pos	41
5.1.10 - Max Pos 41	41
5.1.11 - Max Torque %	42
5.1.12 - Save Config	42
5.2 - Communications	43
5.2.1 - HART Control Options	43
5.2.2 - PROFIBUS Control Options	45
5.2.3 - Foundation Fieldbus Control Options	47
5.3 - Setup and Calibration - Level 2	49
6 Faults & Troubleshooting	52
6.1 - Fault Status Indication	52
6.2 - Troubleshooting	53
7 Manual Operation - Handcrank Direction	54
8 Mounting Conversion	55
9 Parts Identification	56
10 Drive Arm Dimensions	59
11 Overall Dimensions	60
12 Linkage Options	61
13 User Settings	62
Notes	63

1 - General Information

Introduction

Rotork Controls designs, manufactures, and tests its products to meet national and International standards. For these products to operate within their normal specifications, they must be properly installed and maintained. The following instructions must be followed and integrated with your safety program when installing, using, and maintaining Rotork Controls products:

Read and save all instructions prior to installing, operating, and servicing this product. If any of the instructions are not understood, contact your Rotork Controls representative for clarification.

Follow all warnings, cautions, and instructions marked on, and supplied with, the product. Inform and educate personnel in the proper installation, operation, and maintenance of the product.

Install equipment as specified in Rotork Controls installation instructions and per applicable local and national codes. Connect all products to the proper electrical sources. To ensure proper performance, use qualified personnel to install, operate, update, tune, and maintain the product.

When replacement parts are required, ensure that the qualified service technician uses replacement parts specified by Rotork Controls. Substitutions may result in fire, electrical shock, other hazards, or improper equipment operation.



WARNING

Before installing the actuator, make sure that it is suitable for the intended application. If you are unsure, consult Rotork Controls prior to proceeding.



WARNING - SHOCK HAZARD

Installation and servicing must be performed only by qualified personnel.



WARNING ELECTROSTATIC DISCHARGE

The Electronic controller is static-sensitive. To protect the internal components from damage caused by static discharge, never touch the printed circuit cards without being statically protected.

RECEIVING /INSPECTION

Carefully inspect for shipping damage. Damage to the shipping carton is usually a good indication that it has received rough handling. Report all damage immediately to the freight carrier and Rotork Controls, Inc. Verify that the items on the packing list or bill of lading agree with your own.

STORAGE

If the actuator will not be installed immediately, it should be stored indoors in a clean, dry area where the ambient temperature is not less than -20° F. The actuator should be stored in a non-corrosive environment. The actuator is not sealed to NEMA 4 until the conduit entries are properly connected.

1 - General Information

EQUIPMENT RETURN

A returned goods authorization (RG) number is required to return any equipment for repair.

This must be obtained from Rotork Controls.
(Telephone: 414/461-9200).

The equipment must be shipped, freight prepaid, to the following address after the RG number is Issued:

Attn: Service Department
Rotork Controls, Inc.
5607 West Douglas Avenue
Milwaukee, Wisconsin 53218

To facilitate quick return and handling of your equipment, include:

RG Number on outside of box
Your Company Name,
Contact Person.
Phone/Fax #
Address
Repair Purchase Order Number
Brief description of the problem.

IDENTIFICATION LABEL

An identification label is attached to each actuator. When ordering parts, requesting information or service assistance, please provide all of the label information. **You must supply the serial number with all enquiries.**

ABBREVIATIONS USED IN THIS MANUAL

A	Ampere
AC	Alternating Current
°C	Degrees Celsius
CW	Clockwise
ACW	Anti-clockwise
CCW	Counter-clockwise
DC	Direct Current
°F	Degrees Fahrenheit
G	Earth Ground
Hz	Hertz
in. lbs	Inch Pounds
kg	Kilogram
L	Line (power supply)
lbs	Pounds Force
LVDT	Linear Variable Differential Transformer
mA	Milliamp
mfd	Microfarad
mm	Millimeters
N	Newton (force)
NEMA	National Electrical Manufacturing Association
Nm	Newton Meter
NPT	National Pipe Thread
PCB	Printed Circuit Board
PH	Phase
PL	Position Limit switch
RPM	Revolutions per Minute
SEC	Second
SPDT	Single Pole Double Throw
TL	Torque Limit Switch
V	Volts
VA	Volt Amps
VAC	Volts AC
VDC	Volts DC
VFD	Vacuum Fluorescent Display
VR	Variable Resistance
W	Watt



Figure 1.1. Actuator identification label.

1 - General Information

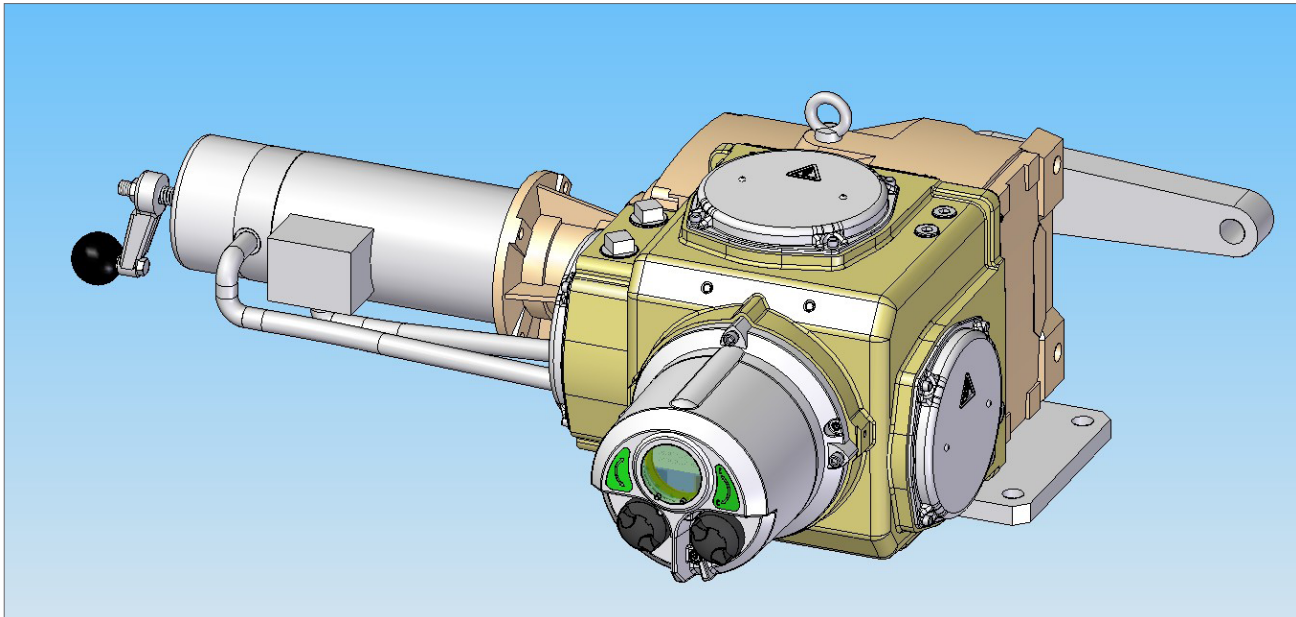

Figure 1.2. 3D rendering of SM6000-S2 actuator.

GENERAL DESCRIPTION, ACTUATOR

The SM-6000 is an AC input, DC driven electric actuator designed for high modulation service. This actuator uses a Rotork Controls locally mounted, or remotely located microprocessor-based motor drive and controller. A wide array of standard options are available for this actuator.

The SM-6000 Series actuators provide the highest speed, torque, modulation rate, and positioning accuracy of any electric actuator in the Rotork Controls product line.

With the standard control electronics, they are self-contained automatic positioning devices capable of moving the largest loads at speeds typical of electrohydraulic devices, and with an unrestricted modulation rating. These high-performance actuators are electrically controlled, self-contained, high speed, high torque devices. With essentially unlimited rotational travel, they provide a superior solution for any modern actuation application.

The SM-6000 is designed using an all steel gear train submersed in an oil bath, and conservatively rated bearings. This design assures the longest possible life while reducing the risk of costly repairs and unscheduled maintenance.

An internally mounted electronic controller converts AC power input to DC power.

The DC power is then controlled by a microprocessor based digital servo amplifier that efficiently controls speed and torque of the drive motor.

The motor drives through high efficiency helical bevel gearing that provides smooth and quiet operation at rated load indefinitely in the event of power loss or shutoff.

A holding brake at the rear of the motor will hold the full rated load in the last position until power is restored. The holding brake is always in the released state whenever power is applied to the actuator. It is an electrically released, spring set type holding brake. The brake is constantly in a stand-by mode, and does not stop the motor. The motor does the braking electrically, so there is no wear on the brake because the brake is only holding, and not stopping the load. The load is always supported by the motor, even when the command input is not changing.

A manual override handcrank at the rear of the motor can be used to release the holding brake and manually position the load when power is interrupted.

The SM-6000 is well equipped with popular standard features, and a wide variety of standard options are available to suit most applications.

Special factory supplied options and designs are also available.

2 - Specifications

Output Torque ft. lb. (Nm)	Output Speed (RPM)	Shift Time (sec/90°)	Input Power Volts/Ph/Hz	Current Draw (A) at 240 VAC Input		Actuator Weight		Output Shaft Diameter	
				Running	Stall	lbs.	kg	inch	mm
370 (502)	1.50	10	120-240/1-3/50-60/3@120	2	6	186	85	1.25	31.75
550 (746)	1.50	10	120-240/1-3/50-60/4@120	2	6	186	85	1.25	31.75
800 (1085)	1.56	10	120-240/1-3/50-60/5@120	3	9	204	93	1.375	34.925
1400 (1898)	1.52	10	120-240/1-3/50-60/8@120	4	12	254	115	1.75	44.45
2500 (3389)	1.57	10	120-240/1-3/50-60/12@120	6	12	403	183	2.375	60.325
4400 (5965)	1.65	10	240/1-3/50-60/7	7	12	613	279	2.875	73.025
6200 (8406)	1.56	10	240/1-3/50-60/8	8	12	956	435	3.625	92.075
8000 (10846)	1.19	12	240/1-3/50-60/12	12	12	1589	722	4.375	111.125
11000 (14914)	0.86	18	240/1-3/50-60/12	12	12	1589	722	4.375	111.125
16500 (22371)	0.58	26	240/1-3/50-60/12	12	12	2196	998	4.75	120.65
26000 (36540)	0.36	42	240/1-3/50-60/12	12	12	3453	1570	5.5	139.7

- **Rotation:** 25° – 330°.
- **Duty Cycle:** Unlimited and unrestricted continuous duty.
- **Temperature:** -40 to 185 °F (-40 to 85 °C). A high temperature version to 225 °F (107 °C) is available.
- **Environment Ratings:** NEMA Type 4 (IP65).
- **Lubrication Type:** Synthetic oil bath.
- **Oil Change Interval:** 20 years for normal operation, 10 years for extreme operation.
- **Gearing:** All steel bevel and helical gearing.
- **Hold on Loss of Power:** Spring locking brake.
- **Mounting:** Conventional foot mounted.
- **Anti-Condensation Heater:** 120 or 240 VAC, 30 Watt with thermostat set for 110 °F (43.3 °C).
- **Torque Limit: Adjustable from 1 to 200% of rated torque. Warning: continued operation of unit in excess of rated load will damage the actuator and connected equipment.**
- **Positioning Accuracy:** 0.1% of 90°.
- **Position Limit Switches:** Two single pole double throw (SPDT) switches for end of travel use, rating: 20 amp, 120/240 VAC resistive load.
- **Feedback:** Absolute Encoder.
- **Local Controls & Display:** Front cover mounted control knobs and Vacuum Fluorescent Display (VFD).
- **Command Signal Input:** 4-20 mA, 0-5 VDC or 0-10 VDC.
- **Position Transmitter:** 4-20 mA transmitter used to remotely track actuator position when power is available to the actuator. Requires separate 24 VDC loop-power supply for operation.
- **Terminations:** Screw type terminals accepting up to #14 AWG wire.
- **Mounting Orientation:** Left hand, right hand or vertical.

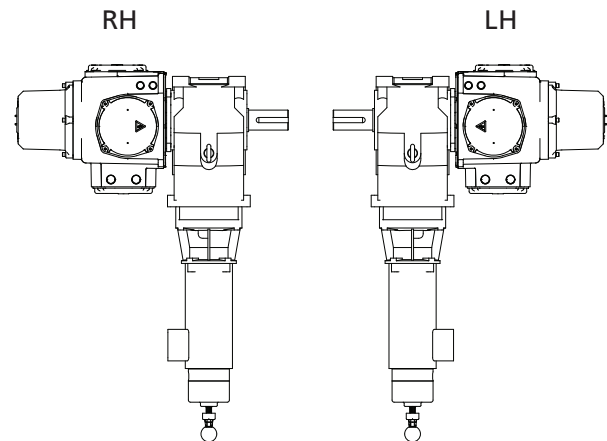

Figure 2.1. Left and right hand mounting orientation.

2.1 - Optional Equipment

- **Performance:** Faster speeds are available. Consult factory.
- **Drive Arm:** Steel, for dimensions see section 10.
- **Mechanical Stops:** A plate that bolts to the front of the actuator and limits drive arm movement is available
- **Relays:** Customer usable relay contacts are available to detect: loss of feedback, loss of command signal, loss of power or overtorque (stall).
- **Auxiliary Position Limit Switches:**
20 Amp, 120/240 VAC resistive load, (Quantity, 2-4)
5 Amp, 125 VDC resistive load, (Quantity, 2-4)
3 Amp, 250 VDC resistive load, (Quantity, 2-4)
- **Pluggable Connections:** Pluggable connectors on the control enclosure for quick-disconnection using Cannon style connectors. Typically used for remote mounted control enclosure applications.
- **Input Power:** Internally mounted transformer to allow operation on other input voltages. Standard optional Input voltages are 480 VAC, 575 VAC. A 120 VA to 240 VAC step-up transformer is also available for applications using 180 VDC motors when only 120 VAC input power is available.

Cabinet size may increase, or additional cabinets may be required.
- **Transitional Adapter Mounting Bases:** Matches SM-6000 to existing actuator footprint in the field for replacement applications. Consult factory.
- **High Temperature:** Optional for ambient temperature to 225 °F (107 °C). Requires remote control enclosure. Other options may be limited, consult factory.
- **Linkage Adapter/Clevis Kit:** Used to connect drive arm to driven load for linkage applications. Includes two clevises, two adjustment rods with lock nuts, two pipe adapters, two pins for clevises.

3 - Installation

Installation Notes



CAUTION

Read all instructions carefully before starting the installation in order to accustom yourself with this equipment. Follow all instructions during the installation. Do not apply power until told to do so or permanent damage can result.

1. Use care whenever carrying, setting, or working around the actuator. This is a precision piece of equipment that will be permanently damaged if dropped or mistreated during handling. Damage due to abuse or mishandling is not covered by the factory warranty.
2. The installation site must have environmental conditions compatible with the actuator design. Do not use this product in temperatures higher than the design allows, or in explosive environments if it is not rated accordingly. To maintain the environmental ratings, all covers must be tightly closed at all times. All cover fittings must be used and fastened securely. Using a $\frac{3}{16}$ " Hex key, remove the four capscrews securing the terminal compartment cover (Fig. 3.1). The actuator is supplied with a wiring diagram, certificate of conformance and terminal fixings stored in the terminal compartment area (Fig 3.2 and Fig 3.3).
3. Read the actuator nameplate located on the outside of the unit. It will reference a specific wiring diagram. Refer to the wiring diagram to identify functions of terminals (Fig. 3.2). Check that the supply voltage is the same as that marked on the actuator nameplate. That diagram **MUST** be used for wiring this product. Run wires as indicated, but **DO NOT** apply power until later. To prevent electrical noise pickup, power and signal wires must be routed through separate metallic conduit and the signal wires must also be shielded and the shield grounded (Fig. 3.1. A,B,C,D).

For actuators where the control enclosure must be located away from the actuator, **do not exceed a wire run distance of fifty feet between the actuator and the control enclosure.**

When all connections are made, replace the wiring diagram in the terminal compartment.

4. **Replace Terminal Cover** Ensure cover o-ring seal and joint are in good condition and lightly greased before re-fitting cover. Seal any unused conduit entries with metal plugs (Fig. 3.4. C,D).

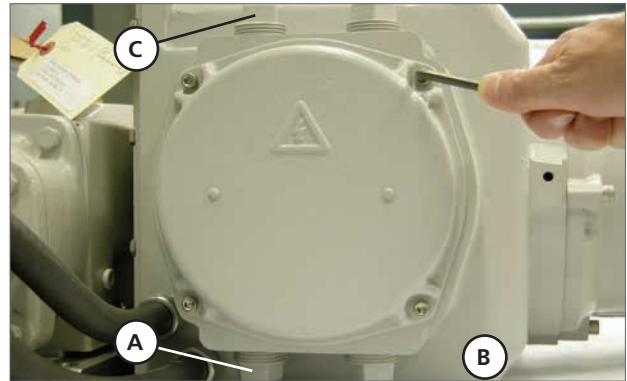

Figure 3.1. Terminal compartment cover



Figure 3.2. Terminal compartment.

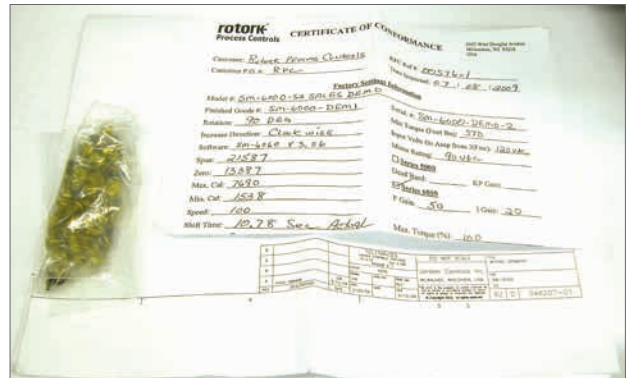

Figure 3.3. Terminal fixings.



Figure 3.4.

3 - Installation *cont.*

5. The actuator must be securely anchored to a rigid foundation before any load is applied to the output shaft. All of the actuator mounting holes designed for anchoring must have a bolt or stud, which should be of the largest size that fits in the mounting hole (Fig. 3.5. A).
6. The drive arm (if used) should be attached to the actuator output shaft using the hardware supplied. The drive arm has a hole to attach the linkage to the load. This linkage should be connected to the drive arm with a flexible rod-end to accommodate misalignment, and the rod-end must be sized for approximately twice the actuator full load rating (Fig. 3.5. B).
7. The actuator is designed to withstand the rigors of industrial environments. To maintain the environmental ratings, all cover fixings must be used and fastened securely (Fig. 3.6).

Mounting:

The outline and mounting dimensions for a standard unit are shown in this manual. Sufficient room to remove the cover should be provided for servicing and upgrade.

Orientation:

The unit is oil filled and must be mounted in the configuration ordered. When mounting the unit, be sure that no excessive axial or side loading is applied to the output shaft.

Output Drive Shaft:

The limit switches and position feedback are directly connected to the output shaft. Positively secure the output to the driven load shaft to prevent slippage, which would cause misalignment or damage.

Manual Override:

When manual override is required, push in handcrank and turn the crank in the appropriate direction for the desired output shaft movement. **Note:** Do not force handcrank if there is an obstruction as excessive torque will be generated at the output shaft. The load or actuator may be damaged as a result.

CAUTION - MANUAL OPERATION

With respect to hand crank operation of SM6000 series electric actuators, under no circumstances should any additional lever device such as a wheel-key or wrench be applied to the hand crank mechanism in order to develop more force when moving the actuator in either direction as this may cause damage to actuated device, associated linkages or actuator itself.

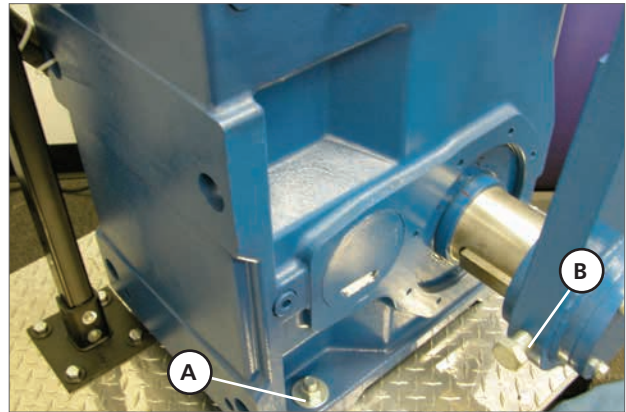

Figure 3.5.



Figure 3.6.



Figure 3.7.

3 - Installation *cont.*

If, during manual operation, electric power is restored to the actuator, the power cannot drive back through the manual handcrank and harm the operator. Upon completion of hand operation, the handcrank will spring return to its home position allowing electric operation to resume.

The handcrank and holding brake compartment at the rear of the motor relies upon the cover to maintain the watertight NEMA Type 4 rating. This cover should be removed only when work is being done internally, and should be reinstalled tightly immediately upon completion.

This unit contains no internal mechanical stops as standard. If it runs outside of the initial factory alignment of the limit switches, a realignment of switches and feedback may be required. However, no internal damage will occur.

The actuator is designed to give long, troublefree life when installed and operated in accordance with factory guidelines.

Position Limit Switches

The actuator is supplied with two Position Limit Switches PL1 (cam#1) & PL2 (cam#2) as standard (Fig. 3.8 and Fig. 3.9). These switches are mounted behind the control cover assembly and are typically set to operate outside the normal limits of travel to act as motor shutoff devices in the event of over travel.

Two optional switches PL3 (cam#3) and PL4 (cam#4) can be fitted to provide external travel limit switch indication.

Up to 4 additional switches can be supplied to provide external travel limit switch indication.

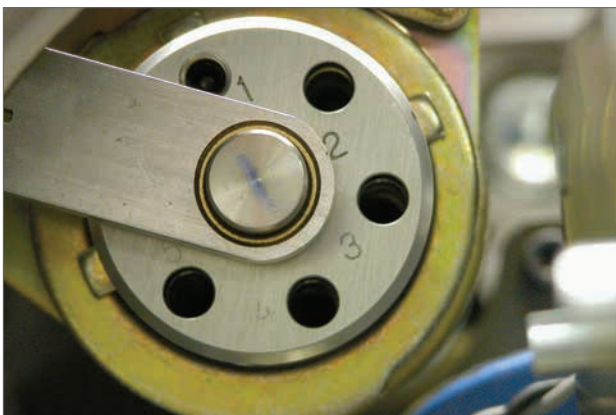

Figure 3.8.

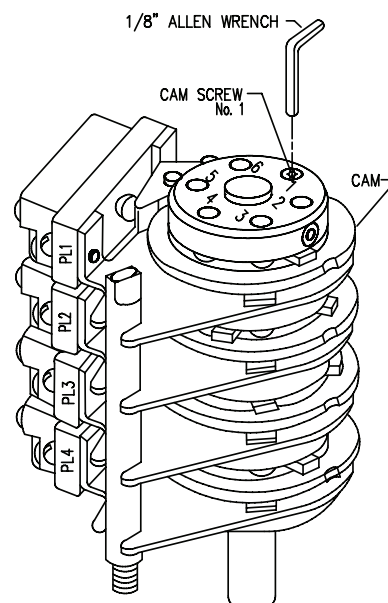

Figure 3.9.

3.1 - Installation Wiring & Typical Wiring Diagram

A typical wiring diagram is shown below. *Actual wiring should follow the print supplied with the actuator.* The wiring diagram shows the fundamental connections for the standard control scheme, and standard permanent magnet DC motor. Items shown on print arrangement include limit switches, feedback potentiometers, heater and encoders. To meet special requirements, certain items shown may not be supplied. *In all instances the wiring diagram appropriate to the equipment will be supplied with each unit.*

Wiring should be routed to the actuator through customer supplied conduit entries located on the control enclosure. Generally, one conduit will contain input power and earth ground wires. The other conduit would then contain low level input and output signal wiring. It is required that all low level signal wiring be a shielded type with the shield grounded at source common.

After installation, it is required that all conduits be sealed to prevent water damage and to maintain watertight NEMA 4 enclosure ratings.

TYPICAL WIRING DIAGRAM

Due to wide variations in terminal numbering of actuator products, actual wiring should follow the print supplied with the actuator. See actuator nameplate for drawing number.

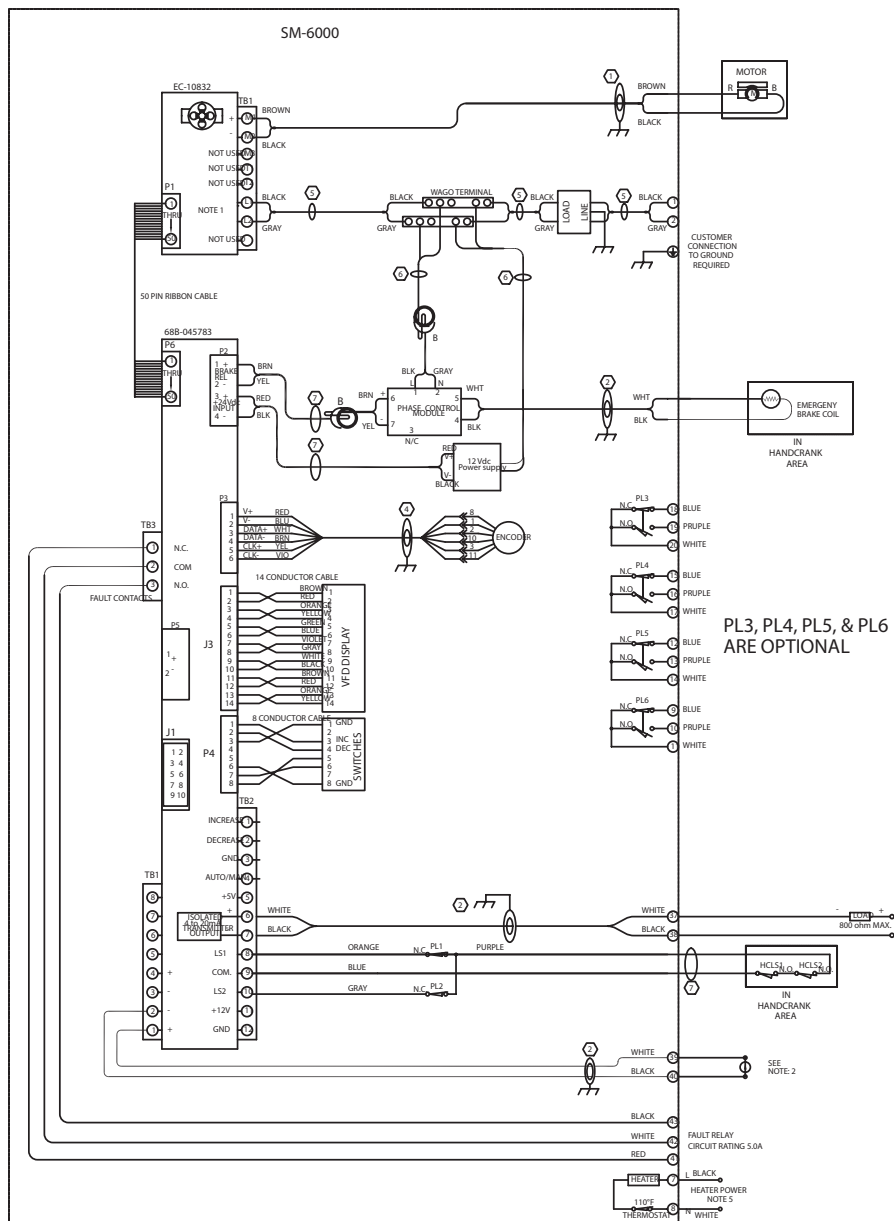

Figure 3.10. Typical SM6000-S2 Wiring Diagram

3.2 - Microprocessor Based Motor Drive & Controller Setup

General Description

The microprocessor-based motor drive and controller is designed for integral local or remote mount to control appropriate Rotork Controls actuators.

A microprocessor-based control and an IGBT-based intelligent power module (IPM) are used to drive the actuator to perform highly accurate, bidirectional positioning.

The 'Standard Setup' is made via front cover-mounted local control knobs and a local display (VFD) on the outside of the actuator. See figure 4.2 for location of the local control knobs and display.

The 'Alternative Setup' feature allows actuator setup using push-buttons (no potentiometers or jumpers). See figures 4.13 and 4.14 for location of the push buttons. Self diagnostics and prompts are available through an on-board lighted display.

Specifications

- **Power Input:** 120/240 VAC, +/- 10%, single or three phase, 50/60 Hz.
- **Power Output:** Up to 90 VDC/180 VDC, 15 Amperes Peak.
- **Command Inputs:** 4-20 mA into 200 Ohm shunt 0-10 VDC into 100k minimum impedance or 0-5 VDC into 100k minimum Impedance.
- **Position Feedback:** Absolute Encoder 1000 Ohm potentiometer (optional) 4-20 mA (optional).

Note: The factory default feedback settings were fully tested and initially setup at the factory and no other adjustment of the Absolute Encoder and 1000 Ohm Potentiometer should be required.

If adjustments are necessary please contact Rotork Controls.

- **Position Signal Output:** Loop powered, isolated, 2-wire 4-20 mA signal. Shows actuator position.
- **End of Travel Position Limit Switches :** Switch Cams 1 (CCW) & 2 (CW) to stop the actuator if end of travel position is exceeded.
- **Position Indication Switches:** (Optional) Switch cams 3 & 4 for additional position indication outputs. Up to 6 switches.
- **Automatic Mode:** Actuator responds to remote command input controls (typically 4-20 mA).
- **Manual Mode:** Actuator responds to local pushbutton commands.
- **Other Outputs:** Form C fault relay output
Contact Rating
120 VAC, 2 Amperes

Active when any of the following conditions are present:

- Loss of 4-20 mA command signal
- Loss of position feedback signal
- MIN/MAX limit switch reached
- Motor stalled condition
- Hand crank engaged
- Torque Limit Exceeded

4 - Operating your SM6000 Actuator



WARNING

Actuator may move when SPAN, ZERO or PRESET functions are selected.

Display-Local Indication

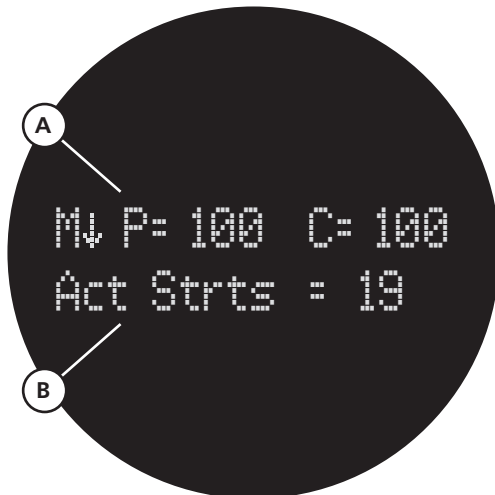

Figure 4.1.

The actuator Vacuum Fluorescent Display (VFD) provides 2 x 16 Character lines to allow setup and calibration of all user parameters. The display can also be utilised to access the diagnostic menus.

Line 1 (Fig. 4.1. A).

M = Manual Mode

A = Automatic Mode

R = Remote Communications Mode

S = Setup Mode

In Manual, Remote and Automatic Modes line 1 shows actuator Position and Command request in percentage of Zero - Span range.

P = Actual Position

C = Command Position

Line 2 (Fig. 4.2. B).

Act strts = Actuator starts

Provides status or fault information depending on Mode selected.

Local Control Knobs

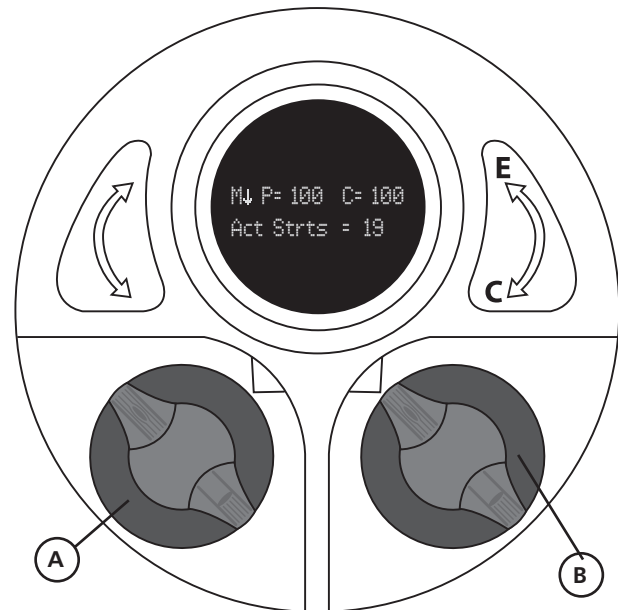

Figure 4.2.

The actuator has two control knobs located below the VFD Display window.

UP/DOWN SELECTOR KNOB (Fig. 4.2. A).

Located on left hand side as viewed from the front. Depending on mode selected different functions apply (see below).

ENTER/CANCEL KNOB (Fig. 4.2. B).

Located on right hand side as viewed from the front. Allows parameters to be changed and accepted or toggles between menus.

Manual Mode

Rotate the selector knob anti-clockwise (UP) and hold to move actuator output towards the Span Position. Release when the actuator has reached the desired position.

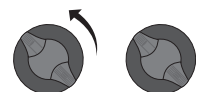

Rotate the selector knob clockwise (Down) and hold to move actuator towards the Zero position. Release when the actuator has reached the desired position.

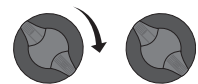

Setup Mode

Rotate the selector knob to the UP or DOWN position to cycle through the setup menu parameters.

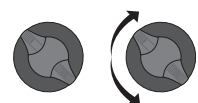

4.1 - Status Description

Status Description

In **AUTO** or **MANUAL** mode Line 2 of the display shows status parameters when no faults are active.

Use the Enter/Cancel knob to cycle through the information (Fig. 4.3).

- 1 **Amp Starts = xxxxx**
Total times the amplifier has been powered up or reset.
- 2 **Act Starts = xxxxx**
Total times the motor has been started since last power up.
- 3 **Temp. °C xx**
Temperature in °C of the lower internal PCB's.
- 4 **Voltage xxx**
Absolute value of DC motor voltage.
- 5 **Current +/- xxxxx**
Motor current.
- 6 **TORQUE**
Current torque output XXX%.
- 7 **FAULT HISTORY**
Lists the last 10 faults or events. Select **ENTER** to activate. F0 is the most recent event F10 would be the oldest.
M FAULT HISTORY
F0 Los cmd
- 8 **Motor PWM**
Command used to represent motor speed in function of maximum pulse width modulation.

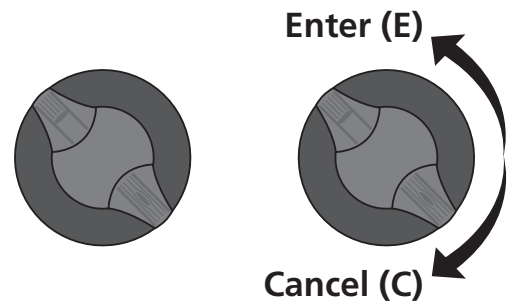
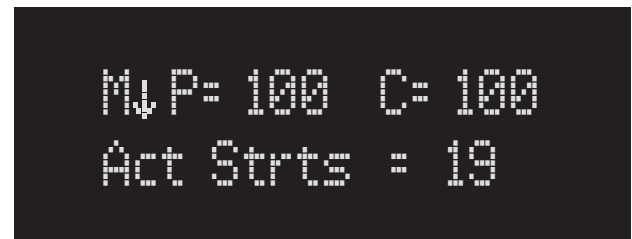
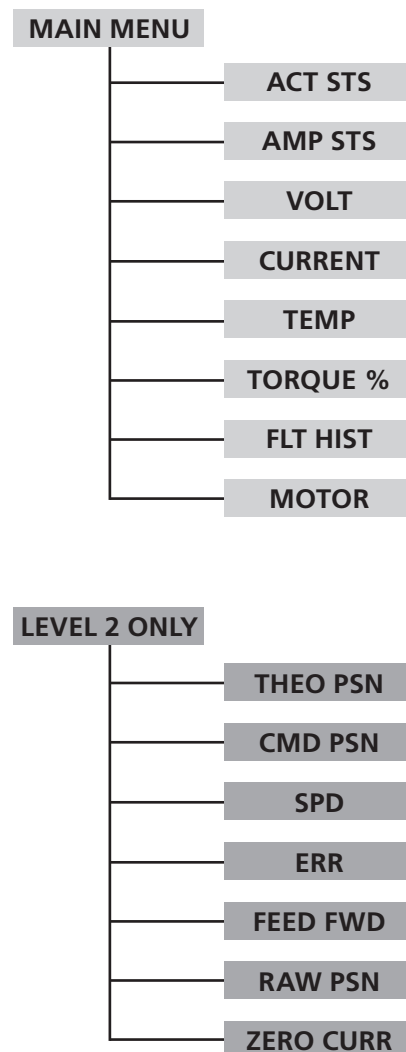

Figure 4.3.



4.2 - Start Up

The actuator is fully tested and initially setup at the factory. The factory default settings should be used to initially commission the actuator on site.

WITH POWER OFF & LOAD DISCONNECTED

Verify that all wiring is correct and that the supply voltage matches the voltage shown on the actuator identification label. Refer to the wiring diagrams supplied with the actuator for specific details (Fig. 4.4).

Ensure all electrical connections are tight and splash guard refitted. Cable screens/shields must be suitably connected to a reliable earth ground (Fig. 4.4).

To maintain the environmental ratings, all cover fixings must be used and fastened securely (Fig. 4.5).

REMOVE CONTROL ASSEMBLY COVER (OPTIONAL)



CAUTION

DO NOT FULLY REMOVE COVER UNLESS THE WIRING LOOMS ARE DISCONNECTED FROM THE MAIN PCB.

It is only necessary to remove the control cover assembly to adjust and setup the position limit switch assemblies located inside the control housing.

If the limit switches do not require adjustment leave the cover assembly in place and go to Page 19 (Fig. 4.15).

Locate and remove four socket cap screws using a 1/4" Hex key which secure the control assembly cover to the gearcase (Fig. 4.6). Remove the cover far enough to clear the electrical chassis taking care not to damage cables connecting the VFD display and control knobs to the Logic control PCB. If necessary disconnect the two cables from the Logic Control PCB to the cover assembly (Fig. 4.7).

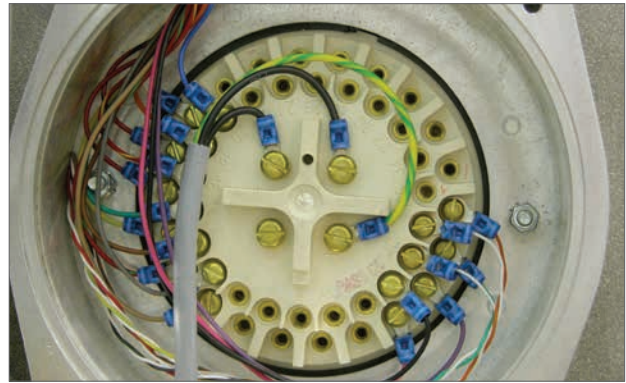

Figure 4.4.



Figure 4.5.



Figure 4.6.

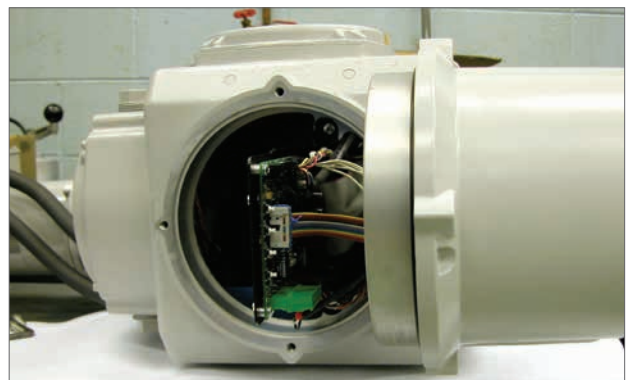

Figure 4.7.

4.2 - Start Up *cont.*

The cover assembly can now be relocated on to the left or right hand side of the gear-case to facilitate setup. Use one of the original fixings to secure the control cover assembly to the gear-case (Fig. 4.8).



Figure 4.8.

Reconnect looms to the main PCB if necessary (Fig. 4.9).



Figure 4.9.

REMOVE TOP & SIDE COVER ASSEMBLIES

The top and side cover assemblies may be removed for clearer access to the Limit Switch assemblies. $\frac{3}{16}$ " Hex key.

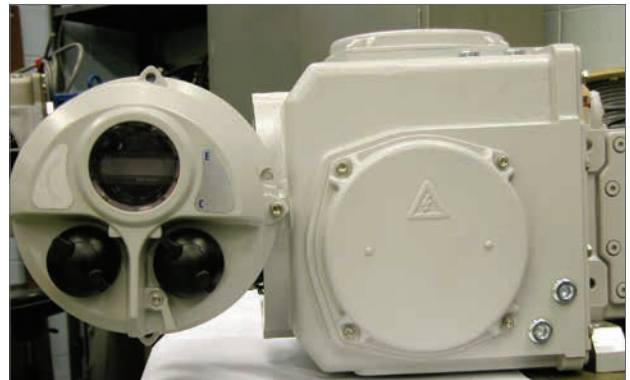

Figure 4.10.

Figure 4.11 shows top cover removed of an actuator fitted with additional position limit switches for remote indication.

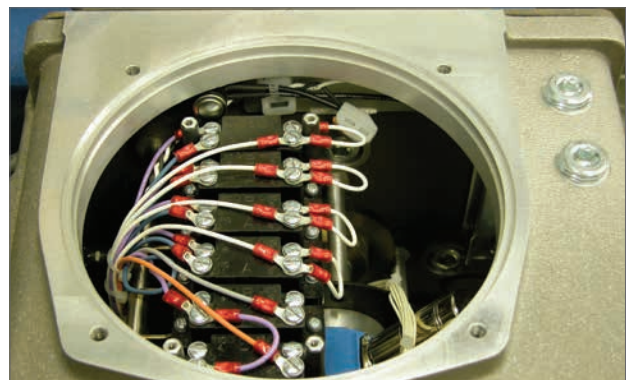

Figure 4.11.

4.2 - Start Up *cont.*

Figure 4.12 shows the front view of the electrical chassis.

LOGIC CONTROL PCB

Figure 4.13 shows the logic Control PCB.

The PCB has one push button switch (SW1) (Fig. 4.13. A) located at right top corner of the PCB and four push button switches (SW2 to 5) located on the forward edge of the PCB.

If desired the switches SW2 to 5 can be used to duplicate the function of the control knobs.

SW1 RESET (NOT SHOWN)

Clears microprocessor registers and restarts the control program. *Do not press during normal operation.*

SW2 INCREASE

Manual Mode: Press and hold to move the actuator towards the Span position.

Setup Mode: Press to cycle through the setup menu parameters.

Actuator will move when **SPAN**, **ZERO** or **PRESET** functions are selected.

SW3 MODE

Switches between **AUTO/MANUAL** and **SETUP** mode. Aborts a parameter change when in **SETUP** mode.

SW4 ENTER

Allows changed parameters to be stored and cycling of diagnostic display.

SW5 DECREASE

Manual Mode: Press and hold to move the actuator towards the Zero position.

Setup Mode: Press to cycle through the setup menu parameters. Actuator will move when **SPAN**, **PRESET** and **ZERO** functions are selected.

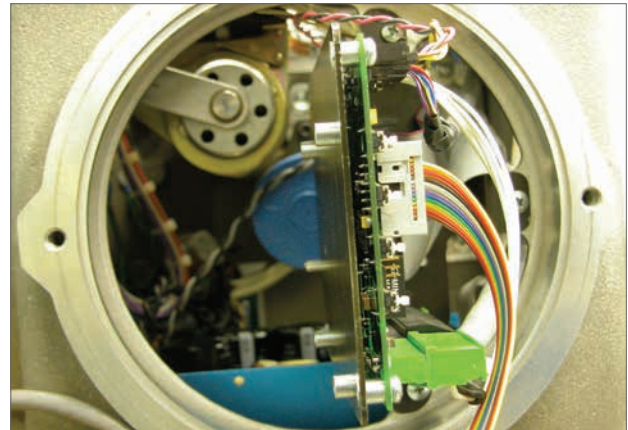

Figure 4.12.

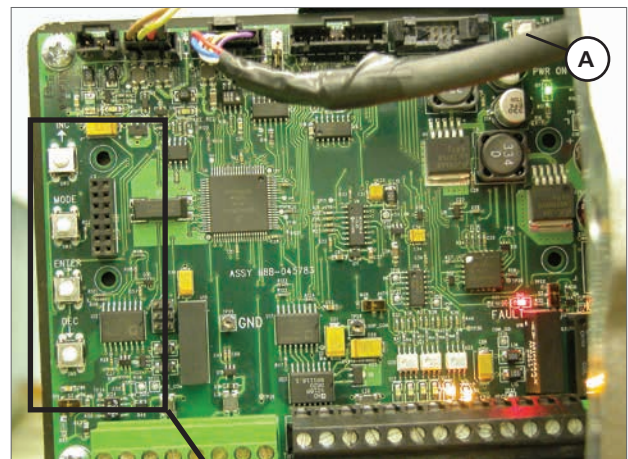

Figure 4.13.

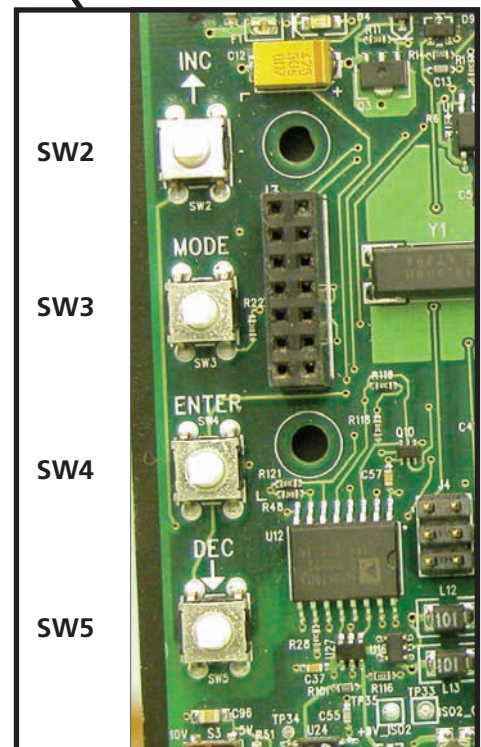

Figure 4.14.

4.2 - Start Up *cont.*

ENSURE THAT LOAD IS DISCONNECTED FROM ACTUATOR OUTPUT DRIVE SHAFT.

APPLY POWER TO ACTUATOR

The actuator display should now illuminate showing actuator model and software version for 5 seconds before displaying the top menu (Fig. 4.15).

The actuator is set to **MANUAL** Mode when it leaves the factory (Fig. 4.16).



Figure 4.15.



Figure 4.16.

MANUAL MODE - OPERATION

With no load connected to the actuator output drive shaft.

Rotate the **UP/DOWN** Control knob clockwise and anti-clockwise to test electrical operation. Confirm that the direction of travel corresponds with the rotation of the knob. Refer to Section 4.

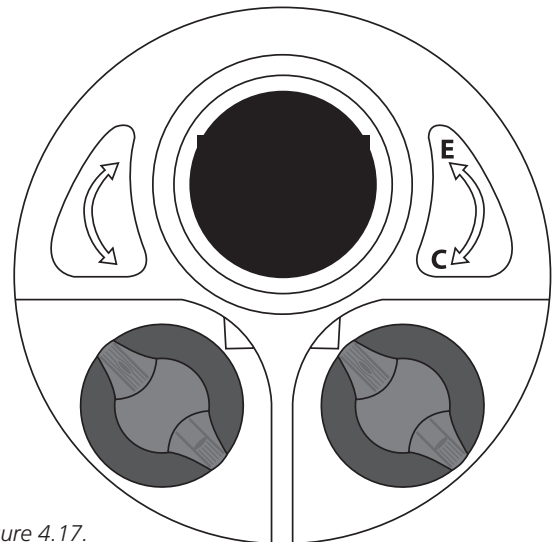

Figure 4.17.

AUTOMATIC MODE - OPERATION

The actuator control mode must now be changed to '**AUTOMATIC**' to function test the actuators response to Analogue control signal commands.

Ensure that actuator has been correctly configured for current or Volts before applying any analogue command inputs.

If actuator is supplied with a Bus or HART input card please refer to section 5.1.

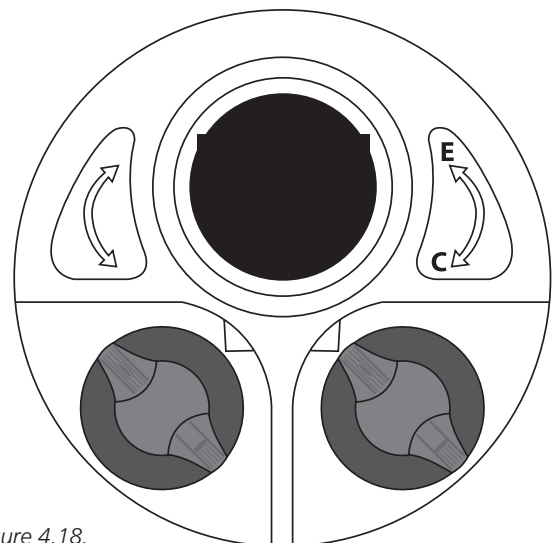

Figure 4.18.

4.2 - Start Up *cont.*

4.2.1 SELECT AUTOMATIC MODE

Display shows actuator set to Manual Mode
Position 100% (Fig. 4.19).

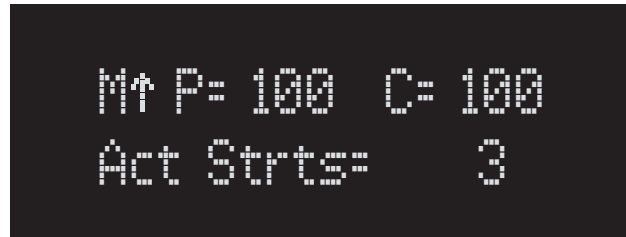
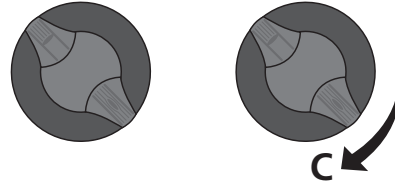

Figure 4.19.

ENTER KNOB - SELECT 'CANCEL'



SETUP MODE

Display now shows Setup Menu (Fig. 4.20).



Figure 4.20.

UP/DOWN KNOB - SELECT 'PARAMETER'

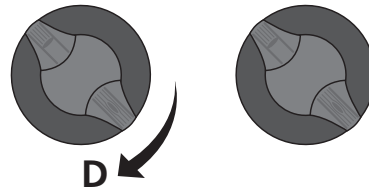

Use the UP/DOWN knob to scroll through menus until 'Ctrl Type = Man' is displayed, result is (Fig. 4.22).

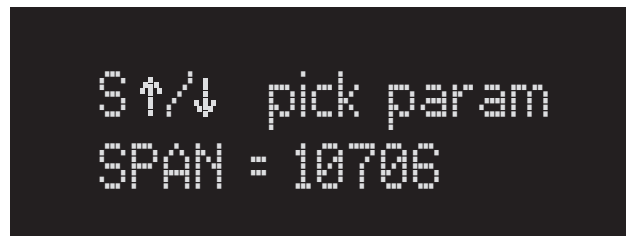

Figure 4.21.

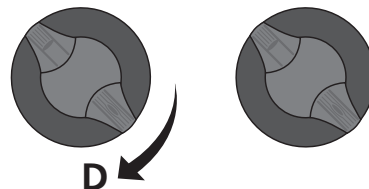
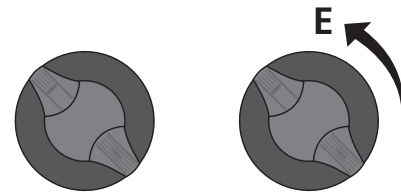

Figure 4.22.

4.2 - Start Up *cont.*

ENTER KNOB - SELECT 'ENTER'

Select 'ENTER' to enable changes to actuator configuration.
Result is (Fig. 4.23).



```
↑/↓ to Ctrl Type
ENT = accept Man
```

Figure 4.23.

UP/DOWN KNOB - SELECT 'AUTO'

The control type can be changed by rotating the UP/DOWN knob. Select 'AUTO' Function. Result is (Fig. 4.24).

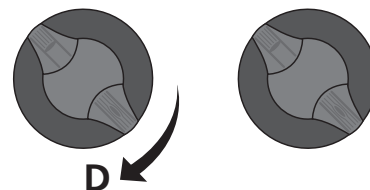

```
↑/↓ to Ctrl Type
ENT = accept Auto
```

Figure 4.24.

ENTER KNOB - SELECT 'ENTER'

Select 'ENTER' to store changes to the actuator configuration. Result is (Fig. 4.25).

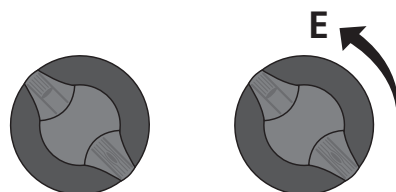

```
S ↑/↓ pick param
Ctrl Type = Auto
```

Figure 4.25.

NOTE:

CYCLING THE POWER TO THE ACTUATOR AT THIS STAGE WILL REMOVE RECENT CHANGES.

TO AVOID LOSS OF SETTINGS USE UP/DOWN KNOB TO SCROLL TO THE 'SAVE CONFIG' MENU Result is (Fig. 4.26).

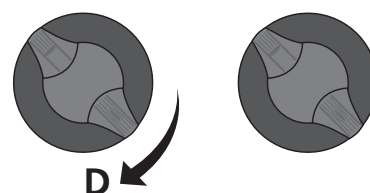

4.2 - Start Up *cont.*

SAVE CONFIG



Figure 4.26.

ENTER KNOB - SELECT 'ENTER'

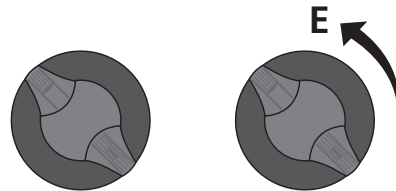

SAVING TO EEPROM

All changes saved to EEPROM (Fig. 4.27). All changes to Parameters will be saved when cycling of power occurs.



Figure 4.27.

ENTER KNOB - SELECT 'CANCEL'

Display returns to top menu and **AUTOMATIC** Mode is now active. The lower section of the display will show the last selected menu option.

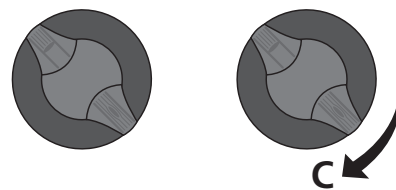

Actuator will now respond to applied Analogue Remote input signal. Apply a 50% command signal (mA or Voltage) to the actuator. Verify that the actuator moves the output to desired position (Fig. 4.28).



Figure 4.28.

Apply a 00% command signal (mA or Voltage) to the actuator. Verify that the actuator moves the output to desired position (Fig. 4.29).



Figure 4.29.

Apply a 100% command signal (mA or Voltage) to the actuator. Verify that the actuator moves the output to desired position (Fig. 4.30).



Figure 4.30.

INITIAL COMMISSIONING COMPLETE.

4.3 - Range of Operation - Setup

4.3.1 RANGE OF OPERATION

The following procedure will calibrate the **ZERO** and **SPAN** limits of travel and adjustment of the Position Limit Switches if necessary.

With Linkage disconnected apply power to the unit.

The actuator should be in manual mode to start this operation as noted in Figure 4.32. Refer to section 4 for instructions. The unit may have been moved out of its normal limits of electrical travel for shipping purposes. In this case Figure 4.32 shows the actuator at 149% of travel. The actuator will respond to decreasing requests only, until it reaches the 100% position of travel, after which it may be driven in either direction between limits (Fig. 4.33).

During operation it is possible that one end of travel switch is tripped and adjustment is required to facilitate movement to the desired **SPAN** or **ZERO** position. In this case it will be necessary to adjust one or both of the travel limit switches.

Fig 4.34 shows that the increasing limit switch cam#1 has been activated.



WARNING

Isolate power supply before inserting tools in to the electrical housing.

Move actuator output shaft in the increasing direction and observe rotation of cam switch assembly to verify CW or ACW operation. Using a 1/8" hex wrench loosen the appropriate locking screw (screws are numbered on the cam end plate) (fig 4.36).

Move the switch cam in the decreasing direction to allow the actuator to run its full required position of travel. Once adjusted tighten the locking screw.

Repeat the procedure for the Decreasing travel limit if necessary.

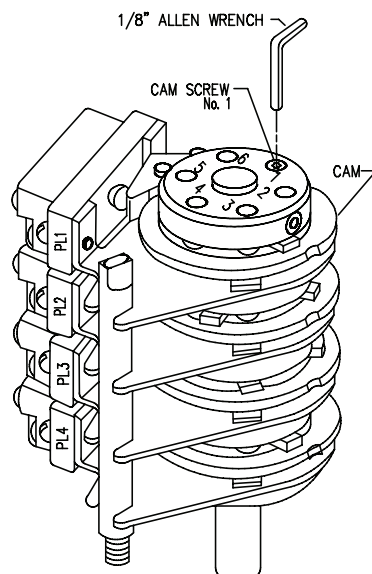

Figure 4.36.



Figure 4.31.



Figure 4.32.



Figure 4.33.

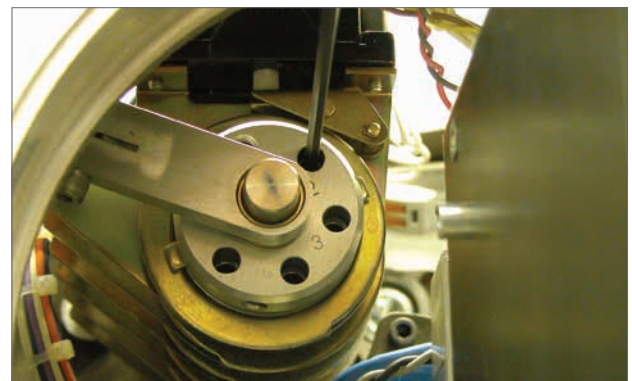

Figure 4.34.

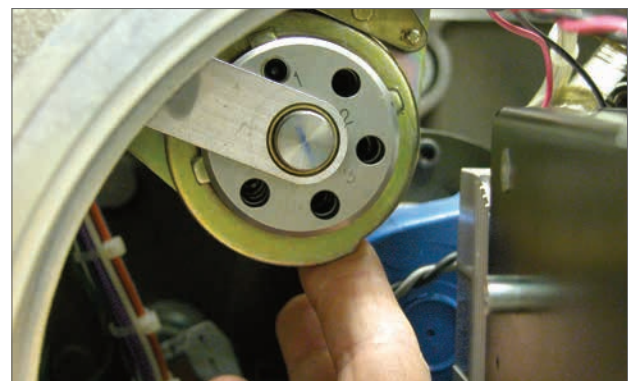

Figure 4.35.

4.3 - Range of Operation - Setup *cont.*

OPERATING SPEED

The actuator output speed is factory preset to 100%. During the initial calibration of this unit it is recommended that the speed is reduced to 10% to achieve greater accuracy when setting the ZERO and SPAN position limits.

To change the actuator speed.



Figure 4.37.

ENTER KNOB - SELECT 'CANCEL'

Change Mode from manual to Setup.

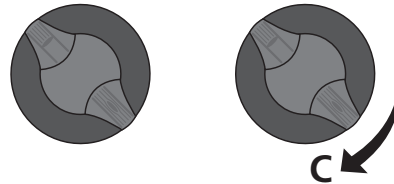

Figure 4.38.

UP/DOWN KNOB - SELECT 'MENU'

Use the UP/DOWN knob to scroll through menus.

Until 'Speed = XXX' is displayed (Fig. 4.39).

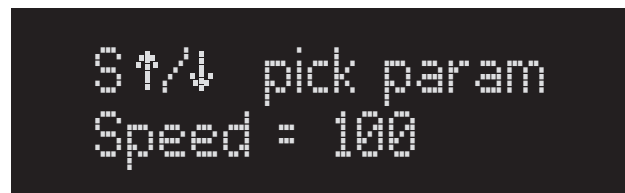
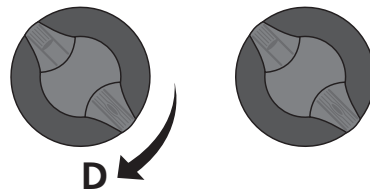

Figure 4.39.

ENTER KNOB - SELECT 'ENTER'

The motor speed can now be adjusted by using the UP/DOWN knob.

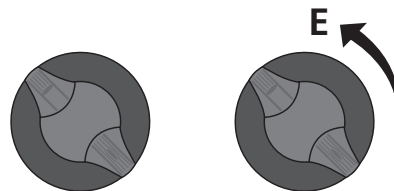

Figure 4.40.

4.3 - Range of Operation - Setup *cont.*

UP/DOWN KNOB - HOLD TO REDUCE SPEED

Hold the UP/DOWN KNOB until the actuator speed indicates 10% (Fig. 4.41).

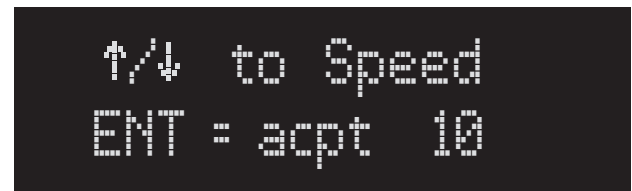
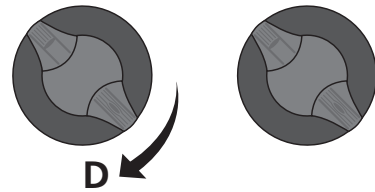

Figure 4.41.

ENTER KNOB - ENTER TO SAVE VALUE

Select 'ENTER' to set the actuator speed to 10% (Fig. 4.42).

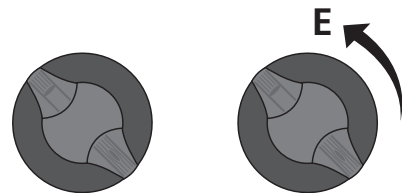

Figure 4.42.

UP/DOWN KNOB - SELECT 'SAVE CONFIG'

Actuator configuration should be saved to EEPROM before exiting the menu (Fig. 4.43).

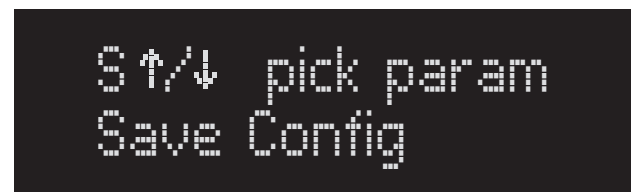
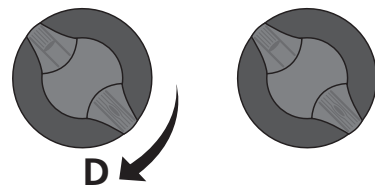

Figure 4.43.

4.3 - Range of Operation - Setup *cont.*

ENTER KNOB - ENTER TO SAVE TO EEPROM

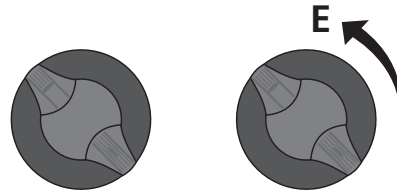

Figure 4.44.

ENTER KNOB - SELECT 'CANCEL' TO RETURN TO TOP MENU (Fig. 4.45).

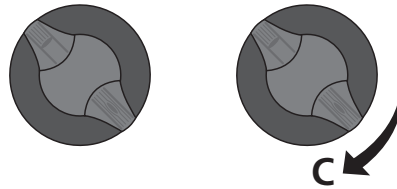

Figure 4.45.

4.3 - Range of Operation - Setup *cont.*

4.3.2 SET ZERO AND SPAN

ENSURE THAT LOAD IS DISCONNECTED FROM ACTUATOR OUTPUT DRIVE SHAFT.

The operating speed of the actuator is now set to 10% of rated. The **ZERO** and **SPAN** can now be set.

Note: Careful attention must be used during the setting of the **ZERO** and **SPAN** of the actuator. Typically the **ZERO** and **SPAN** positions are set just inside or at the full open and full closed positions. If necessary, use two people during the setup procedure. One person to run the actuator and the second person to verify the position of the device coupled to the actuator.

End of Travel Position Limit Switches :

The actuator is fitted with two Position Limit switches to prevent electrical operation beyond the set Zero and Span positions.

During operation it is possible that the Position Limit Switches are tripped and 'Flt. Inc or Dec Limit, is displayed (Fig. 4.47). To adjust Limit switch positions (see start of section 4.3).

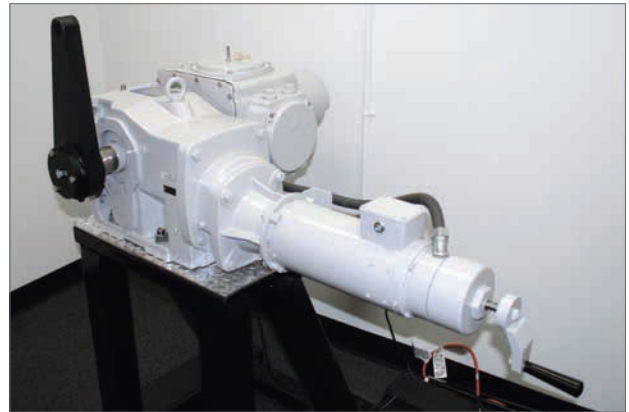

Figure 4.46.



Figure 4.47.

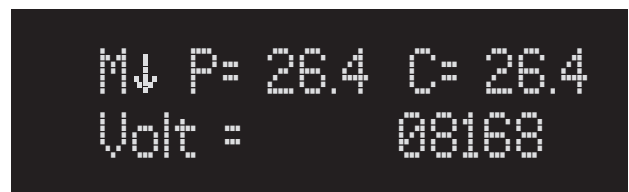

Figure 4.48.

4.3 - Range of Operation - Setup *cont.*

SET ZERO POSITION

The ZERO position is the position that the actuator will travel to when given its minimum command. Typically this is the closed position of the device. To set the ZERO position, follow the procedure below:

ENTER KNOB - SELECT 'CANCEL' TO ENTER SETUP MODE

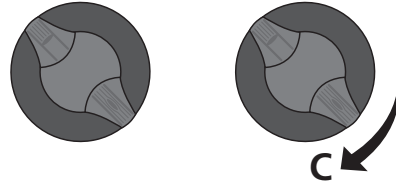

```
S ↑/↓ pick param
Press
```

Figure 4.49.

UP/DOWN KNOB - SELECT 'ZERO' MENU

The actuator position in this menu is shown as a 5 digit encoder count (Fig. 4.50).

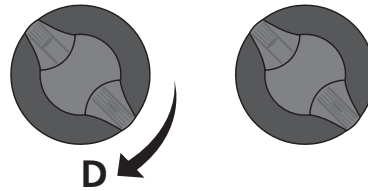

```
S ↑/↓ pick param
ZERO = 06616
```

Figure 4.50.

4.3 - Range of Operation - Setup *cont.*

Use UP/DOWN knob to move actuator output to desired ZERO position.

ENTER KNOB – SELECT 'ENTER' TO ADJUST ZERO POSITION

Whilst at the desired ZERO position - Select 'ENTER' to Set the new ZERO position. (Fig. 4.51).

Note: the parameter changes must be saved to configuration to prevent loss of data.

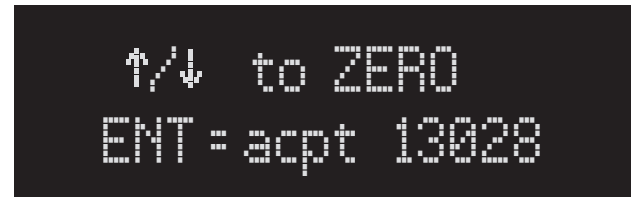
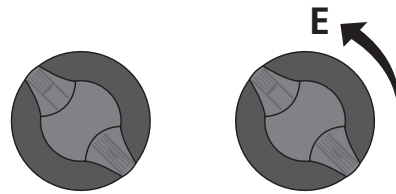

Figure 4.51.

UP/DOWN KNOB - SELECT 'SAVE CONFIG' MENU

Rotate the UP/DOWN knob until the display reads Save Config (Fig. 4.52).

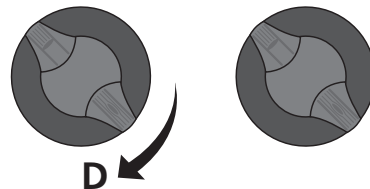

Figure 4.52.

ENTER KNOB - ENTER TO SAVE TO EEPROM

Actuator configuration must be saved to EEPROM before exiting the menu (Fig. 4.53).

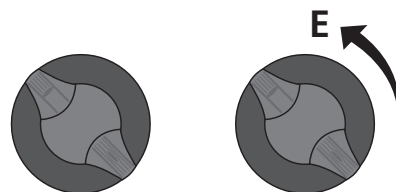

Figure 4.53.

4.3 - Range of Operation - Setup *cont.*

SET SPAN POSITION

The **SPAN** position is the position that the actuator will travel to when given its maximum command. Typically this is the open position of the device. To set the **SPAN** position, follow the procedure below:

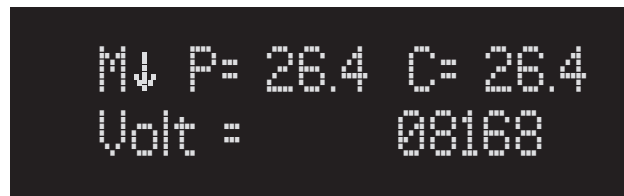

Figure 4.55.

ENTER KNOB - SELECT 'CANCEL' TO ENTER SETUP MODE

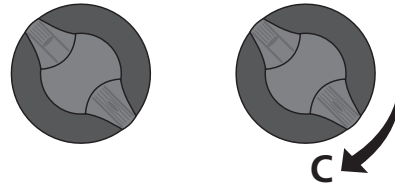

Figure 4.56.

UP/DOWN KNOB - SELECT 'SPAN' MENU

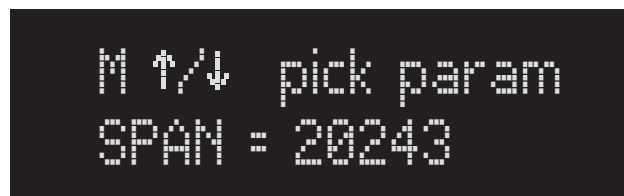
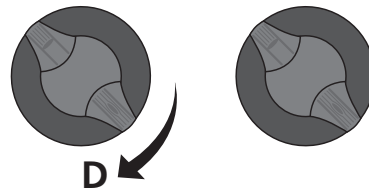

Figure 4.57.

SET SPAN POSITION

ENTER KNOB - SELECT 'ENTER' TO ADJUST POSITION

Use UP/DOWN knob to move actuator output to desired SPAN position.

ENTER KNOB - SELECT 'ENTER' TO SAVE SPAN POSITION

Whilst at the desired SPAN position - Select 'ENTER' to Set the new SPAN position.

While at the desired position, Rotate the **ENTER** knob to accept the value. The actuator position in this menu is shown as a 5 digit encoder count (Fig. 4.58).

Note: the parameter changes must be saved to configuration to prevent loss of data.

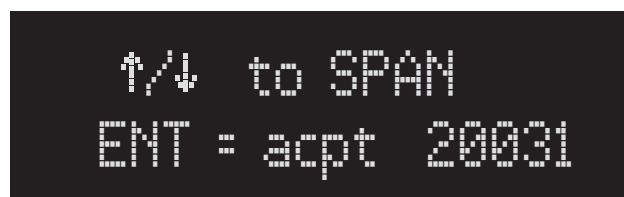
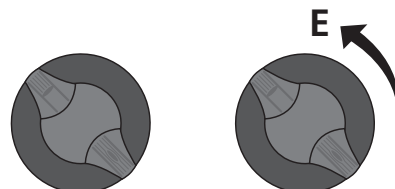

Figure 4.58.

4.3 - Range of Operation - Setup *cont.*

UP/DOWN KNOB - SELECT 'SAVE CONFIG' MENU

Rotate the UP/DOWN knob until the display reads *Save Config*. (Fig. 4.59).

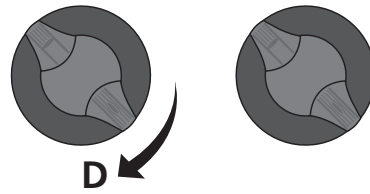

Figure 4.59.

ENTER KNOB - ENTER TO SAVE TO EEPROM

Actuator configuration must be saved to EEPROM before exiting the menu (Fig. 4.60).

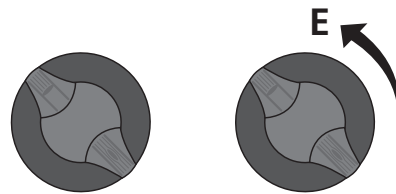

Figure 4.60.

ENTER KNOB - SELECT 'CANCEL'

Select 'CANCEL' to exit setup mode.

The **SPAN** position has now been set (Fig. 4.61).

If limits have not been set adjustment of the position limit switches is required. See start of section 4.3.

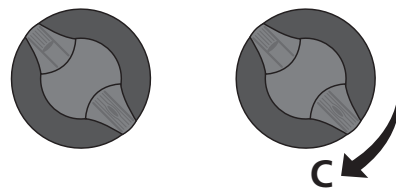

Figure 4.61.

4.3 - Range of Operation - Setup *cont.*

4.3.3 SETTING LIMIT SWITCHES

SET INCREASING POSITION LIMIT SWITCH CAM#1

It is now possible to set the CW & ACW position limit switches.

With actuator set to **MANUAL** mode (see section 4.2) move output shaft to the **ACW** end of travel position. As viewed from the lever output shaft end.

This could be the **ZERO** or **SPAN** position depending on configuration.

The switch acts as an emergency backup to de-energize the motor drive and is generally set to trip if the actuator is operated outside the **SPAN** or **ZERO** travel positions.

Locate locking set screw #1 on the switch cam end plate assembly.

With a 1/8" Hex key loosen (**DO NOT REMOVE**) locking grub screw (Fig. 4.62).

Rotate the cam **CW** until the switch operates (Fig. 4.64) then back off so that the cam just releases the switch.

Tighten the set screw (Fig. 4.65).

The switch is now set to operate just after the anti-clockwise (**ZERO** or **SPAN**) position is reached.

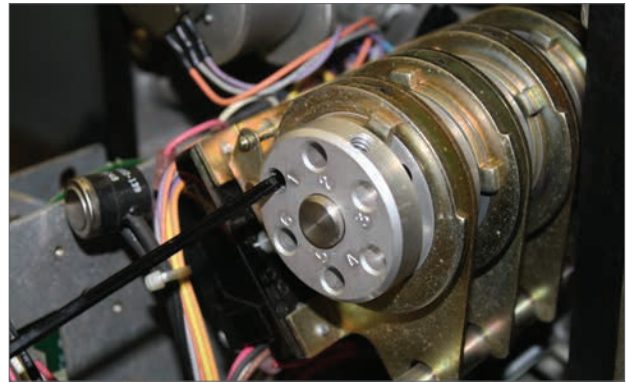

Figure 4.62.



Figure 4.63.

SET DECREASING POSITION LIMIT SWITCH CAM#2

With actuator set to **MANUAL** mode (see section 4.2) move output shaft to the **CW** end of travel position. As viewed from the lever output shaft end.

This could be the **ZERO** or **SPAN** position depending on configuration.

Locate locking set screw #2 on the switch cam end plate assembly (Fig. 4.63).

With a 1/8" Hex key loosen (**DO NOT REMOVE**) locking grub screw.

Rotate the cam **ACW** until the switch operates then back off so that the cam just releases the switch (Fig. 4.64).

Tighten the set screw (Fig. 4.65).

The switch is now set to operate just after the ACW (**ZERO** or **SPAN**) position is reached.

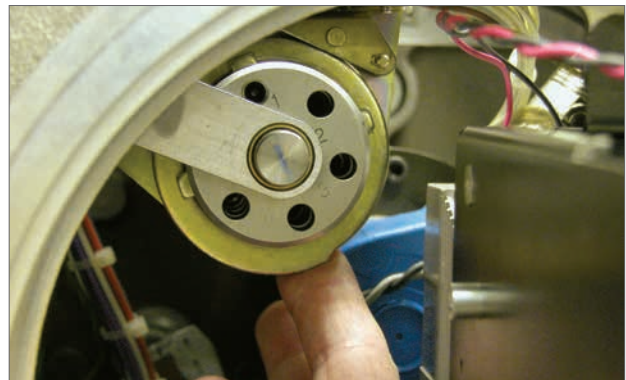

Figure 4.64.

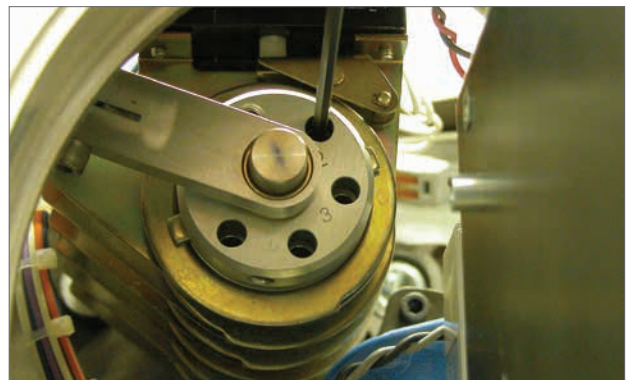

Figure 4.65.

Note:

CW = Clockwise

ACW = Anti-Clockwise (Counter- Clockwise)

4.3 - Range of Operation - Setup *cont.*

SET ADDITIONAL LIMIT SWITCHES (If fitted)

Repeat the procedure for switches CAM #3 to #6 as required.

REFIT TOP AND SIDE COVERS

Check condition of o-ring seals (replace if necessary) and refit cover assemblies.

REFIT LOCAL CONTROL COVER ASSEMBLY

Remove the control cover assembly from its temporary.

position and refit to front of control housing. Take care not to damage looms between the cover assembly and the main PCB. Disconnect wiring looms if necessary. Be sure to check condition of the o-ring seals (replace if necessary) and refit with cover.

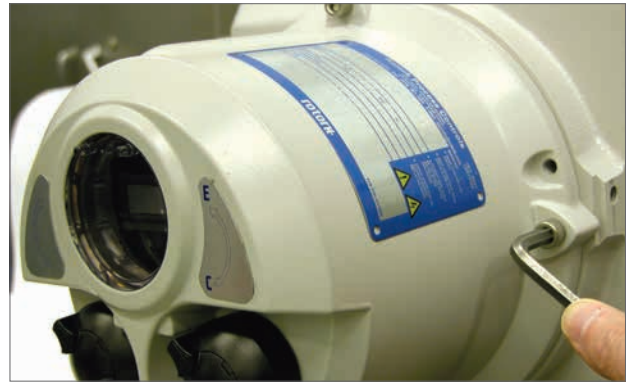

Figure 4.66.

4.3 - Range of Operation - Setup *cont.*

4.3.4 OPERATING SPEED

The actuator output speed can now be changed to suit the process requirement.

To change the actuator speed.



Figure 4.67.

ENTER KNOB - SELECT 'CANCEL'

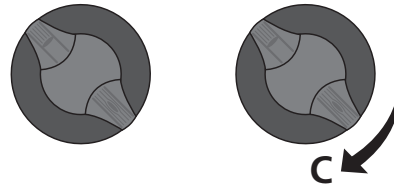

Figure 4.68.

UP/DOWN KNOB - SELECT 'MENU'

Use the UP/DOWN knob to scroll through menus until 'Speed = XXX' is displayed (Fig. 4.69).

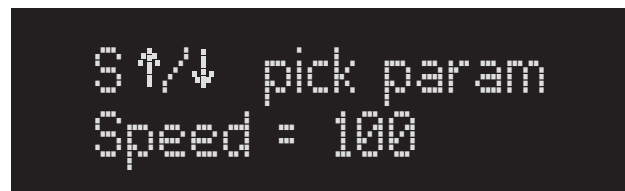
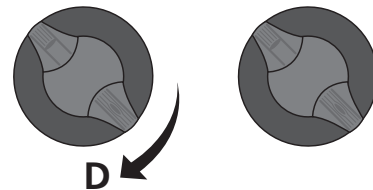
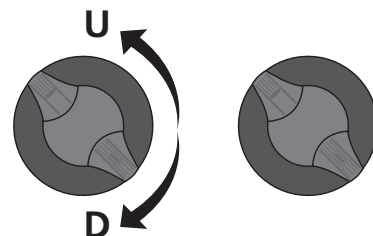

Figure 4.69.

UP/DOWN KNOB - SELECT SPEED

The motor speed can now be adjusted by using the UP/DOWN knob until the display shows the desired speed (10 - 100%) (Fig. 4.69).



4.3 - Range of Operation - Setup *cont.*

ENTER KNOB - ENTER TO SAVE VALUE

Set new speed setting.

NOTE:
CYCLING THE POWER TO THE ACTUATOR
AT THIS STAGE WILL REMOVE RECENT
CHANGES.

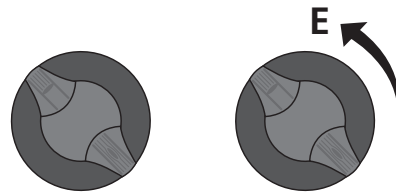

```
↑/↓ to Speed
ENT = acpt 100
```

Figure 4.70.

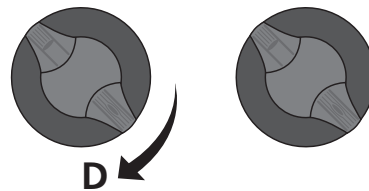

TO AVOID LOSS OF SETTINGS USE UP/DOWN
KNOB TO SCROLL TO THE 'SAVE CONFIG'
MENU (Fig. 4.71).

```
S ↑/↓ pick param
Save Config
```

Figure 4.71.

ENTER KNOB - ENTER TO SAVE VALUE

Save new speed setting to EEPROM (Fig. 4.72).

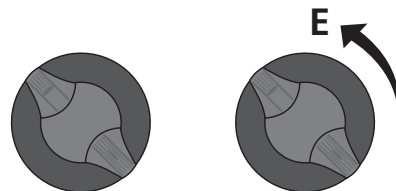

```
S ↑/↓ pick param
Saving to EEPROM
```

Figure 4.72.

ENTER KNOB - CANCEL TO EXIT MENU

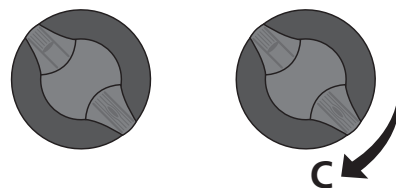

5 - Setup and Calibration

SM-6000 S2 MENU STRUCTURE

There are two levels of Setup and Calibration.

Level 1: Customer Settings for initial setup and fine tuning of the actuator operation.

Level 2: Diagnostic and Advanced Settings (Section 5.3).
User may wish to consult Rotork Controls before making changes to level 2 parameters.

LEVEL 1 MENU STRUCTURE

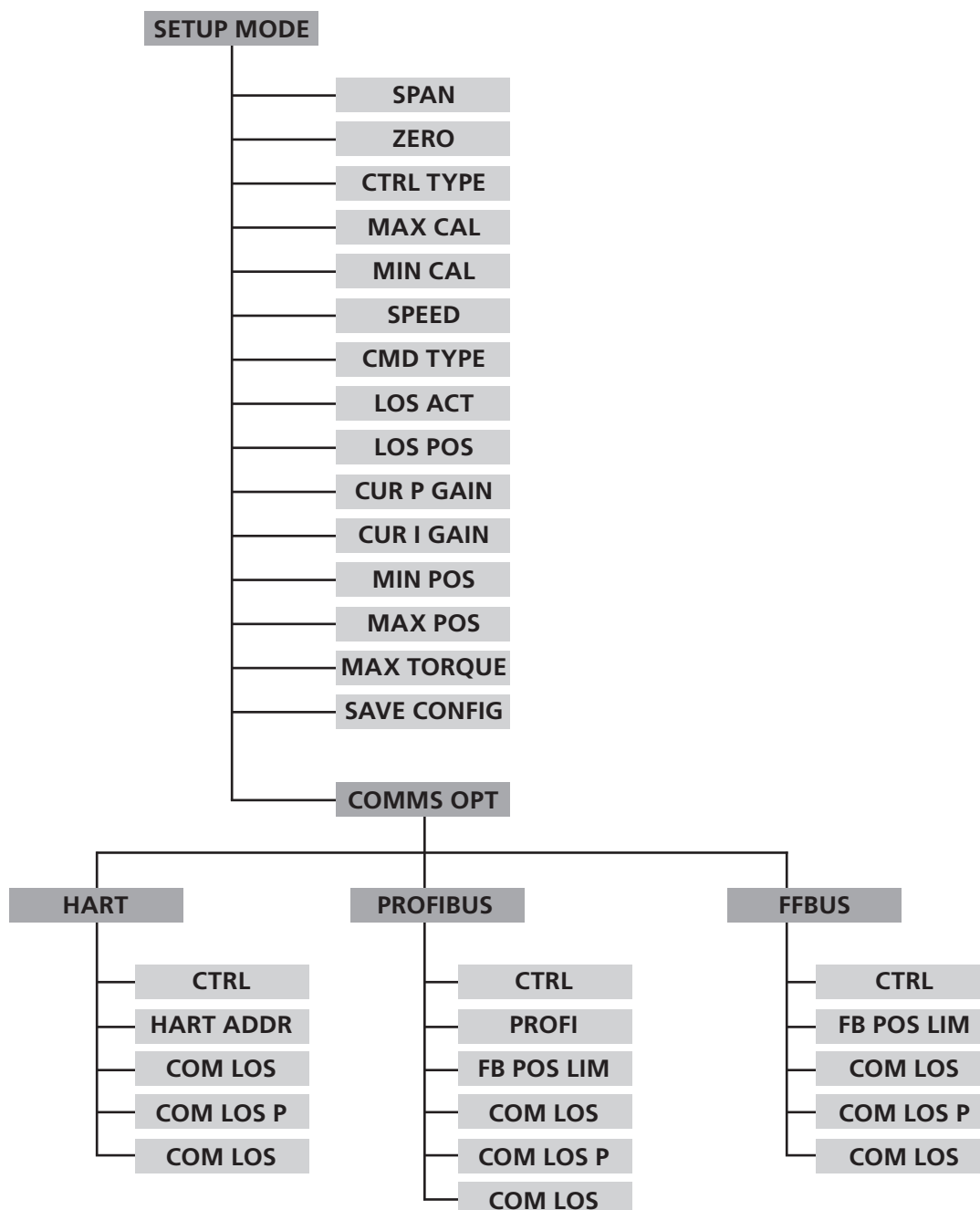

Figure 5.1. Level 1 Menu Structure

5.1 - Setup and Calibration - Level 1



WARNING: SETTING THE OUTPUT TORQUE HIGHER THAN 100% RATED MAY RESULT IN DAMAGE TO THE ACTUATOR AND OR LINKAGE.



CAUTION: OPERATION AND CALIBRATION OF THE UNIT MAY BE AFFECTED.



WARNING! ACTUATOR OUTPUT SHAFT MAY MOVE DURING LEVEL 1 SETUP.

NOTE:

CYCLING THE POWER TO THE ACTUATOR AT THIS STAGE WILL REMOVE RECENT CHANGES.

TO AVOID LOSS OF SETTINGS USE UP/DOWN KNOB TO SCROLL TO THE 'SAVE CONFIG' MENU.

LEVEL 1

SPAN

Used to set the maximum travel limit of the actuator.

ZERO

Used to set the minimum travel limit of the actuator.

CTRL TYPE

Used to set the control mode of the actuator.

M = Manual Mode (Fig. 5.2).

Actuator can be operated by using the UP/DOWN selector knob.

A = Automatic Mode (Fig. 5.3).

Actuator responds to hardwired remote control inputs only.

R = Remote Communications Mode (Fig. 5.4).

Actuator responds to serial commands when bus option cards are fitted.

S = Setup Mode (Fig. 5.5).

Allows access to menus and parameter changes.



Figure 5.2. Manual Mode



Figure 5.3. Automatic Mode



Figure 5.4. Remote Communications Mode



Figure 5.5. Setup Mode

5.1 - Setup and Calibration - Level 1 *cont.*

5.1.1 MAX CMD CAL

Used to calibrate the analogue command signal to the desired **SPAN** position.

This maximises resolution and optimises accuracy.

The analogue control signal should be applied to terminals as follows.

Voltage TB2-1 (+ve) TB2-2 (-ve)

Current TB2-4 (+ve) TB2-3 (-ve)

Refer to the identification label located on the outside of the actuator for wiring diagram details.

- 1 - Enter setup mode (see section 4.2).
- 2 - Use the **ENTER** knob to scroll through menus until 'MAX = XXXX' is displayed on line 2.
- 3 - Select 'ENTER'.

SET CMND TO MAX will appear on line 1 of the display.

4 - Apply the maximum input command e.g. 20 mA.

5 - Select 'ENTER' to accept the new Max Cal value,

Select 'CANCEL' to exit the Max Cal setup mode.

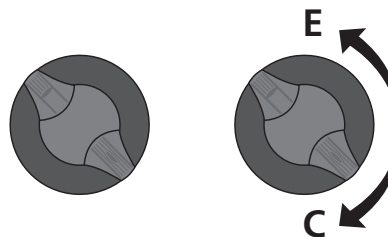

Figure 5.6. MAX CMD CAL

5.1.2 MIN CMD CAL

Used to calibrate the analogue command signal to the desired **ZERO** position.

This maximises resolution and optimises accuracy.

- 1 - Enter setup mode (see section 4.2).
- 2 - Use the 'Enter' knob to scroll through menus until 'ZERO = XXXX' is displayed on line 2.
- 3 - Select 'ENTER'.

SET CMND TO MIN will appear on line 1 of the display.

4 - Apply the minimum input command e.g. 4 mA.

5 - Select 'ENTER' to accept the new Min Cal value,

Select 'CANCEL' to exit the Min Cal setup mode.

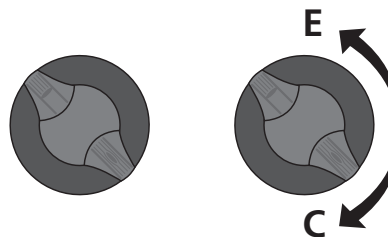

Figure 5.7. MIN CMD CAL

5.1 - Setup and Calibration - Level 1 *cont.*

5.1.3 SPEED

The actuator output speed is adjustable from 1 - 100% of its rated value.

- 1 - Enter setup mode (see section 4.2).
- 2 - Use the **UP/DOWN** knob to scroll through menus until 'Speed = XXX' appears on line 2 of the display.
- 3 - Select '**ENTER**'.
- 4 - Hold the **UP/DOWN** knob until desired value is displayed.
- 5 - Select '**ENTER**' to accept new Speed value, or select '**CANCEL**' to abort without changing the speed value.

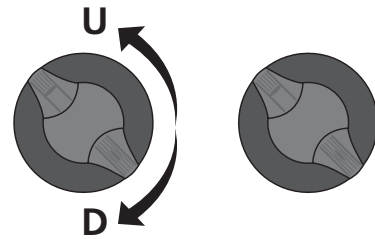

Figure 5.8. SPEED

5.1.4 CMD TYPE

Used to select between Current (4-20 mA) or Voltage (0-5 VDC or 0-10 VDC).

- 1 - Enter setup mode (see section 4.2).
 - 2 - Use **UP/DOWN** knob until 'COMMAND =XXXX' is displayed.
 - 3 - Select '**ENTER**'.
 - 4 - Use **UP/DOWN** knob to select Current or Voltage.
 - 5 - Select '**ENTER**' to accept the change.
- CANCEL** to exit the menu.

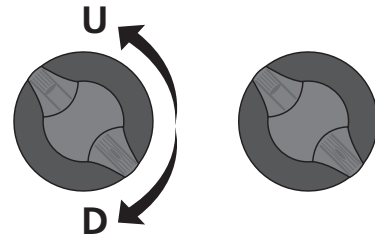

Figure 5.9. CMD TYPE

5.1.5 LOS ACT

Used to determine the actuator action on loss of analogue control signal when the actuator is set to Automatic Mode of operation.

LOCK - Stayput or Lock in place.
POS - Go to Preset Position.

- 1 - Enter setup mode (see section 4.2).
 - 2 - Use **UP/DOWN** knob until **LOS ACT** is displayed.
 - 3 - Select '**ENTER**'.
 - 4 - Use **UP/DOWN** knob to select desired value.
 - 5 - Select '**ENTER**' to accept the change.
- CANCEL** to exit the menu.

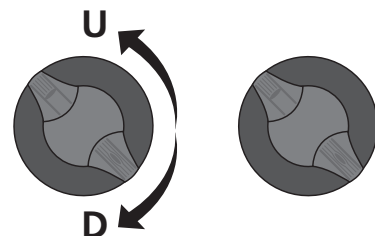

Figure 5.10. LOS ACT

5.1 - Setup and Calibration - Level 1 *cont.*

5.1.6 LOS POS

Used to determine the position that the actuator will move to on loss of analogue control signal.

- 1 - Enter setup mode (see section 4.2).
 - 2 - Use UP/DOWN knob until LOS POS is displayed.
 - 3 - Select 'ENTER'.
 - 4 - Use UP/DOWN knob to select desired value.
 - 5 - Select 'ENTER' to accept the change.
- CANCEL to exit the menu.

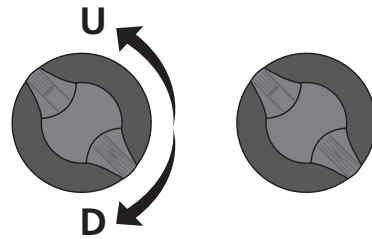

Figure 5.11. LOS POS

5.1.7 CUR P GAIN

Used to adjust the proportional gain of the actuator. Modifies the response of the actual position against desired position. Range 1-99.

- 1 - Enter setup mode (see section 4.2).
 - 2 - Use UP/DOWN knob until CUR P GAIN is displayed.
 - 3 - Select 'ENTER'.
 - 4 - Use UP/DOWN knob to select desired value.
 - 5 - Select 'ENTER' to accept the change.
- CANCEL to exit the menu.

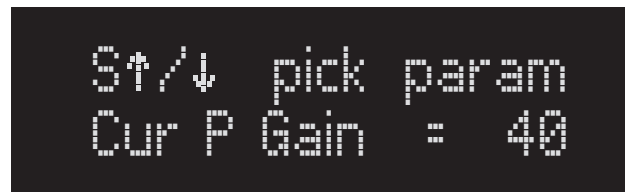
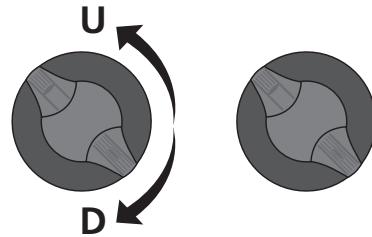

Figure 5.12. CUR P GAIN

5.1.8 CUR I GAIN

Used to adjust the integral gain of the actuator where system response varies over time. Range 0-99.

- 1 - Enter setup mode (see section 4.2).
 - 2 - Use UP/DOWN knob until CUR I GAIN is displayed.
 - 3 - Select 'ENTER'.
 - 4 - Use UP/DOWN knob to select desired value.
 - 5 - Select 'ENTER' to accept the change.
- CANCEL to exit the menu.

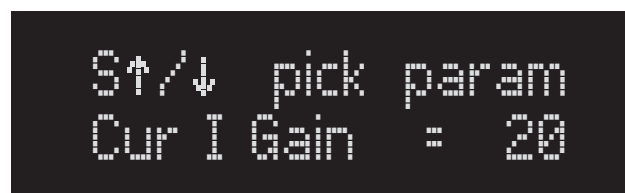
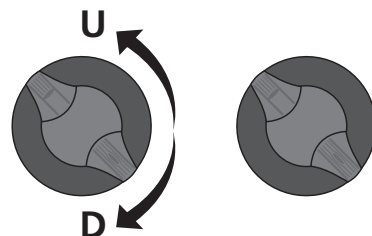
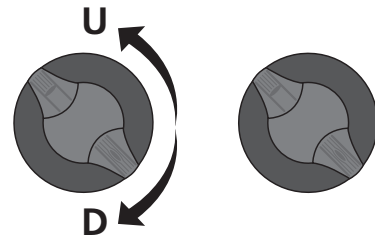

Figure 5.13. CUR I GAIN

5.1 - Setup and Calibration - Level 1 *cont.*



```
S↑/↓ pick param  
Min Pos = 0
```

Figure 5.14. MIN POS

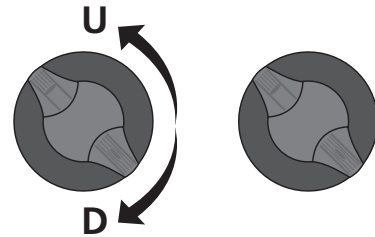

```
S↑/↓ pick param  
Min Pos = 100
```

Figure 5.15. MAX POS

5.1 - Setup and Calibration - Level 1 *cont.*

5.1.11 MAX TORQUE %

Used to limit the output torque produced by the actuator. Exceeding the value will result in an over torque alarm being displayed.

- 1 - Enter setup mode (see section 4.2).
- 2 - Use UP/DOWN knob until **Max TORQUE** is displayed.
Max value = 200% of rated,
- 3 - Select 'ENTER'
- 4 - Use UP/DOWN knob to select desired value.
- 5 - Select 'ENTER' to accept the change.

CANCEL to exit the menu.

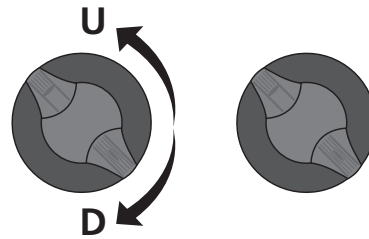

Figure 5.16. MAX TORQUE %

5.1.12 SAVE CONFIG

Used to save setup parameters to EEPROM. Any parameter changes **MUST** be saved prior to power off. On power up the on board processor will use the last values stored in the EEPROM.

- 1 - Enter setup mode (see section 4.2).
- 2 - Use UP/DOWN knob until **SAVE CONFIG** is displayed.
- 3 - Select 'ENTER' to save changes to EEPROM.

CANCEL to exit the menu.

SETUP COMPLETE

Set the AUTO/MANUAL parameter to AUTO.

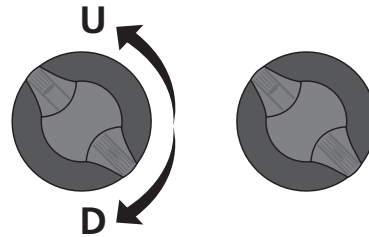

Figure 5.17. SAVE CONFIG

5.2 - Communications

COMMS OPT

Used to select specific menus when a **BUS** communications option card is fitted.

- 1 - Enter setup mode (see section 4.2).
- 2 - Use **UP/DOWN** knob until **COMS OPT** is displayed.
- 3 - Select '**ENTER**'.

- 4 - Use **UP/DOWN** knob to select the actuator control protocol.

Choices are

- NONE** No Bus Protocol option fitted.
- HART**
- PROFIBUS**
- FFBUS** (Foundation Fieldbus)

- 5 - Select '**ENTER**' to accept the change.

The selected communication protocol options will now be available.

Note that the unit must be fitted with the appropriate Bus system card to support the menus.

5.2.1 HART CONTROL OPTIONS

CTRL MECH

The actuator can be controlled via commands received over the Hart protocol communications channel or as a direct analogue (4-20 mA) input signal request.

- 1 - Enter setup mode (see section 4.2).
- 2 - Use **UP/DOWN** knob until **CTRL MECH** is displayed.
- 3 - Select '**ENTER**'.
- 4 - Use **UP/DOWN** knob to select the actuator control type.

Menu choices are:

- COMMS** = HART protocol control
- ANALOG** = 4-20 mA Analogue Control only.

- 5 - Select **ENTER** to accept the change.

CANCEL to exit the menu.

HART ADDR

Used to set the address assigned to the device on the HART network. Range 1 to 64.

- 1 - Enter setup mode (see section 4.2).
- 2 - Use **UP/DOWN** knob until **HART ADDR** is displayed.
- 3 - Select '**ENTER**'.
- 4 - Use **UP/DOWN** knob until desired address is displayed
- 5 - Select '**ENTER**'.

CANCEL to exit the menu.

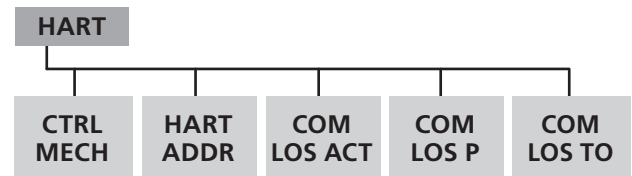

Figure 5.18

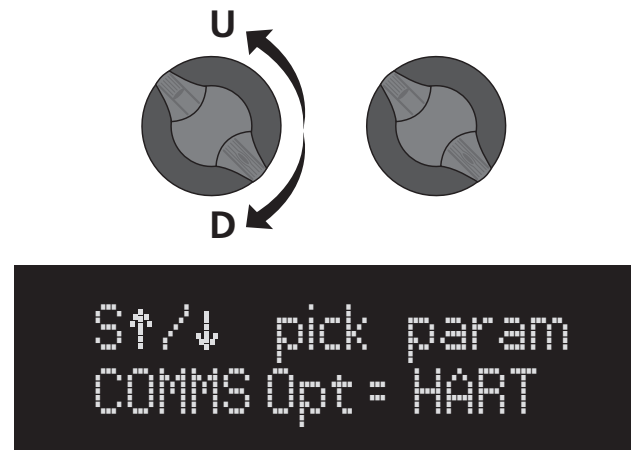

Figure 5.19. COMMS OPT

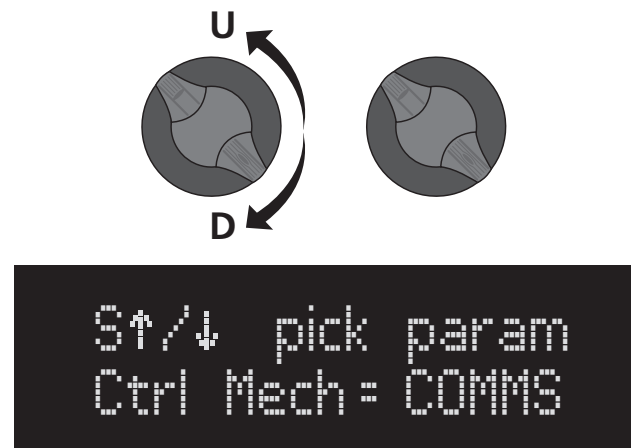

Figure 5.20. CTRL MECH

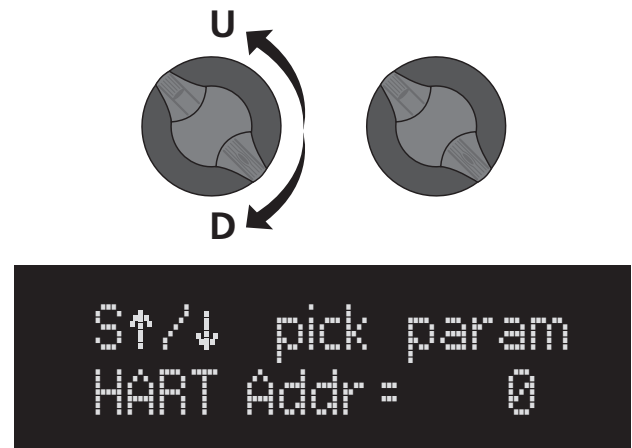

Figure 5.21. HART ADDR

5.2 - Communications *cont.*

COM LOS ACT

Action on loss of HART communication.

- 1 - Enter setup mode (see section 4.2).
- 2 - Use UP/DOWN knob until COM LOS ACT is displayed.
- 3 - Select 'ENTER'.
- 4 - Use UP/DOWN knob to select the desired action.

Menu choices are:

LOCK - Stayput or Lock in place.

POS - Go to Preset Position.

- 5 - Select 'ENTER' to accept the change.

CANCEL to exit the menu.

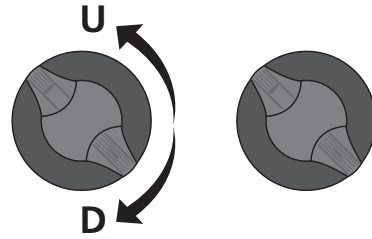

```
S↑/↓ pick param
COM LOS Act = Stop
```

Figure 5.22. LOS POS

COMM LOS P

Position actuator will move to on loss of HART communication.

- 1 - Enter setup mode (see section 4.2).
- 2 - Use UP/DOWN knob until COM LOS P is displayed.
- 3 - Select 'ENTER'.
- 4 - Use UP/DOWN knob to select the desired position.

Range 0-100%.

- 5 - Select 'ENTER' to accept the change.

CANCEL to exit the menu.

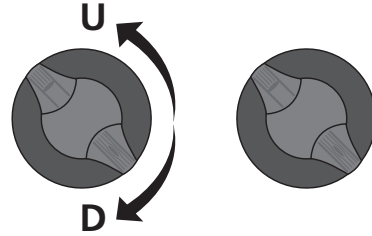

```
S↑/↓ pick param
COMS LOS P = 781
```

Figure 5.23. CUR P GAIN

COMM LOS TO

Time delay before action is taken on loss of HART communication. Maximum of 10 seconds.

- 1 - Enter setup mode (see section 4.2).
- 2 - Use UP/DOWN knob until COM LOS TO is displayed.
- 3 - Select 'ENTER'.
- 4 - Use UP/DOWN knob to select the desired delay time.
- 5 - Select 'ENTER' to accept the change.

CANCEL to exit the menu.

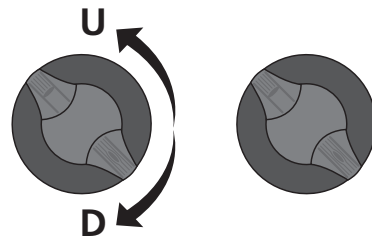

```
S↑/↓ pick param
COMS LOS TO = 63
```

Figure 5.24. CUR I GAIN

NOTE: To avoid loss of settings use the 'SAVE CONFIG' menu to save changes to the EEPROM. See p42 for details.

5.2 - Communications *cont.*

5.2.2 PROFIBUS CONTROL OPTIONS

CTRL MECH

The actuator can be controlled via commands received over the Profibus protocol communications channel or as a direct analogue (4-20 mA) input signal request.

- 1 - Enter setup mode (see section 4.2).
- 2 - Use **UP/DOWN** knob until **CTRL MECH** is displayed.
- 3 - Select '**ENTER**'.
- 4 - Use **UP/DOWN** knob to select the actuator control type.

Menu choices are:

COMMS = Profibus protocol control

ANALOG = 4-20 mA Analogue Control only.

- 5 - Select '**ENTER**' to accept the change.

CANCEL to exit the menu.

PROFI ADDR

Used to set the address assigned to the device on the Profibus network. Range 1 to 127.

- 1 - Enter setup mode (see section 4.2).
- 2 - Use **UP/DOWN** knob until **PROFI ADDR** is displayed.
- 3 - Select '**ENTER**'.
- 4 - Use **UP/DOWN** knob until desired address is displayed.
- 5 - Select '**ENTER**'.

CANCEL to exit the menu.

FB POS LIMIT

Feedback position limiting. When enabled the actuator will return a zero value when the actuator is below the **MIN POS** limit and 100% above the **MAX POS** Limit.

- 1 - Enter setup mode (see section 4.2).
- 2 - Use **UP/DOWN** knob until **FB POS LIMIT** is displayed.
- 3 - Select '**ENTER**'.
- 4 - Use **UP/DOWN** to select Enable or Disable function.
- 5 - Select '**ENTER**'.

CANCEL to exit the menu.

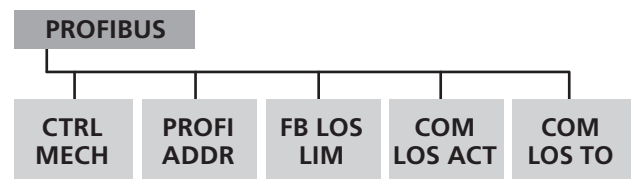

Figure 5.25

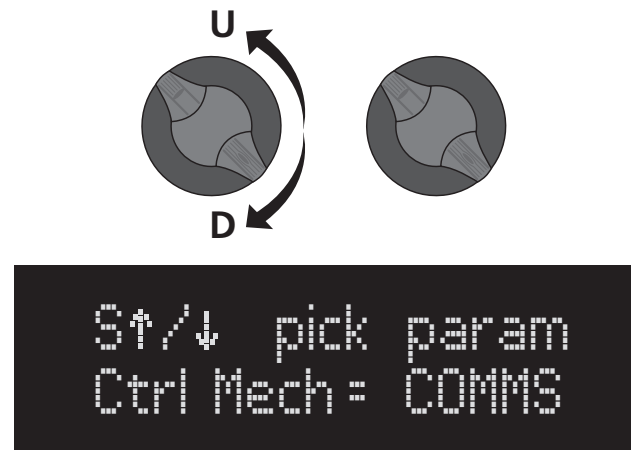

Figure 5.26. CTRL MECH

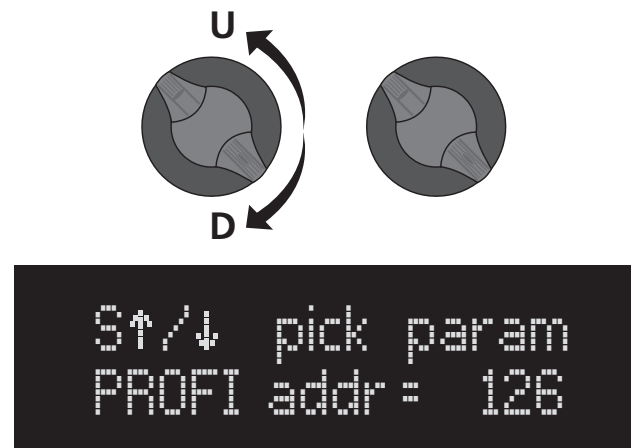

Figure 5.27. PROFI ADDR

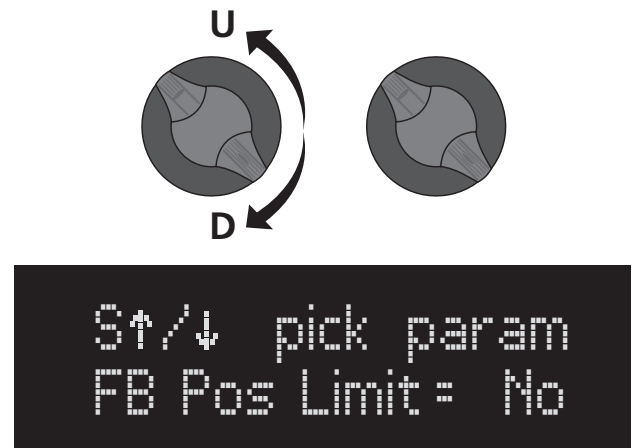

Figure 5.28. POS LIMIT

5.2 - Communications *cont.*

COM LOS ACT

Action on loss of Profibus communication.

- 1 - Enter setup mode (see section 4.2).
- 2 - Use UP/DOWN knob until COM LOS ACT is displayed.
- 3 - Select 'ENTER'.
- 4 - Use UP/DOWN knob to select the desired action.

Menu choices are:

LOCK - Stayput or Lock in place.

POS - Go to Preset Position.

- 5 - Select 'ENTER' to accept the change.

CANCEL to exit the menu.

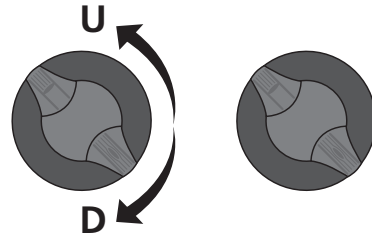

```
S↑/↓ pick param
COM LOS Act = Stop
```

Figure 5.29. COM LOS POS

COMM LOS P

Position actuator will move to on loss of Profibus communication.

- 1 - Enter setup mode (see section 4.2).
- 2 - Use UP/DOWN knob until COMM LOS P is displayed.
- 3 - Select 'ENTER'.
- 4 - Use UP/DOWN knob to select the desired position.

Range 0-100%.

- 5 - Select 'ENTER' to accept the change.

CANCEL to exit the menu.

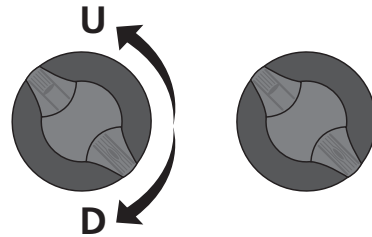

```
S↑/↓ pick param
COMM LOS P = 781
```

Figure 5.30. COMM LOS P

COMM LOS TO

Time delay before action is taken on loss of Profibus communication. Maximum of 10 seconds.

- 1 - Enter setup mode (see section 4.2).
- 2 - Use UP/DOWN knob until COMM LOS TO is displayed.
- 3 - Select 'ENTER'.
- 4 - Use UP/DOWN knob to select the desired delay time.

- 5 - Select 'ENTER' to accept the change.

CANCEL to exit the menu.

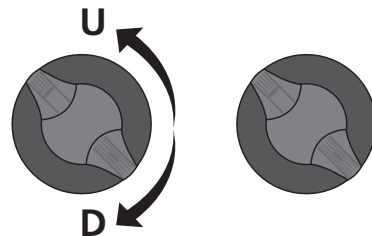

```
S↑/↓ pick param
COMM LOS TO = 255
```

Figure 5.31. COMM LOS TO

NOTE: To avoid loss of settings use the 'SAVE CONFIG' menu to save changes to the EEPROM. See p42 for details.

5.2 - Communications *cont.*

5.2.3 FOUNDATION FIELDBUS CONTROL OPTIONS

CTRL MECH

The actuator can be controlled via commands received over the FFBUS protocol communications channel or as a direct analogue (4-20 mA) input signal request.

- 1 - Enter setup mode (see section 4.2).
- 2 - Use **UP/DOWN** knob until **CTRL MECH** is displayed.
- 3 - Select '**ENTER**'.
- 4 - Use **UP/DOWN** knob to select the actuator control type.

Menu choices are:

COMMS = FFBUS protocol control.

ANALOG = 4-20 mA Analogue Control only.

- 5 - Select '**ENTER**' to accept the change.

CANCEL to exit the menu.

FB POS LIMIT

Feedback position limiting. When enabled the actuator will return a zero value when the actuator is below the **MIN POS** limit and 100% above the **MAX POS** Limit.

- 1 - Enter setup mode (see section 4.2).
- 2 - Use **UP/DOWN** knob until **FB POS LIMIT** is displayed.
- 3 - Select '**ENTER**'.
- 4 - Use **UP/DOWN** to select Enable or Disable function.
- 5 - Select '**ENTER**'.

CANCEL to exit the menu.

COM LOS ACT

Action on loss of Foundation Fieldbus communication.

- 1 - Enter setup mode (see section 4.2).
- 2 - Use **UP/DOWN** knob until **COM LOS ACT** is displayed.
- 3 - Select '**ENTER**'.
- 4 - Use **UP/DOWN** knob to select the desired action.

Menu choices are:

LOCK - Stayput or Lock in place.

POS - Go to Preset Position.

- 5 - Select '**ENTER**' to accept the change.

CANCEL to exit the menu.

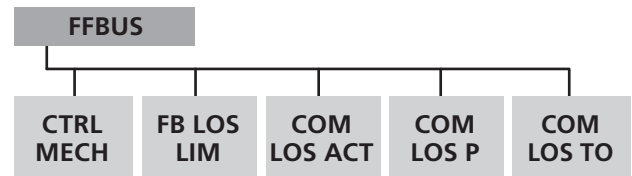

Figure 5.32

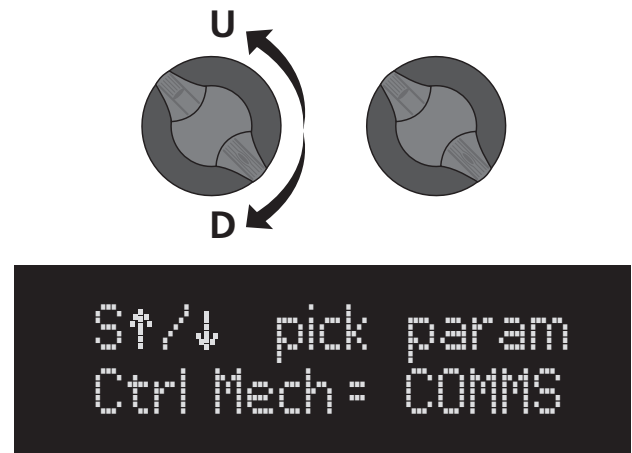

Figure 5.33. CTRL MECH

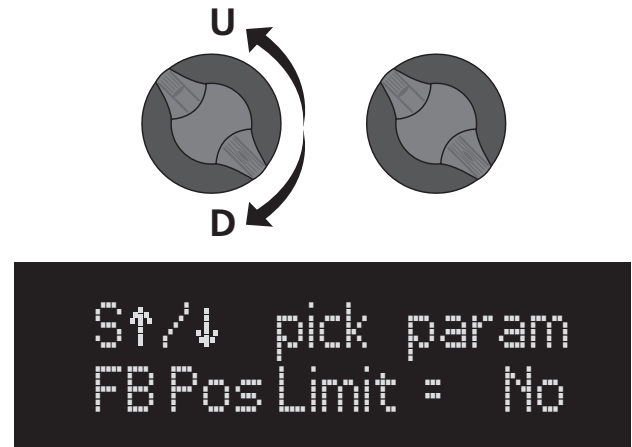

Figure 5.34. FN POS LIMIT

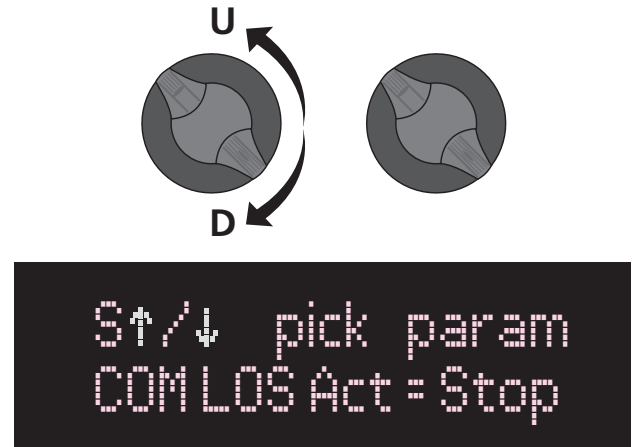

Figure 5.35. COM LOS POS

5.2 - Communications *cont.*

COMM LOS P

Position actuator will move to on loss of FFBUS communication.

- 1 - Enter setup mode (see section 4.2).
- 2 - Use UP/DOWN knob until **COM LOS P** is displayed.
- 3 - Select 'ENTER'
- 4 - Use UP/DOWN knob to select the desired position.

Range 0-100%.

- 5 - Select 'ENTER' to accept the change.

CANCEL to exit the menu.

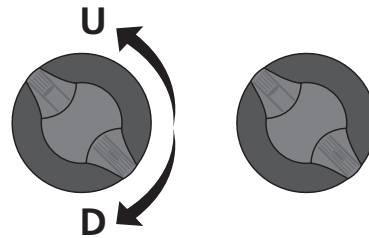

Figure 5.36. COMM LOS P

COMM LOS TO

Time delay before action is taken on loss of FFBUS communication. Maximum of 10 seconds.

- 1 - Enter setup mode (see section 4.2).
- 2 - Use UP/DOWN knob until **COM LOS TO** is displayed.
- 3 - Select 'ENTER'.
- 4 - Use UP/DOWN knob to select the desired delay time.
- 5 - Select 'ENTER' to accept the change.

CANCEL to exit the menu.

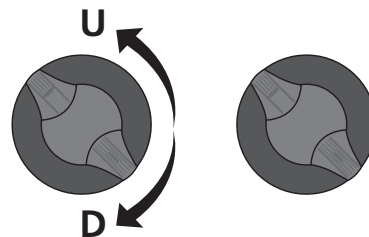

Figure 5.37. COMM LOS TO

NOTE: To avoid loss of settings use the 'SAVE CONFIG' menu to save changes to the EEPROM. See p42 for details.

RECORD YOUR USER SETTINGS IN SECTION 13.

5.3 - Setup and Calibration - Level 2

SM-6000 S2 MENU STRUCTURE

Level 2: Diagnostic and Advanced Settings.
User may wish to consult Rotork Controls
before making changes to level 2 parameters.

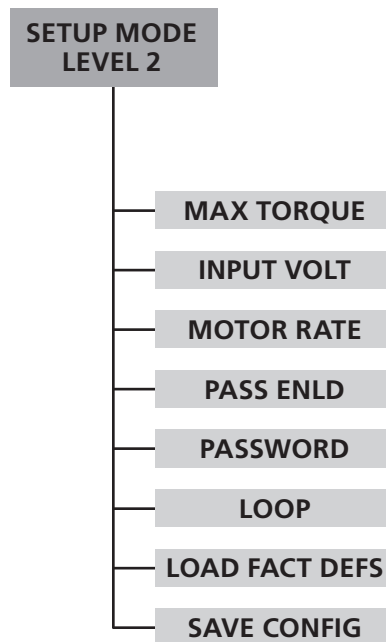

Figure 5.38. Level 2 Menu Structure

5.3 - Setup and Calibration - Level 2 *cont.*

LEVEL 2 ADVANCED SETUP MENUS

 **CAUTION: SOME VARIABLES IN LEVEL 2 ARE FACTORY SET – DO NOT ADJUST!!**

To access the advanced setup and calibration menus rotate the UP/DOWN knob clockwise and the ENTER/CANCEL knob anti-clockwise.

Hold for 10 seconds.

5.3.1 MAX TORQUE

Used to match the motor output and control to the gearbox.

This value is factory set and must not be changed.

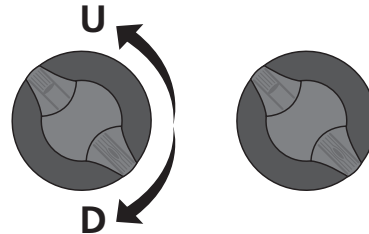

```
S↑/↓ pick param
Max Torq % = 100
```

Figure 5.39. MAX TORQUE

5.3.2 INPUT VOLT

Used to select the AC input voltage used by the Amplifier. Check the actuator wiring diagram for additional notes on selection of input power supplies.

This must match the hardware configuration. This value is factory set and must not be changed.

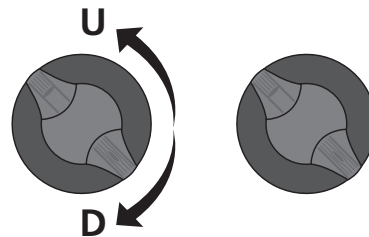

```
S↑/↓ pick param
Input Volt = 120
```

Figure 5.40. INPUT VOLT

5.3.3 PASS ENBLD

Enable a 4 Digit system password. Select 'YES' to enable password..

PASSWORD VALUE

Check function

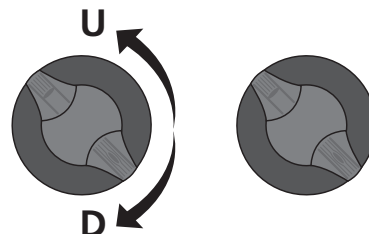

```
S↑/↓ pick param
Pass Enbl'd = No
```

Figure 5.41. PASS ENBLD

5.3 - Setup and Calibration - Level 2 *cont.*

5.3.4 LOOP

Closed loop or Open loop control. The default setting of the actuator is Closed loop control. Open loop is used for factory setup only.

This value is factory set and must not be changed.

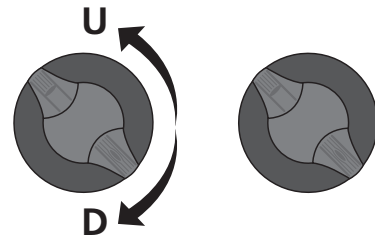

Figure 5.42. LOOP

5.3.3 LOAD FACT DEFS

Used to revert the actuator back to the Factory default Settings.

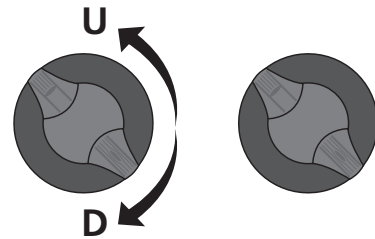

Figure 5.43. LOAD FACT DEFS



CAUTION: SAVE CONFIG

Used to save setup parameters to EEPROM. Any parameter changes **MUST** be saved prior to power off. On power up the onboard processor will use the last values stored in the EEPROM.

Use UP/DOWN knob until SAVE CONFIG is displayed.

Select 'ENTER' to save changes to EEPROM.

CANCEL to exit the menu.

SETUP COMPLETE

RECORD YOUR USER SETTINGS IN SECTION 13.

6 - Faults & Troubleshooting

6.1 FAULT STATUS INDICATION

Fault Diagnostics appear on line two of the display. When more than one diagnostic is active, only the highest priority will show.

Flt: Incr Limit

End of Travel Limit Switch for the increasing direction is tripped.

Decrease actuator position to move off limit switch.

Flt: Decr Limit

End of Travel Limit Switch for the decreasing direction is tripped.

Increase actuator position to move off limit switch.

Flt: Stalled

Actuator output speed is incorrect due to excessive load.

Momentary stall Flts are self-resetting.

Continuous or repetitive stall Flts indicate an improperly loaded actuator. Reduce load.

Flt: LOS-Command

Loss of command signal.

Command signal is below 3.6 mA, or above 21.6 mA.

Return command signal to 4-20 mA range.

Flt: Crnk Engagd

The hand crank has been engaged.

Pull out hand crank to remove Ft.

Flt: LOS-Feedbk

If using an encoder, either the encoder is disconnected, the encoder has reached the end of travel, or there is an internal encoder fault.

If using a potentiometer, the feedback pot has been disconnected or the feedback signal has risen above 4.9 V.

Flt: System Fail

Microprocessor has detected a system failure.

Simultaneously turn the UP/DOWN knob ACW and ENTER/CANCEL knob CW to Clear the alarm.

Flt: Torq Limit

The current rating of the torque has been exceeded.

Simultaneously turn the UP/DOWN knob ACW and ENTER/CANCEL knob CW to Clear the alarm.

Flt: Mtr Pol Re

Motor direction of operation or response is incorrect.

Motor leads possibly reversed.

Switch off and check motor wiring immediately!

Motor operation is checked automatically on power up.

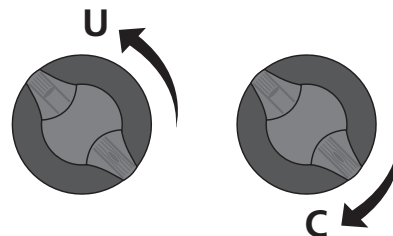

Figure 6.1. Turn both knobs as shown to clear alarms.

6 - Faults & Troubleshooting *cont.*

6.2 Troubleshooting

Trouble	Possible Cause	Remedy
Actuator will increase position but not decrease	LS2 is tripped	Increase actuator to normal operating range. Check LS2 and Zero Setup
	Actuator is at zero position	
Actuator will decrease position, but not increase	LS1 is tripped	Decrease actuator to normal operating range. Check LS2 and SPAN Setup
Actuator will not move	No actuator power	Is LED D1 on? If no, turn off electrical power and re-check electrical connections
	Motor is not connected	Connect motor as shown in the wiring diagram
	LS1 and LS2 are both tripped	Verify LS1 and LS2 are setup correctly
	Hand Crank engaged	Remove hand crank engagement
Actuator oscillates during movement	Too high of proportional gain	Reduce Cur P gain/CL gain
Actuator overshoots position	Too high of integral gain	Reduce Cur I gain
Poor response to command signal change	Too low of proportional gain	Increase Cur P/CL gain
	Amplifier defective	Replace amplifier
	Excessive noise on command signal	Reduce noise. Also ensure that command signal wiring is shielded with shield grounded at source common only
Actuator moves, but motor gets hot	Motor brake not disengaging	Verify motor brake wiring
	Motor brake module not setup	Set per wiring diagram
	Motor brake module defective	replace phase control module
Actuator does not respond to a change in command	Wrong command type selected	Verify current/voltage setup for command
	Wiring disconnected	Verify electrical connection
	Actuator in Manual	Place actuator in automatic
Actuator will not move and has lost feedback	Feedback element is disconnected	Check feedback device connection
	Actuator position is out of operating range	Hand crank actuator to operating range
Nothing on Display	No Power to control/logic board	Is LED D1 on? If no, turn off electrical power and re-check electrical connections
	Amplifier defective	Replace amplifier
	No power to Transmitter	Transmitter is loop powered. See wiring diagram to supply isolated power to transmitter
	Incorrect wiring	Verify electrical connections
	Transmitter ID defective	Replace transmitter
D7 fault is on	A fault had occurred	See diagnostics on Page 15
Motor Runs but output shaft does not rotate	Motor Coupling defective	Verify connection between motor and gear box
Actuator Back drives when power is removed	Holding brake improperly adjusted	Adjust spring force on holding brake
	Holding brake worn	Replace holding brake
	Too heavy of a load	Verify rating and load
Hand crank does not move output shaft	Hand crank not engaged fully	Verify hand crank couples with motor shaft
	Hand crank retaining Pin worn or broken	Verify retaining pin
	Motor coupling defective	Verify connection between motor and gearbox

7 - Manual Operation - Handcrank Direction

Speed/Torque	Rotation of Handcrank	Rotation of Output Shaft (looking at the end of the output shaft)
10/370	CW	CW
10/550	CW	CW
10/800	CW	CW
10/1400	CW	CW
10/2500	CW	CW
10/4400	CW	CW
10/6200	CW	CCW
12/8000	CW	CCW
18/11000	CW	CCW
26/16500	CW	CCW
42/26000	CW	CCW

8 - Mounting Conversion

To convert a Horizontally mounted SM-6000 to a vertically mounted SM-6000:

- Unthread the existing breather located near the top surface of the gearbox.
- Add additional lubricant per the chart below (see list of approved lubricants).
- While holding a finger over the breather opening tip the gearbox to the vertical position.
- Remove the existing tapped plug that is at the highest point on the gearbox when in the vertical position.
- Quickly install the tapped plug into the lower location. Fully tighten.
- Thread breather into the upper opening. Fully tighten.

On the 5 largest units with two reservoirs relocate the breathers from both reservoirs as noted above.

To convert a Vertical SM-6000 to a Horizontal SM-6000 follow same steps but do not remove lubricant.

Approved Lubricants

- Castrol Isolube EP220
- Mobil Omala 220 HD
- Kluber Klubersynth EG 4-220
- Tribol 1510/220

Speed/Torque	Large Reservoir		Small Reservoir	
	English	Metric	English	Metric
10/370	0.85 qts. (27.2 fl.oz)	0.8 ltr.	NA	NA
10/550	0.85 qts. (27.2 fl.oz)	0.8 ltr.	NA	NA
10/800	1.6 qts. (51.2 fl.oz)	1.5 ltr.	NA	NA
10/1400	0.8 qts. (25.6 fl.oz)	0.8 ltr.	NA	NA
10/2500	2.2 qts. (70.4 fl.oz)	2.1 ltr.	NA	NA
10/4400	4.4 qts. (140.8 fl.oz)	4.2 ltr.	NA	NA
10/6200	4.2 qts. (134.4 fl.oz)	4 ltr.	0.11 qts. (3.5 fl.oz)	0.1 ltr.
12/8000	9.5 qts. (304 fl.oz)	9 ltr.	0.53 qts. (17 fl.oz)	0.5 ltr.
18/11000	9.5 qts. (304 fl.oz)	9 ltr.	0.53 qts. (17 fl.oz)	0.5 ltr.
26/16500	18.0 qts. (576 fl.oz)	17 ltr.	0.64 qts. (20.5 fl.oz)	0.6 ltr.
42/26000	21 qts. (672 fl.oz)	20 ltr.	0.64 qts. (20.5 fl.oz)	0.6 ltr.

9 - Parts Identification

370, 800 & 1400 ft. lb. units

Item	Part Number	Description
1	23B-043132-001	0.5 hp Motor
2	61A-040848-001	Spacer
3	61B-040853-001	Base, housing
4	60A-040851-001	Cover
5	61A-040847-001	Handcrank shaft
6	61A-040850-001	Switch plate
7	60B-040852-001	Handcrank
8	18B-SP1988-097	Bushing
9	19B-003815-017	Seal
10	61A-040932-002	Gasket
11	46A-040825-001	Switch
12	74B-010957-156	O-Ring
13	47A-007639-001	Handle
14	18B-SP1988-085	Bushing
15	68B-040940-002	Brake assembly
16	20A-040878-003	Spring
17	58B-024244-479	Washer

Recommended spare parts are bold

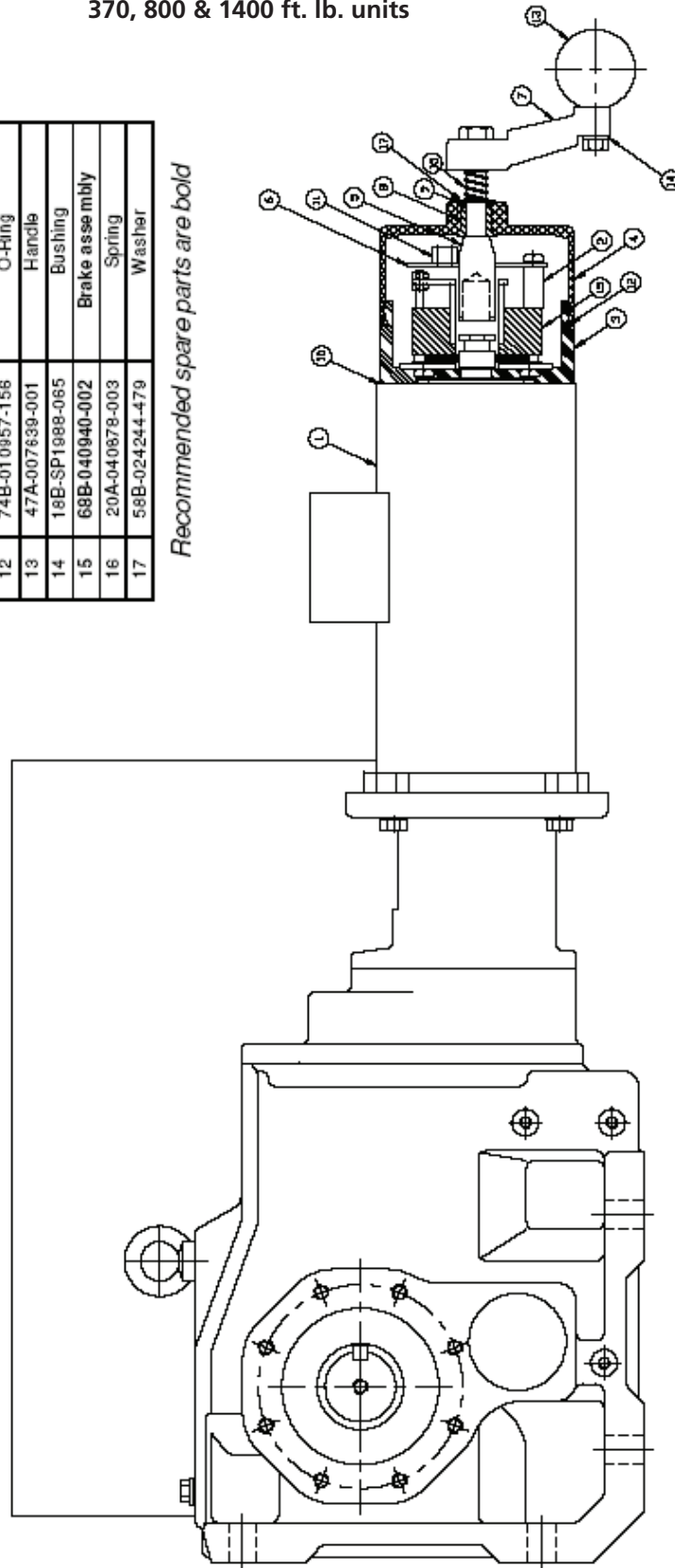

9 - Parts Identification *cont.*

2500 ft. lb. unit

Item	Part Number	Description
1	23C-041665-001	1 hp Motor
2	61A-040848-001	Spacer
3	61B-040853-001	Base, housing
4	60A-040851-001	Cover
5	61A-040847-001	Handcrank shaft
6	61A-040850-001	Top switch plate
7	68B-040773-001	Handcrank
8	18B-SP1988-097	Bushing
9	19B-003815-017	Seal
10	61A-040932-001	Gasket
11	46A-040925-001	Switch
12	74B-010957-156	O-Ring
13	74A-014614-001	Handle
14	18B-SP1988-065	Bushing
15	22B-041126-001	Brake
16	20A-040878-003	Spring
17	58B-024244-479	Washer

Recommended spare parts are bold

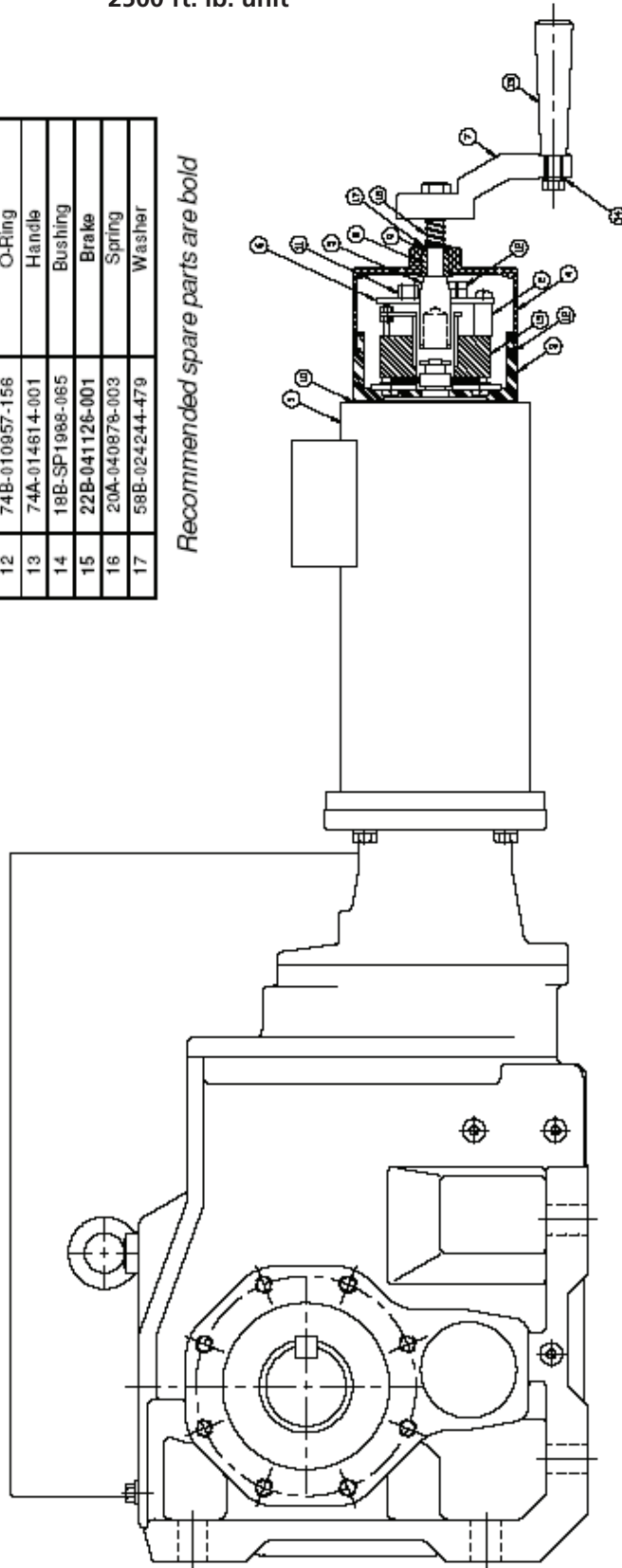

9 - Parts Identification *cont.*

4400, 6200, 8000, 11000, 16500, & 26000 ft. lb. units

Item	Part Number	Description
1	23C-041666-001	2 hp Motor
2	61A-040947-001	Spacer
3	61C-040942-001	Base, housing
4	60C-040943-001	Cover
5	61A-040947-001	Handcrank shaft
6	61A-040944-001	Switch plate
7	60B-040945-001	Handcrank
8	18B-SP1988-097	Bushing
9	19B-003815-017	Seal
10	61A-040932-002	Gasket
11	46A-040925-001	Switch
12	74B-004108-001	O-Ring
13	74A-014614-001	Handle
14	18B-SP1988-065	Bushing
15	22B-040946-001	Brake assembly
16	20A-040878-005	Spring
17	58B-024244-479	Washer

Recommended spare parts are bold

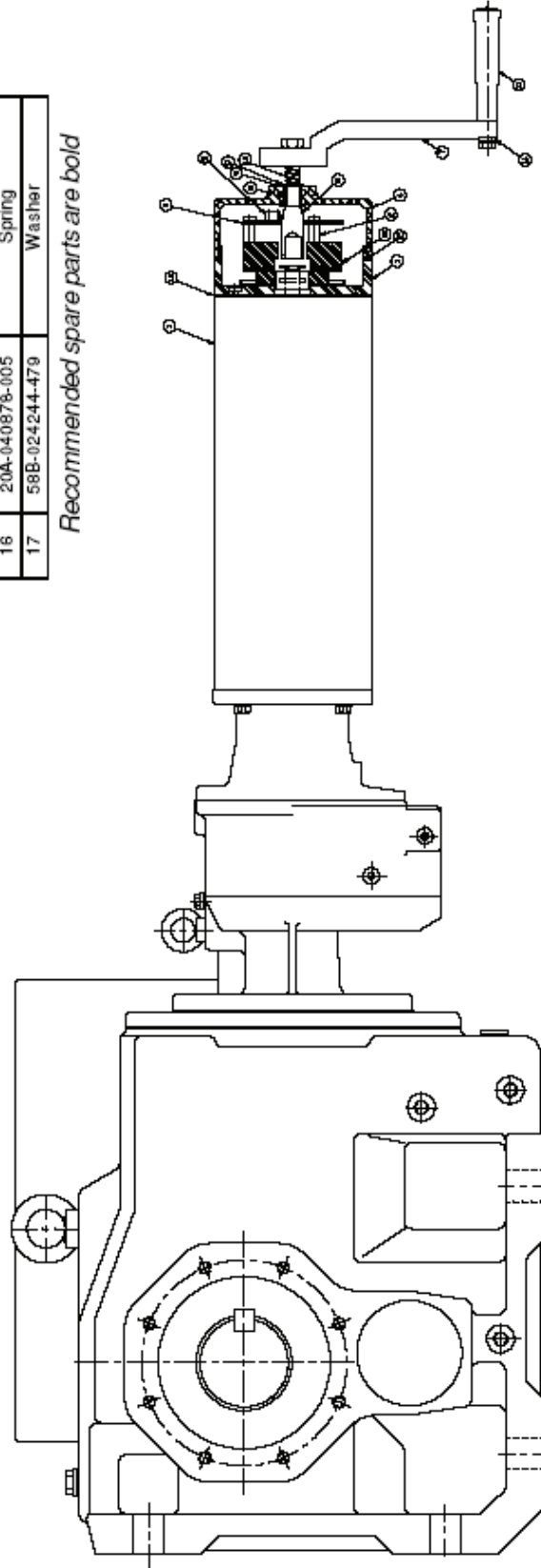

10 - Drive Arm Dimensions

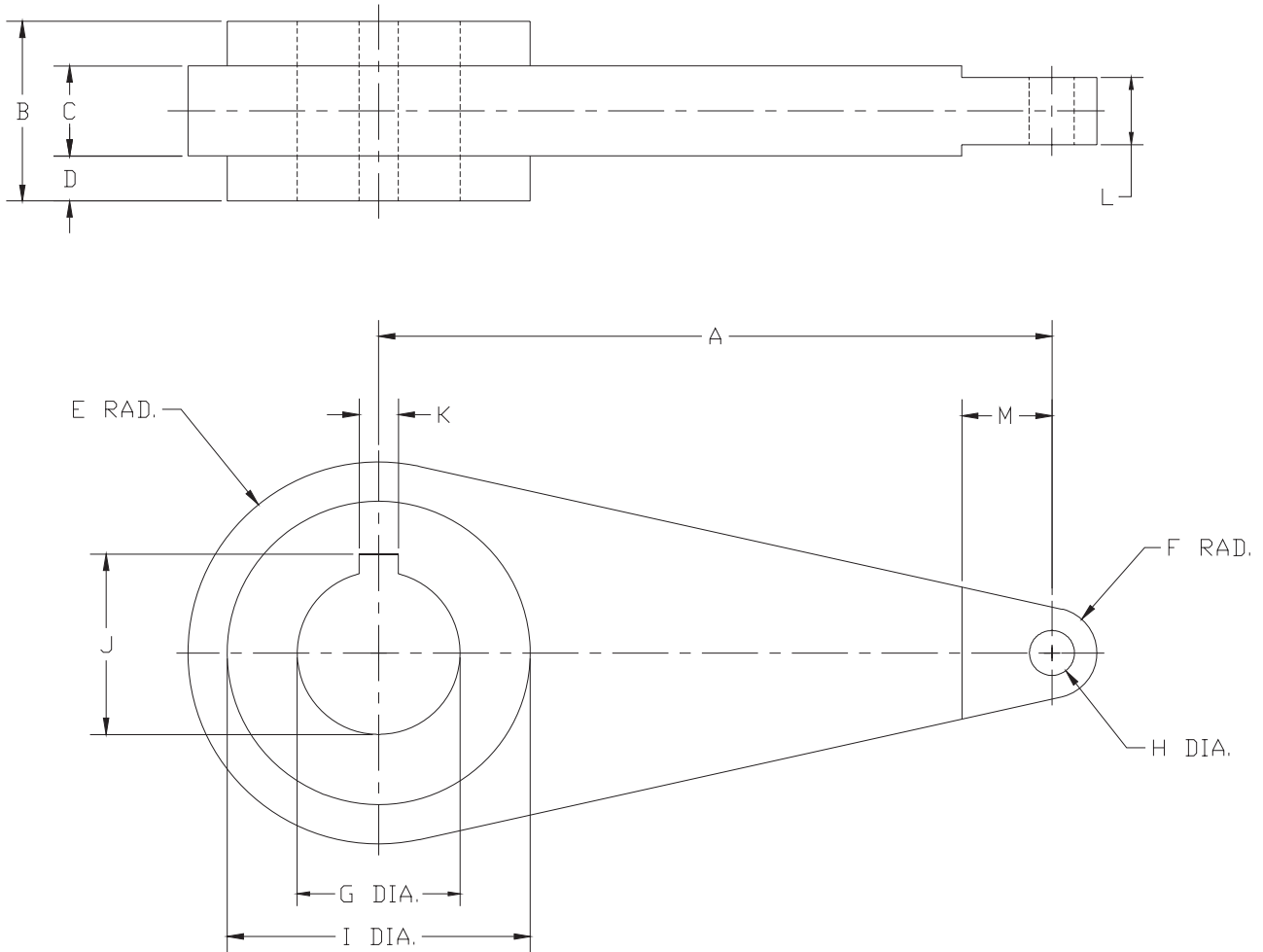

Speed/Torque	A	B	C	D	E	F	G	H	I	J	K	L	M
10/370	10.00	1.00	-	-	1.08	.75	1.25	.75	-	1.39	.25	1.00	-
10/800	10.00	1.50	-	-	1.50	1.00	1.38	1.00	-	1.54	.31	1.50	-
10/1400	10.00	1.50	-	-	1.50	1.00	1.75	1.00	-	1.95	.38	1.50	-
10/2500	12.00	2.50	1.50	.50	2.63	1.00	2.38	1.00	4.50	2.68	.63	1.50	-
10/4400	12.00	2.50	1.50	.50	2.63	1.00	2.88	1.00	4.50	3.23	.75	1.50	-
10/6200	15.00	4.00	2.00	1.00	4.25	1.00	3.63	1.00	6.75	4.04	.88	1.50	2.00
12/8000 & 18/11,000	15.00	4.00	2.00	1.00	4.25	1.00	4.38	1.00	6.75	4.85	1.00	1.50	2.00
26/16,500	15.00	4.00	2.00	1.00	4.25	1.00	4.75	1.00	6.75	5.33	1.25	1.50	2.00
42/26,000	18.00	5.00	2.00	1.50	4.63	1.50	5.50	1.25	7.75	6.08	1.25	2.00	-

These dimensions are subject to change without notice and should not be used for preparation of drawings or fabrication of installation mounting. For current installation manuals and other product information, see www.rotork.com.

11 - Overall Dimensions

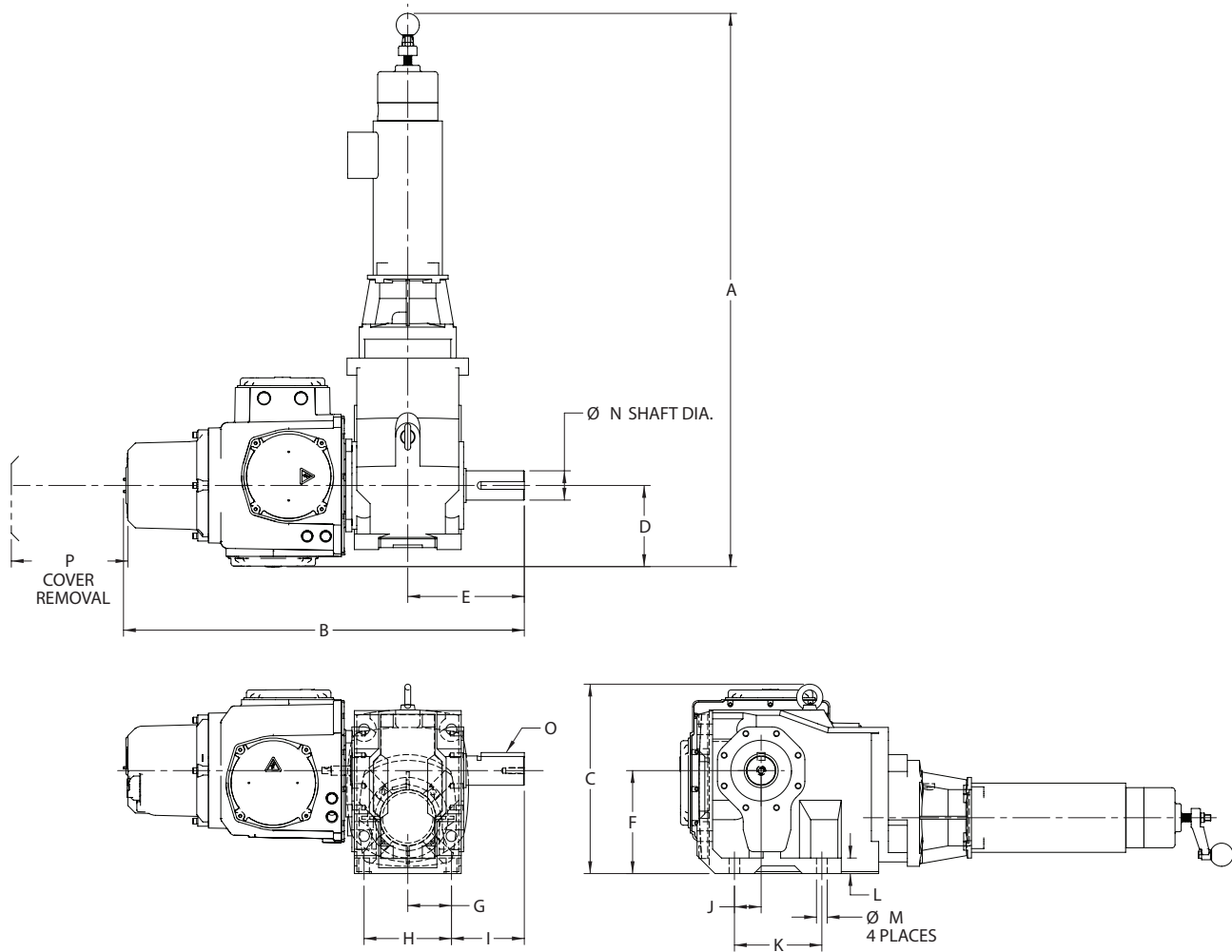

Model	A	B	C	D	E	F	G	H	I	J	K	L	M	N	O	P
10/370	37.60	26.63	12.49	6.58	5.32	5.91	2.36	4.72	2.95	3.50	10.88	1.50	0.56Ø	1.250/1.249Ø	0.25 x 0.25 KEY	8.00
10/800	38.47	28.24	12.59	6.58	6.34	6.01	2.25	4.50	4.09	4.50	13.00	0.50	0.56Ø	1.375/1.374Ø	0.31 x 0.31 KEY	8.00
10/1400	39.24	30.17	14.41	6.58	7.72	7.84	3.25	6.50	4.47	5.38	14.50	0.75	0.81Ø	1.750/1.749Ø	0.38 x 0.38 KEY	8.00
10/2500	43.77	32.49	15.35	6.58	9.45	8.35	3.54	7.09	5.90	2.17	7.09	1.26	0.88Ø	2.375/2.374Ø	0.63 x 0.63 KEY	8.00
10/4400	53.83	35.64	18.78	6.58	11.42	10.43	4.72	9.45	6.69	2.95	9.45	1.50	1.02Ø	2.875/2.874Ø	0.75 x 0.75 KEY	8.00
10/6200	63.67	38.87	22.28	7.87	13.66	12.40	5.31	10.63	8.35	3.74	11.02	1.65	1.30Ø	3.625/3.634Ø	0.88 x 0.88 KEY	8.00
12/8000	71.23	42.84	29.09	8.86	16.45	14.76	6.50	12.99	9.96	4.53	13.78	1.77	1.54Ø	4.375/4.374Ø	1.00 x 1.00 KEY	8.00
12/11000	73.79	45.87	32.40	9.84	17.99	17.72	8.27	16.54	9.72	5.51	14.96	1.97	1.54Ø	4.750/4.749Ø	1.25 x 1.25 KEY	8.00
42/26000	80.48	51.98	36.54	12.40	21.85	19.69	9.45	18.90	12.41	7.87	21.26	1.97	1.30Ø	5.500/5.499Ø	1.25 x 1.25 KEY	8.00

These dimensions are subject to change without notice and should not be used for preparation of drawings or fabrication of installation mounting. For current installation manuals and other product information, see www.rotork.com.

12 - Linkage Options

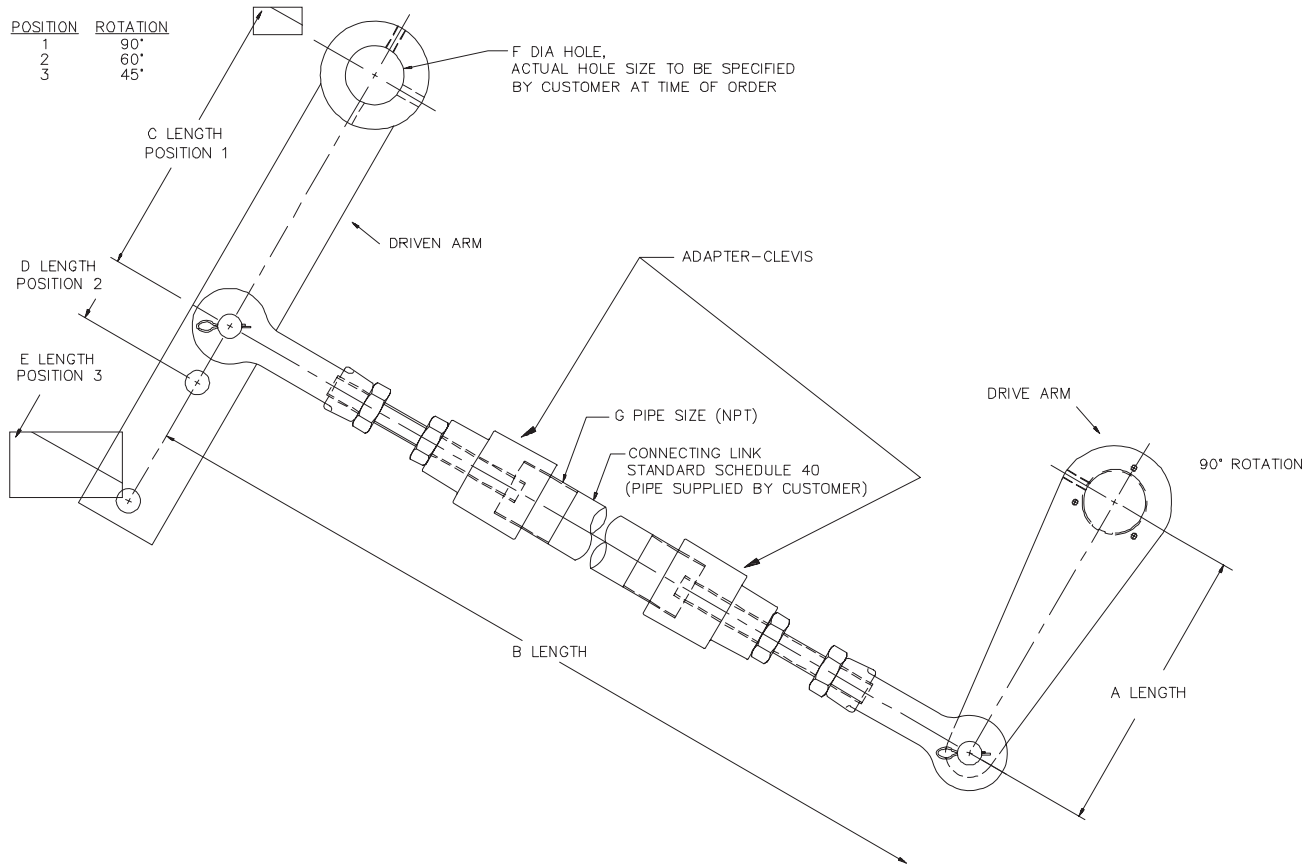

Notes:

1. Maximum total linkage length is specified to prevent buckling under compressive load.
2. Special drive arm lengths are available to meet application requirements.

Model	"A" LENGTH in. (mm) (See Note 3)	"B" MAXIMUM LENGTH ft. (m)	"C" LENGTH in. (mm)	"D" LENGTH in. (mm)	"E" LENGTH in. (mm)	"F" DIA. HOLE min.-max. in. (mm)	"G" PIPE SIZE
370 ft. lb.	10 (254)	18 (5.5)	10 (254)	12.25 (311)	17 (432)	0.75 - 1.5 (19 - 38.1)	1 - 1/4 (NPT)
800 & 1400 ft. lb.	10 (254)	30 (9.1)	10 (254)	12.25 (311)	17 (432)	1 - 2 (25.4 - 50.8)	2 - 1/2 (NPT)
2500 & 4400 ft. lb.	12 (305)	18 (5.5)	12 (305)	14.70 (373)	21.50 (546)	1.5 - 3.5 (38.1 - 88.9)	2 - 1/2 (NPT)
6200 & 16500 ft. lb.	15 (381)	18 (5.5)	15 (381)	18.38 (467)	25.50 (648)	2.5-5 (63.5 - 127)	3 - 1/2 (NPT)

13 - User Settings

Span _____

Zero _____

Max. Cal.: _____

Min. Cal.: _____

Speed: _____

Cmd Type: _____

Cntrl Mech: _____

Comms Settings: _____

LOS Action: _____

P Gain: _____

I Gain: _____

Min Pos _____

Max Pos _____

Max. Torque (%): _____

Max. Torque (ft. lbs.): _____

Input Volts (tp amp from transformer): _____

Motor Rating: _____

Password: _____

Loop: Open _____

Closed _____

CZero 0%: _____

CZero 25%: _____

CZero 50%: _____

CZero 75%: _____

CZero 100%: _____

Additional Information: _____

rotork®

Keeping the World Flowing



www.rotork.com

A full listing of our worldwide sales and service network is available on our website.

UK
Rotork plc
tel +44 (0)1225 733200
fax +44 (0)1225 333467
email mail@rotork.com

USA
Rotork Controls Inc.
tel +1 (585) 247 2304
fax +1 (585) 247 2308
email info@rotork.com

Rotork is a corporate member of the Institute of Asset Management



PUB052-002-00
Issue 02/17

As part of a process of on-going product development, Rotork reserves the right to amend and change specifications without prior notice. Published data may be subject to change. For the very latest version release, visit our website at www.rotork.com

The name Rotork is a registered trademark. Rotork recognises all registered trademarks. The *Bluetooth*® word mark and logos are registered trademarks owned by Bluetooth SIG, Inc. and any use of such marks by Rotork is under license. Published and produced in the UK by Rotork Controls Limited. POWDG0217