

rotork[®]

Keeping the World Flowing
for Future Generations

Skilmatic

SI Range Actuators

Incorporating SI3 and SI4 Electro-Hydraulic
Control Modules

Instructions for Safe Use, Installation,
Basic Setup and Maintenance

⚠ This manual contains important safety information. Please ensure it is thoroughly read and understood before installing, operating or maintaining the equipment.

PUB021-057-00
Date of issue 06/24



UK
CA CE

Table of Contents

1. Introduction _____	3	6. Operating Your SI Actuator _____	14	8. Setting the Indication Switches (Optional) _____	32
1.1 Identifying Actuator Parts	3	6.1 Manual Override (Optional)	14	8.1 Removing the Indication Cover	32
1.2 Rotork Setting Tool	4	6.2 Operating Electrically	16	8.2 Adjusting the Limit Switches	32
1.3 Introduction to this Manual	5	6.3 Accumulator (Optional)	16	8.3 Replacing the Indication Cover	32
2. Health and Safety _____	5	6.4 Display – Local Indication	17	9. Maintenance and Troubleshooting _____	33
2.1 Hazardous Area Approved Actuators	7	6.5 Display – Home Screen Selection	18	9.1 General Maintenance	33
3. Storage _____	7	6.6 Display Status Indication – Travel	19	9.2 Replacing the Filter	34
4. Mounting the Actuator _____	8	6.7 Display Status Indication – Control	19	9.3 Replacing the Hydraulic Fluid	34
4.1 Lifting	8	6.8 Display – Alarm Indication	19	9.4 Approved Fuses	34
4.2 Mounting Orientation	9	7. Basic Settings for Commissioning _____	20	10. Decommissioning and Environmental Considerations _____	35
4.3 Fitting the SI Actuator to a Valve	9	7.1 Connecting to the Actuator	20	11. Weights and Measures _____	36
4.4 Mechanical Adjustment	9	7.2 Security – Password	21	11.1 SI3 Actuators	36
4.5 RH Actuator	10	7.3 Basic Settings Menu	23	11.2 SI4 Actuators	36
4.6 GH Actuator	10	7.4 Limits	24	12. Vibration, Shock and Noise _____	36
4.7 Linear Actuator	10	7.5 Close Settings	25	13. SI Approvals _____	37
5. Cable Connections _____	11	7.6 Open Settings	26	14. Functional Safety _____	39
5.1 Terminal Block Layout	11	7.7 Setting the Actuator Operating Speed (Optional)	26	15. Approved Supply Ratings _____	39
5.2 Earth/Ground Connections	11	7.8 Stroke Tests	27		
5.3 Removing Terminal Cover	12	7.9 Full Stroke Setup	27		
5.4 Cable Entries	12	7.10 Partial Stroke Setup	28		
5.5 Connecting to Terminals	13	7.11 Accumulator Charge Setup	30		
5.6 Replacing the Terminal Cover	13				

1. Introduction

1.1 Identifying Actuator Parts

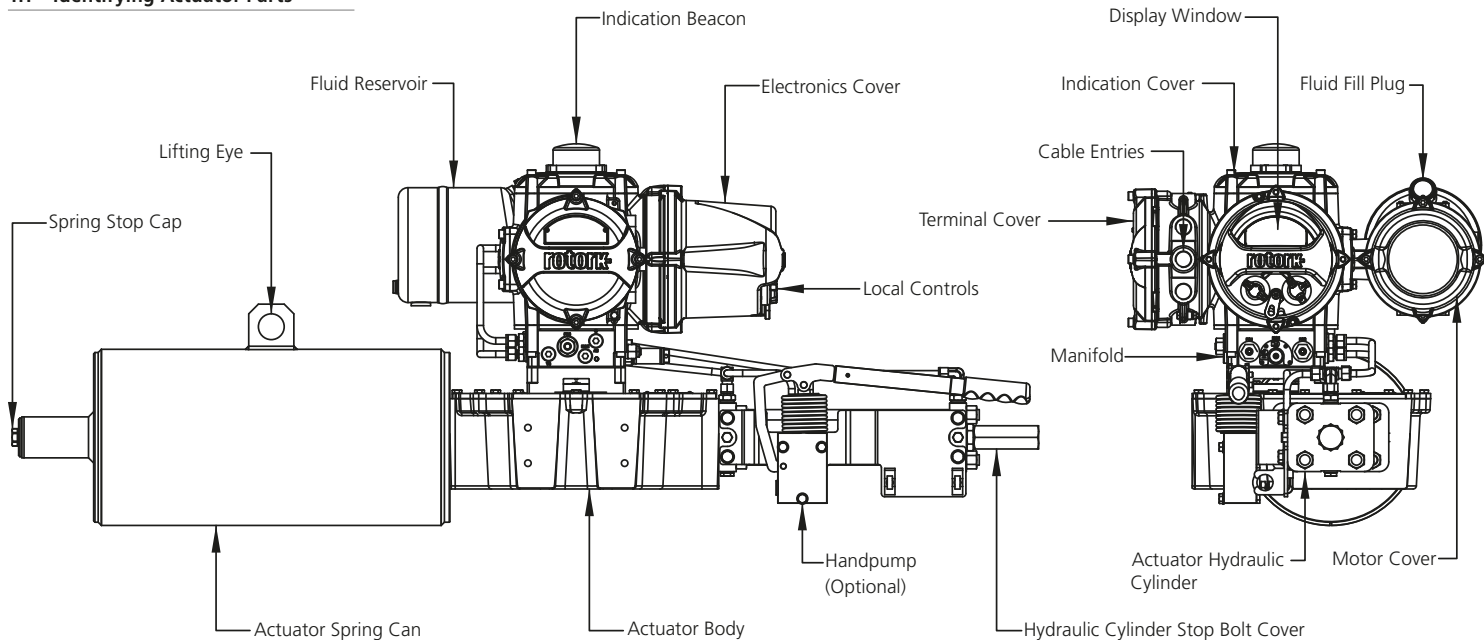

Fig. 1.1.1 S13 actuator

1.2 Rotork Setting Tool

The Rotork Bluetooth® Setting Tool *Pro* v1.1 (BTST) combines the legacy IR and IrDA communication protocols with the latest *Bluetooth*® wireless technology. IR / IrDA support for older Rotork products is retained (for use as an IR communication tool, please refer to publication PUB021-033).

The BTST is able to connect to Rotork Bluetooth wireless enabled actuators and related software to setup and complete missions. Missions are configurable programs of instructions that are to be performed by the BTST on an actuator and include (but are not limited to) downloading configuration and data logger files as well as uploading specific configurations to the actuator. Different missions can be programmed into the BTST via Insight 2.



Rotork Bluetooth® Setting Tool Pro v1.1

Specification

Enclosure: IP54

The BTST has been built in accordance with the following standards:



II 1G
Ex ia IIC T4 Ga
CML 19ATEX2194
IECEX CML 20.0054



CML 21UKEX2122



Ex ia
Class 1, Div 1,
Group A, B, C, D T4
CSA19CA80005457



Ex ia IIC T4 Ga
GB 3836.1-2010,
GB 3836.4-2010
GYJ20.1173X

Ambient Temperature Range:

Tamb = -30 °C to +50 °C

Operating Range:

Infra Red 0.75m

Bluetooth 10m

Enclosure Materials:

Polycarbonate resin containing 10%
Carbon Fibre, Silicone Rubber

Instructions for Safe Selection, Installation, Use, Maintenance and Repair

The following instructions relevant to safe use in a hazardous area covered by the following certificate numbers: CML 19ATEX2194, IECEx CML 20.0054, CML 21UKEX2122 and CSA 80005457.

1. The BTST v1.1 may be used in Division 1, 2 and Zones 0, 1, 2 hazardous areas that require IIC, IIB or IIA protection and temperature class T1, T2, T3 or T4.

2. The following checks must be conducted on the BTST v1.1 prior to taking it into a hazardous area:

a. The BTST v1.1 function must be checked by ensuring a red or green LED illuminates on the front of the setting tool when any button is pressed. If an LED does not illuminate, the BTST v1.1 requires inspection and battery replacement.

b. The BTST v1.1 does not require assembly or dismantling, however suitable precautions must be taken if the BTST v1.1 may come into contact with damaging substances (e.g. solvents that degrade polymeric materials). Regular inspections must be performed to confirm enclosure damage is not apparent. Do not use the equipment if damage is present.

3. The BTST v1.1 is not intended to be repaired by the user. Repair of the equipment is only permitted by the manufacturer or an approved agent in accordance with applicable code of practice.

4. No user adjustment of the BTST v1.1 is required.

5. The BTST must be inspected every three months, in a safe (non-hazardous), dry area by suitably trained personnel, to ensure it has been maintained in accordance with the applicable code of practice.

6. Subject to the applicable code of practice, the batteries may be replaced in a non-hazardous area with one of the following types of Alkaline-Manganese or Zinc-Manganese 'AAA' size batteries:

- Duracell Procell, Type MN2400
- Duracell Ultra
- Duracell Chinese
- Energizer, Type E92
- Energizer, Type E92 Max
- Energizer HighTech
- Panasonic Evolta
- Panasonic Pro Power
- VARTA Industrial
- VARTA High Energy
- Eveready Super

7. The BTST v1.1 contains no other user replaceable parts and it cannot be repaired by the user. If the BTST v1.1 is faulty or needs repairing, it must not be used.

1.3 Introduction to this Manual

This manual provides instruction on:

- Preparation and installation of the actuator onto the valve
- Electrical (local and remote) and optional manual operation
- Basic Commissioning
- Maintenance

Refer to Rotork for repair, overhaul and spare parts.

Refer to Publication PUB021-069 for full configuration, status and monitoring user manual.

Using the supplied Rotork Bluetooth® Setting Tool *Pro* to access the actuator set up procedures, non-intrusive setting of pressure levels, position limits and all other control and indication functions can be made safely, quickly and conveniently, even in hazardous locations. The SI allows commissioning and adjustment to be carried out with the main power supply to the actuator switched on.

Visit our web site at www.rotork.com for more information on the SI, Insight 2 software and other Rotork actuator ranges.

2. Health and Safety

⚠ This symbol identifies important information necessary to avoid a safety hazard, which might cause bodily injury or death.

This manual is produced to enable a competent user to install, operate, adjust and inspect the Rotork SI range of valve actuators. Only persons competent by virtue of their training or experience should install, maintain and repair Rotork actuators.

Under no circumstances should replacement parts be used in Rotork actuators, other than those supplied or specified by Rotork.

Work undertaken must be carried out in accordance with the instructions in this and any other relevant manuals.

If the actuator is used in a manner not specified in this manual and any other Rotork manual, the protection provided by the actuator may be impaired.

The user and those persons working on this equipment should be familiar with their responsibilities under any statutory provisions relating to the Health and Safety of their workplace. Due consideration of additional hazards should be taken when using the SI range of actuators with other equipment.

Should further information and guidance relating to the safe use of the Rotork SI range of actuators be required, it will be provided on request. The electrical installation, maintenance and use of these actuators should be carried out in accordance with the National Legislation and Statutory Provisions relating to the safe use of this equipment, applicable to the site of installation.

For the UK: Electricity at Work Regulations 1989 and the guidance given in the applicable edition of the "IEE Wiring Regulations" should be applied. Also the user should be fully aware of their duties under the Health and Safety Act 1974. For the USA: NFPA70, National Electrical Code® is applicable.

The mechanical installation should be carried out as outlined in this manual and also in accordance with relevant standards such as British Standard Codes of Practice. If the actuator has nameplates indicating that it is suitable for installation in hazardous areas then the actuator may be installed in Zone 1 and Zone 2 classified hazardous area locations only. It should not be installed in hazardous area locations with an ignition temperature less than 135 °C (275 °F), unless suitability for lower ignition temperatures has been indicated on the actuator nameplate.

It should only be installed in hazardous area locations compatible with the gas groups stated on the nameplate.

The electrical installation, maintenance and the use of the actuator should be carried out in accordance with the code of practice relevant for that particular hazardous area certification.

No inspection or repair should be undertaken unless it conforms to the specific hazardous area certification requirements. Under no circumstances should any modification or alteration be carried out on the actuator as this could invalidate the actuators hazardous area approval certification. Access to live electrical conductors is forbidden in the hazardous area unless this is done under a special permit to work, otherwise all power should be isolated and the actuator moved to a non-hazardous area for repair or attention.

⚠ WARNING: Compressed Springs

All springs within the SI range of actuators are pre-compressed. Springs must not be removed from the actuator.

⚠ WARNING: Service Altitude

The actuator installation altitude must be restricted to less than 2000 m as defined by IEC61010-1 (Safety requirements for electrical equipment for measurement, control and laboratory use).

⚠ WARNING: Hydraulic Fluid

SI actuators are filled with hydraulic fluid that could be pressurised to 205 bar (~3000 psi). See actuator data label for the maximum pressure (pressure relief valve setting) and type of fluid specified.

Should there be a requirement to change the fluid, then first ensure that the system is depressurised, and the appropriate protective clothing including gloves and safety glasses are worn. Used hydraulic fluid must be disposed of safely, refer to section 10.

⚠ WARNING: Motor Temperature

Under normal operation the temperature of the actuator's motor cover surfaces can exceed 60 °C above ambient.

⚠ WARNING: External Heat Source

The hydraulic system connected to the control module could provide an external heat source.

⚠ WARNING: Surface Temperature

The installer/user must ensure that the actuator surface temperature rating is not influenced by external heating/cooling effect (e.g. valve/pipeline process temperatures).

⚠ WARNING: Enclosure Materials

Control Module:	Aluminium
Display Window:	Toughened Glass
External Fasteners:	Stainless Steel
Actuator Body:	Carbon Steel
Drive Shaft:	Carbon Steel
Piping:	Stainless Steel
Paint Finish:	Standard 2-Pack epoxy silver grey

The user must ensure that the operating environment and any materials surrounding the actuator cannot lead to a reduction in the safe use of, or the protection afforded by, the actuator. Where appropriate the user must ensure the actuator is suitably protected against its operating environment.

⚠ WARNING: Operating by Hand. With respect to optional manual operation of Rotork SI actuators, refer to section 6.1.

⚠ WARNING: Unit Weight

The actuator weight is shown on the nameplate. Care must be taken to transport, move or lift the actuator safely. Lifting information is available in section 4.

⚠ WARNING: Unexpected Operation

When powered on, actuators can operate unexpectedly. Users must make provision for electrical isolation to prevent unintended operation and associated hazardous events. The actuator's STOP selector (when fitted) is not an isolator and must not be considered as an emergency stop.

2.1 Hazardous Area Approved Actuators

Special Conditions of Safe Use

Refer to the actuator nameplate for unit specific details.

This equipment shall be installed such that the risk of impact to the window is low.

This equipment includes some external non-metallic parts, including the outer protective coating. The user shall therefore ensure that the equipment is not installed in a location where it may be subjected to external conditions (such as high-pressure steam) which might cause a build-up of electrostatic charges on non-conducting surfaces. Additionally, cleaning of the equipment should be done only with a damp cloth.

The equipment utilises A4-80 fasteners, if these are changed they shall only be replaced by A4-80 fasteners.

External cover fasteners must be tightened to 21 Nm (15.5 lbf.ft).

The equipment flamepaths require specialist inspection equipment for verification and should not be repaired. Ensure that appropriately certified threaded adapters, cable glands or conduit are tight and fully waterproof. Seal unused cable entries with steel or brass threaded plugs. In hazardous areas an appropriate certified threaded blanking plug must be installed at the cable entry without the use of an interposing thread adapter.

Actuators approved for use in Ordinary and Hazardous Locations in Canada and the USA require mains supply cables to comply with CSA C22.2 No 21 or ANSI/UL 817.

SI wiring can reach 81 °C (178 °F) in 70 °C (158 °F) ambient temperature.

3. Storage

If your actuator cannot be installed immediately, store it in a dry, well aired place until you are ready to connect incoming cables. Avoid long-term direct exposure to sunlight.

If the actuator has to be installed but cannot be cabled it is recommended that the plastic transit cable entry plugs are replaced with metal plugs.

Apart from the terminal and indication cover, it is not necessary to remove any electrical compartment covers in order to commission the SI actuator.

Fill the reservoir with the correct hydraulic fluid to protect the interior from corrosion.

Visually inspect the equipment periodically to identify any potential corrosion. Repair as required.

Rotork cannot accept responsibility for deterioration caused on-site once the covers are removed.

Every Rotork actuator has been fully tested before leaving the factory to give years of trouble free operation, providing it is correctly commissioned, installed and sealed.

Do not store in temperatures beyond the normal operating range as stated on the data label.

4. Mounting the Actuator

4.1 Lifting

⚠ **NOTE:** Refer to section 11 Weights and Measures for actuator weight.

Ensure the valve is secure before fitting the actuator as the combination may be top heavy and therefore unstable.

If it is necessary to lift the actuator using mechanical lifting equipment then certified slings should be attached as indicated in figure 4.1.1 and figure 4.1.2.

At all times trained and experienced personnel should ensure safe lifting particularly when mounting actuators.

⚠ **WARNING:** The SI actuator must only be lifted as described in figures 4.1.1 and 4.1.2.

⚠ **WARNING:** The actuator should be fully supported until full valve shaft engagement is achieved and the actuator is secured onto the valve flange.

⚠ **WARNING:** Do not lift the actuator and the valve combination via the actuator. Always lift the valve/actuator assembly via the valve flange.

Each assembly must be assessed on an individual basis for lifting.



Fig. 4.1.1. SI3 GH lifting: Slings attached to the lifting eye and hydraulic cylinder stop bolt cover.



Fig. 4.1.2. SI3 RH Lifting: Slings attached to the lifting eye and controller centre housing.

4.2 Mounting Orientation

SI actuators allow many different mounting orientations. The orientation of the motor and fluid reservoir defines the permissible orientations. It is NOT permitted for the fluid reservoir to be installed above the motor, as shown in figure 4.2.1.

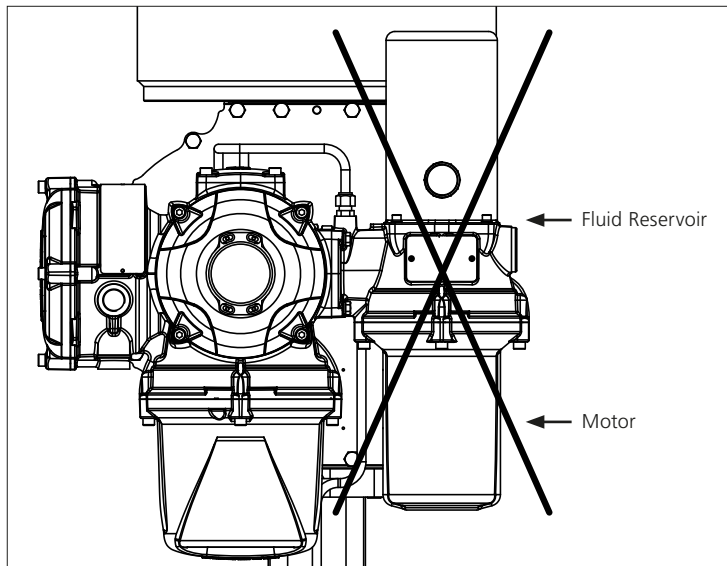

Fig. 4.2.1. The fluid reservoir and motor must **NOT** be mounted in this orientation when vertical.

4.3 Fitting the SI Actuator to a Valve

SI actuators are machined to suit a close coupled ISO 5211 mounting. See section 4.5 and 4.6 for actuator base and mounting information.

If the actuator cannot be mounted directly on to the valve, a separate bracket and coupling will be required.

Before fitting the actuator, ensure that the valve is in the Fail / de-energised position and fit the coupling on the valve, ensuring that the drive is in the correct orientation.

Lower the actuator on to the valve, making sure that the drive is properly located.

Fit the securing bolts, but before tightening ensure that the actuator and valve are properly aligned.

Actuator to valve fixing must conform to material specification ISO Class 8.8, yield strength 628 N/mm².

4.4 Mechanical Adjustment

The mechanical limits of SI actuators are adjusted by using the stop bolts in the end of the hydraulic cylinder and the spring can.

In Fail-closed actuators the stop bolt in the hydraulic cylinder adjusts the closed limit and the spring can adjusts the open limit. In Fail-open actuators it is the opposite way around.

Actuators can be adjusted by $\pm 5^\circ$ in both open and closed position. Giving an overall maximum rotation of 100°.

Adjustment Procedure - Hydraulic Cylinder

- Remove the stop bolt cover and loosen the stop nut.
- Open the actuator slightly to remove the pressure from the stop bolt. The thread in the end plate can be stripped if used to compress the spring.
- Adjust the stop bolt clockwise for reduced rotary motion and anti-clockwise for increased rotary motion of the actuator.
- Once the desired position is achieved, tighten the stop nut, ensuring that the sealing washer is centred on the shaft and seated in the machined recess in the flange.
- Reinstall the stop bolt cover, ensuring that the sealing washer is centred on the shaft and seated in the machined recess in the stop bolt cover.

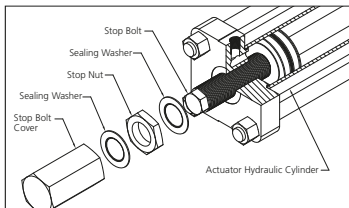

Adjustment Procedure - Spring Canister Adjustment

- Remove the spring stop cap.
- Adjust the stop bolt clockwise for reduced and anti-clockwise for increased rotary motion.
- Once the desired position is achieved, replace the spring stop cap.

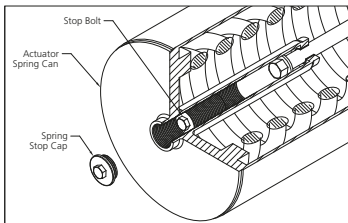

4.5 RH Actuator

For all information regarding the installation and maintenance of these actuators please refer to PUB019-018 RH Installation & Maintenance, available on www.rotork.com.



4.6 GH Actuator

For all information regarding the installation and maintenance of these actuators please refer to PUB011-007 GH Installation & Maintenance, available on www.rotork.com.



4.7 Linear Actuator

For all information regarding the installation and maintenance of these actuators please refer to PUB020-015 LP/S for use with SI Controllers Installation & Maintenance, available on www.rotork.com.



5. Cable Connections

5.1 Terminal Block Layout

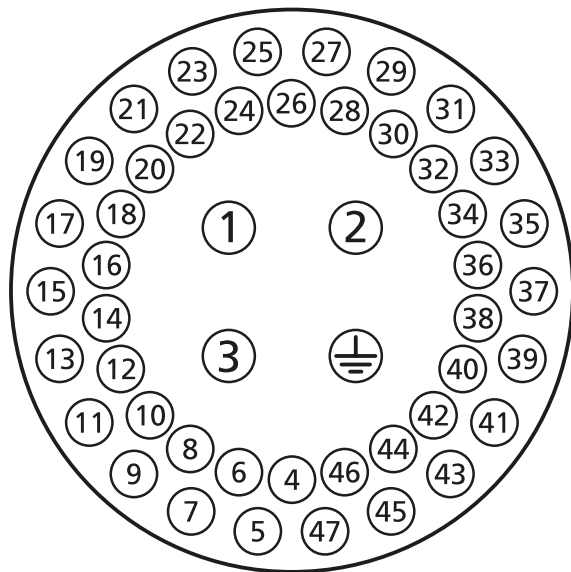

Fig. 5.1.1. Terminal numbers refer to connections as shown on the actuator circuit diagram

⚠ WARNING: Ensure all power supplies are isolated before removing actuator covers.

Check that the supply voltage matches that stamped on the actuator nameplate.

A switch or circuit breaker must be included in the wiring installation of the actuator. The switch or circuit breaker must meet the relevant requirements of IEC60947-1 and IEC60947-3 and be suitable for the application. The switch or circuit breaker must not disconnect the protective earth conductor. The switch or circuit breaker must be mounted as close to the actuator as possible and shall be marked to indicate that it is the disconnect device for that particular actuator. The actuator must be protected with overcurrent protection devices rated in accordance with the electrical data supplied with the actuator.

Power supply cables must have sufficient mechanical protection properties to meet installation requirements and be screened to comply with EMC requirements of the installed actuator. Suitable methods include armoured and/or screened cables or cables contained within conduit.

5.2 Earth/Ground Connections

A lug with a 6 mm diameter hole is cast adjacent to the conduit entries for attachment of an external protective earthing strap by nut and bolt. An internal earth connection is also provided however it must not be used alone as the protective earth connection.

Earth Bonding according to CAN/CSA-C22.2 No. 0.4 shall be considered in the end application where applicable.

⚠ NOTE: After servicing or maintenance, please ensure that the Earth and protective bonding connections are connected in accordance with the wiring diagram. Risk of electric shock if Earth connections are not made.

5.3 Removing Terminal Cover

Using a 6 mm Allen (hex.) key loosen the four captive screws evenly. Do not attempt to lever off the cover with a screw driver as this could damage the O-ring seal and may damage the flamepath on a hazardous area certified unit.



Fig. 5.3.1.

A plastic bag in the terminal compartment contains:

- Terminal screws and washers
- Spare cover O-ring seal
- Wiring diagram
- Instruction manual



Fig. 5.3.2.

5.4 Cable Entries

Only appropriate certified explosion proof cable glands or conduit may be used in hazardous areas.

There are five cable entries in the actuator terminal compartment, which have a M25 x 1.5p thread.

In hazardous areas, only one appropriately certified explosionproof thread adaptor or plug per entry may be used.



Fig. 5.4.1.

Remove plastic transit plugs. Make cable entries appropriate to the cable type and size.

⚠ WARNING: Ensure that threaded adaptors, cable glands or conduit are tight and fully waterproof. Seal unused cable entries with steel or brass threaded plugs. In hazardous areas an appropriate certified threaded blanking plug must be installed at the cable entry without the use of an interposing thread adaptor.

5.5 Connecting to Terminals

Field wiring connections are by wire termination ring crimp terminals. If necessary, suitable insulation must be applied to bare metal ring crimp terminals in order to ensure adequate separation between 'hazardous live' and 'non-hazardous live' circuits considering, and in accordance with, national regulations and statutory provisions.

Check that the supply voltage matches that stamped on the actuator nameplate. See Section 15 for the supply voltage ratings.

⚠ WARNING: To ensure secure electrical connections, it is important that the requisite washers are used as shown in figure 5.5.1. Failure to do so may result in connections working loose or screws not clamping down on ring crimp terminals. Spring washers must be compressed. Screw tightening torques must not exceed 1.5 Nm (1.1 lbf.ft).

⚠ WARNING: For installation in Canada and USA, conduit seals must be installed within 50 mm of the enclosure.

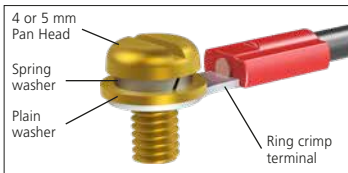

Fig. 5.5.1.

⚠ WARNING: Actuators approved for use in Ordinary and Hazardous Locations in Canada and the USA require mains supply cables to comply with CSA C22.2 No 21 or ANSI/UL 817.

⚠ WARNING: SI Wiring can reach 81 °C (178 °F) in a 70 °C (158 °F) ambient temperature.

⚠ WARNING: Refer to figure 5.1.1 for terminal position numbers. On Ex "e" certified terminal enclosures, connections must be made with AMP ring crimp terminals.

Earth and power, position 1, 2 and 3 must be made with AMP type 160292 - M5 ring crimp terminals.

Control and indication position 4 to 47 must be made with AMP type 34148 - M4 ring crimp terminals.

Refer to the wiring diagram to identify functions of terminals. Check the supply voltage is the same as that marked on the actuator nameplate.

Remove the red power terminal guard.

Begin by connecting power cables and replace guard.

⚠ WARNING: For safety reasons, the same voltage must be connected to actuator terminals that share a common connection. Refer to actuator wiring diagram for information.

All external circuits must be provided with insulation suitable for the rated voltage when considering national regulations and statutory provisions.

⚠ WARNING: For fail-safe on loss of ESD signal only configurations, connection of ESD circuits other than 24 VDC (-15% / +20%) may result in damage to equipment, the risk of fire and high surface temperatures, if there is any doubt about the ESD configuration check the label and wiring diagram or consult the manufacturer.

5.6 Replacing the Terminal Cover

Ensure cover O-ring seal and spigot joint are in good condition and lightly greased before refitting cover.

6. Operating Your SI Actuator

6.1 Manual Override (Optional)

Manual override is not a standard feature on SI actuators. The following section is only applicable for actuators configured for manual override operation.

⚠ WARNING: Manual Operation should only be performed when there is no power supplied to the actuator.



Fig. 6.1.1. Manual Override Handle

⚠ WARNING: The actuator cannot be operated electrically when in Manual Operation mode and will not respond to emergency shut down (ESD) signals until Electrical Operation mode is selected again.

The manual override feature is different for SI actuators without an accumulator and SI actuators with an accumulator. The manual override handle for SI without an accumulator has two positions and turns through 90°. The manual override handle for SI with an accumulator has three positions and turns through 180°. A steel pin fixed to the manual override handle indicates the operating mode. Figure 6.1.1 shows electrical operation is selected.

The following symbols indicate operating mode:

Electrical Operation:



Manual Operation Pump to Open:



Manual Operation Pump to Close:



Stop:



The default position (normally closed or normally open) is determined by the actuator configuration.

Fail Safe Without Accumulator

- Pull the manual override handle outwards and turn to select Manual Operation.
- Pull the hand pump handle out of the storage clips.
- Slide the hand pump handle onto the hand pump lever and fit the retainer pin to hold them together.
- In a smooth action, move the hand pump handle up and down to pump fluid into the hydraulic cylinder.
- To return the actuator to the fail safe position, pull the manual override handle outwards and rotate it to select Electrical Operation. Pressure will release from the cylinder and the actuator will move.

Stayput Without Accumulator

- Leave the manual override handle in the Electrical Operation position.
- Pull the pump handle out of the storage clips.
- Slide the handle onto the hand pump lever and fit the retainer pin to hold them together.
- In a smooth action, move the hand pump handle up and down to pump fluid into the hydraulic cylinder.
- To return the actuator to the default position, pull the manual override handle outwards and rotate it to select Manual Operation.

Fail Safe With Accumulator

Manually operate the actuator using stored energy from the accumulator.

- Pull the manual override handle outwards and rotate to select Manual Operation.
- To stop the actuator, pull the manual override handle outwards and rotate to select Stop.
- To return the actuator to the fail safe position, pull the manual override handle outwards and rotate it to select Electrical Operation. Pressure will release from the cylinder and the actuator will move.

A hand pump can be used to manually operate the actuator if accumulator pressure is depleted. Accumulator pressure can only be replenished electrically. Ensure any accumulators are isolated before hand pump operation, refer to hydraulic schematic.

Stayput With Accumulator

Manually operate the actuator using stored energy from the accumulator.

- Pull the manual override handle outwards and rotate to select Manual Operation.
- To stop the actuator, pull the manual override handle outwards and rotate to select Electrical Operation.

A hand pump can be used to manually operate the actuator if accumulator pressure is depleted. Accumulator pressure can only be replenished electrically.

Preventing Unauthorised Use

Unauthorised use can be prevented by installing a padlock with a 5 mm shackle through the manual override handle. Operating mode will remain fixed to the selected mode.



Fig. 6.1.2. Padlocked handle

⚠ Note: When using the manual override in a Safety Instrumented System (SIS), please refer to the SI safety manual. This is available upon request from Rotork.

6.2 Operating Electrically

Check that the power supply voltage matches with that on the actuator nameplate. Switch on the power supply.

⚠ WARNING: Do not operate the actuator electrically without first checking, using a Setting Tool, that at least the Basic Settings have been made (refer to section 7).

Selecting Local/Stop/Remote Operation

The red selector enables either Local or Remote control, lockable in each position using a padlock with a 6.5 mm shackle.

When the selector is locked in the Local or Remote positions the Stop facility is still available. The selector can also be locked in the Stop position to prevent electrical operation by Local or Remote control.



Fig. 6.2.1. SI Local Controls

Local Control

Position the red selector to Local as shown in figure 6.2.1, turn the adjacent black selector to select the Open or Close commands. Select Stop by turning the red selector 90° clockwise.

Remote Control

Position the red selector to Remote, this allows the remote control signals to operate the actuator. Select Stop by turning the red selector 90° anti-clockwise.

6.3 Accumulator (Optional)

The accumulator for spring-return actuators is used to speed up operation against the spring. Accumulators are an energy storage method using pressurised hydraulic fluid. The fluid is pressurised using a high pressure inert gas (normally nitrogen). SI actuators automatically maintain fluid pressure in the accumulator during normal operation.

Pre-charging the accumulator and the safe use of pre-charging equipment must be performed in accordance with the manufacturer's instructions.

SI actuators can also be operated in the hydraulic and spring direction while powered off if there is enough stored energy available in the accumulator.

⚠ WARNING: Stored energy in accumulators has the potential to cause harm. Always assume the accumulator is pressurised until the accumulator pressure can be verified as low.

⚠ WARNING: Powered off equipment may unexpectedly move.

⚠ WARNING: Hydraulic accumulators are pressure vessels therefore installation, commissioning, disassembly and maintenance should only be performed by professionally trained, qualified personnel.

⚠ WARNING: Nitrogen (used to pre charge the accumulator) is an Oxygen depleting gas. Ensure any decharging of accumulators is done in a well ventilated area.

6.4 Display – Local Indication

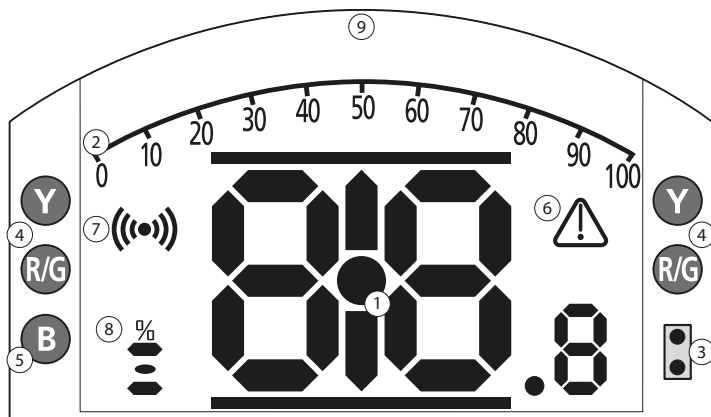

LED INDICATION: R = RED, G = GREEN, Y = YELLOW, B = BLUE

Fig. 6.4.1. Segment Display

1. Position Display

This is the main segment display for position and pressure; position indication to one decimal place.

2. Analogue Scale

When analogue pressure (% of rated) or positioning (% position / demand) homescreens are selected. Refer to section 6.4.

3. Infrared LEDs

Used for older models of setting tool and to initiate a data connection using Bluetooth wireless technology.

4. Dual Position LEDs

Consisting of 2x Yellow for mid-position and 2x bi-colour (Red / Green) for end of travel indication.

5. Bluetooth Indication LED

A dual intensity LED for indicating an active connection using Bluetooth wireless technology.

6. Alarm Icon

This will be displayed for valve, control and actuator alarms. Alarm indication is supported by a status description in the text in the line above the main display.

7. Infrared Icon

This icon flashes during setting tool communication activity. LEDs will also flash when keys are pressed.

8. Percentage Open Icon

When a number value is shown to indicate the valve position e.g. 57.3. This icon will be displayed.

9. Display

A high resolution 168x132 pixel display for displaying setup menus and data log graphs.

When a positional display is active, the status and active alarms will be displayed.

The LCD screen is made up of two layers; the main segment display and the dot matrix display. The displays are dual stacked so that either display can be enabled to show different information. This also allows a combination of both displays for added flexibility.

The LCD is backlit with a white light to enable the best viewing contrast in all lighting conditions. For additional positional indication, the LEDs at either side of the LCD are used for Closed (red), mid-travel (yellow) and Open (green) as standard. These LEDs are fully configurable in the settings menu or on request at time of order.

6.5 Display – Home Screen Selection



The actuator display can be set to show any one of the following home screens:

- Digital position indication
- Digital pressure & digital position indication
- Position & control demand indication

The default home screen is Digital Position indication. Home screens indicate the live conditions measured by the actuator.

The required home screen can be set by the user either as a permanent display or as a temporary display for valve or actuator operational analysis.

Temporary Home Screen display.

Using the setting tool (refer to section 7.1)  or  arrow keys, scroll through the available home screens until the required one is displayed. The selected screen will remain displayed for approximately 5 minutes after the last setting tool command or until the actuator power is cycled.

Permanent Home Screen display.

Using the setting tool (refer to section 7.1) connect to the actuator.

From the **Settings** menu, select **Indication, Local Display**. From the available settings, select Home Screen. Enter the password if requested (refer to section 7.2), select **Home screen** and from the dropdown list, select the required Home screen for permanent display:

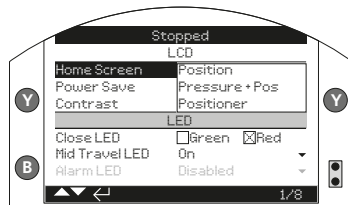

Fig. 6.5.1. Home Screen Selection

Position - Digital Position Indication (Default)

Pressure + Pos - Digital pressure & digital position indication

Positioner - Position & control demand indication

Once selected, the set display will be the active, permanent home screen. Refer to Figs 6.5.2 to 6.5.5.

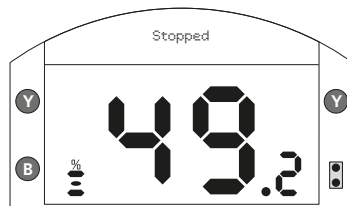

Fig. 6.5.2. Position

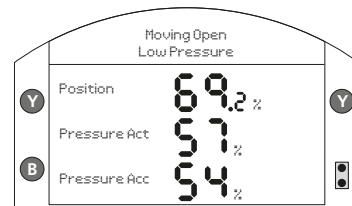

Fig. 6.5.4. SI4 Pressure + Pos

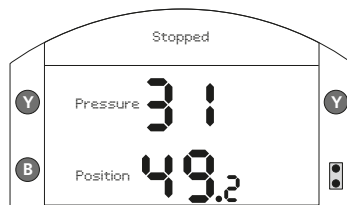

Fig. 6.5.3. Pressure + Pos

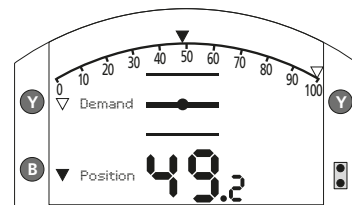

Fig. 6.5.5. Positioner

6.6 Display Status Indication – Travel

The SI display provides real-time status indication. The top line of the text area is reserved for travel status indication.

Figure 6.6.1 shows the travel status example of **Close Limit**.

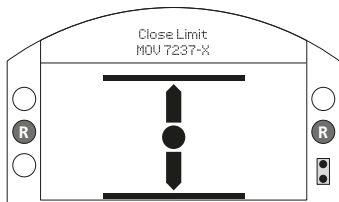

Fig. 6.6.1.

6.7 Display Status Indication – Control

The bottom line of the text area is reserved for control status indication and is displayed for approximately 2 seconds after the control mode or signal is applied.

Figure 6.7.1 shows the control status example **Remote Control**.

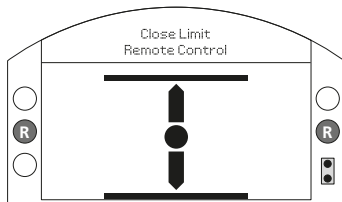

Fig. 6.7.1 .

6.8 Display – Alarm Indication

The SI display provides indication of an alarm or a fault in the form of text and an icon.

The alarm icon will be displayed on the right hand side of the screen. This will be supported with text in the bottom line indicating the particular alarm. If more than one is present, each will be displayed in sequence.

Figure 6.8.1 shows the status example **ESD Active**.

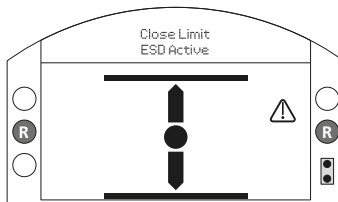

Fig. 6.8.1.

7. Basic Settings for Commissioning

All actuator settings, data logger and asset management data is accessed using the supplied Rotork Bluetooth® Setting Tool Pro (BTST). Status and alarm data in addition to that shown on the home screen can also be accessed.

⚠ WARNING: The electronics cover must not be removed; no user configurable settings are available within the electronics enclosure. The electronics cover is sealed by a quality label which if broken may invalidate warranty.

This instruction details the basic settings that must be completed before the actuator is put into service.

⚠ WARNING: Electrical operation must not take place until the basic settings have been made and checked.

The basic settings affect the correct operation of the valve by the actuator. If the actuator has been supplied with the valve, the valvemaker or supplier may have already made these settings.

⚠ WARNING: Settings and Operation must be verified by electric operation and a functional test of the actuated valve.

THIS PUBLICATION PROVIDES INSTRUCTION ON MAKING THE BASIC SETTINGS ONLY.

For instruction on control and indication settings and for information on diagnostics refer to PUB021-069.

7.1 Connecting to the Actuator

The Rotork setting tool incorporating Bluetooth wireless technology (Rotork Bluetooth® Setting Tool Pro v1.1 - BTST) is shown below. It is identified by the key symbols being clear and a clear seal between the top and bottom casings.

The infrared only tool has filled yellow keys and a yellow seal between the top and bottom casings.



Below are the relevant navigation and configuration keys to commission an SI range actuator.

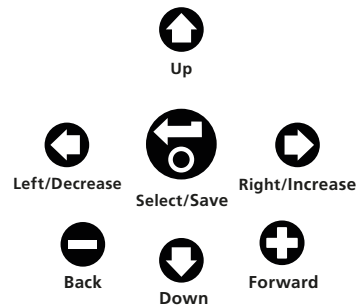

Connecting to the Actuator using Bluetooth

The default setting for Bluetooth connection is by initiation using an infrared command. This means that the user must be in close proximity and in direct line of sight of the actuator.

Point the setting tool at the actuator display window within a range of 0.25 m (10 in) and Press  key.

The screen will change to the Main Menu screen, see figure 7.1.1.

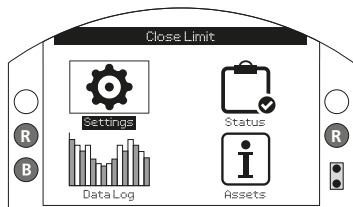



Fig. 7.1.1.

The BTST will automatically connect using Bluetooth which takes up to 5 seconds and when connected will be indicated by blue lights illuminating on the tool and in the actuator display window. Once connected, the tool can be used without pointing it at the actuator display window.

Bluetooth connection will be maintained while setting tool key commands are made. After a period of 6 minutes with no key commands, Bluetooth connection will be turned off and the BTST and display blue lights will go out. To manually turn off Bluetooth connection at any time, press the setting tool  and  keys together.

7.2 Security – Password

The default security level for connecting to the actuator is by infrared Bluetooth initiation. This requires that the user is at the actuator within 0.25 m distance and in direct line of sight of the display. For instruction on connecting to the actuator refer to section 7.1.

All actuator settings can be viewed with the actuator in Local, Stop or Remote mode.

To change an actuator setting, the actuator must be in Local or Stop mode and a correct password entered.

If the actuator is in Remote mode and a setting is selected, the following warning will be displayed:

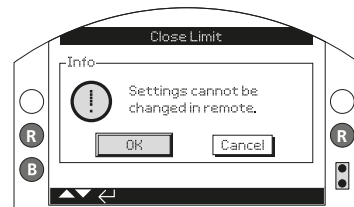

Fig. 7.2.1.

Select OK and press the  key to return to the settings screen.

With the actuator in Local or Stop mode and when any function is selected, the Password screen will be displayed:

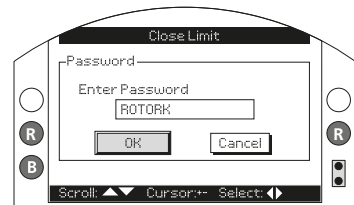

Fig. 7.2.2.

ROTORK is displayed and the OK key is highlighted. ROTACT permits read only access to settings.

Input the default user password ROTACT using the instructions below. ROTACT permits read and write access to settings.

Use to highlight password entry box and press .

Use to scroll through alphanumeric values to display required character.

Use to move to the next character.

Use to delete the highlighted character.

Use when selected password is complete.

Navigate to the OK button using . Press .

The **settings** screen will again be displayed. The example below shows **Settings – Limits – Close Settings** with the function **Action** highlighted:

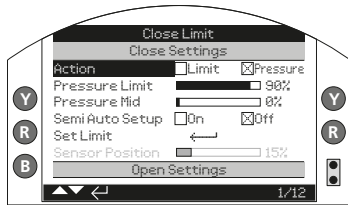

Fig. 7.2.3.

Press the key to select.

The function and its setting **option** or range will then be highlighted:

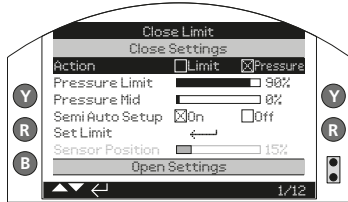

Fig. 7.2.4.

If the user does not wish to change the function value, press the key to escape without changing.

Use the or arrow keys to change the setting to the required value, the example below shows a close action of Limit selected.

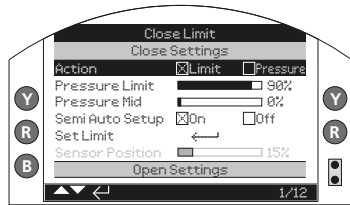

Fig. 7.2.5.

Press the key to save.

The highlight will return to the function name only and its stored setting will be displayed:

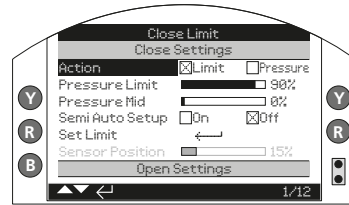
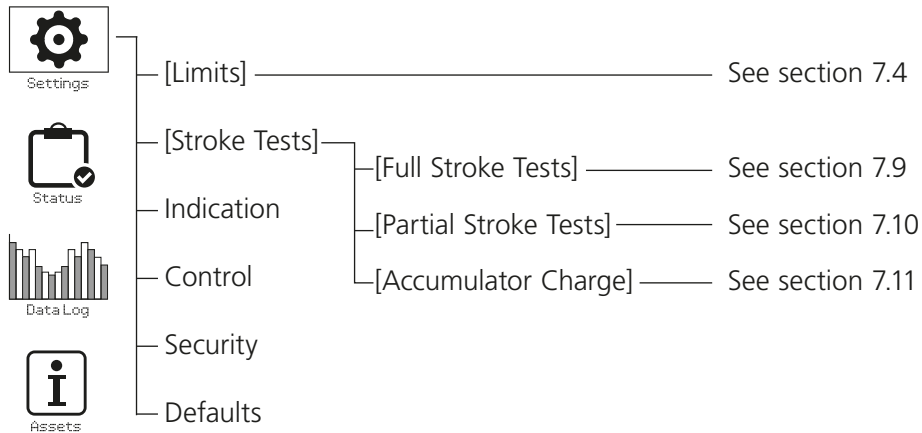

Fig. 7.2.6.

The password will be requested the first time a function is selected. Once correctly entered, the password will not be required to be entered again for the duration of setting tool communication with the actuator. Other functions can be set as required.

7.3 Basic Settings Menu



7.4 Limits

⚠ Settings and operation must be verified by electric operation and a functional test of the actuated valve.

Connect to the actuator as described in section 7.1. From the Position display home screen press the  key. The main menu will be displayed.

Navigate to Settings using the    keys and press  to select.

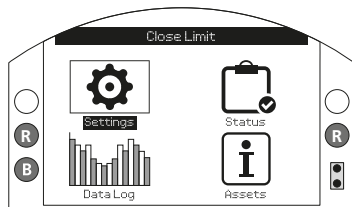



Fig. 7.4.1.

The settings menu will be displayed:

Settings
Limits
Stroke Tests
Indication
Control
Security
Defaults

Navigate to Limits using the   keys and press  to select.

The setting first selected to be changed will require a password to be entered, refer to section 7.2.

The limit settings are shown below with their factory default values:

Stopped			
Close Settings			
1 / 12	Action	<input type="checkbox"/> Limit	<input checked="" type="checkbox"/> Pressure
2 / 12	Pressure Limit		90%
3 / 12	Pressure Mid		0%
4 / 12	Semi Auto Setup	<input checked="" type="checkbox"/> On	<input type="checkbox"/> Off
5 / 12	Set Limit		
6 / 12	Sensor Position		49%
Open Settings			
7 / 12	Action	<input checked="" type="checkbox"/> Limit	<input type="checkbox"/> Pressure
8 / 12	Pressure Limit		90%
9 / 12	Pressure Mid		0%
10 / 12	Semi Auto Setup	<input checked="" type="checkbox"/> On	<input type="checkbox"/> Off
11 / 12	Set Limit		
12 / 12	Sensor Position		49%
			1 / 12

Function Action (1/12) is shown highlighted. Use   to scroll through functions. Functions will be highlighted in turn.

Each actuator is built in the factory to be either Normally Closed, Normally Open or Stayput depending on what configuration was ordered.

Consult the factory if this configuration needs to be changed as it cannot be done through software alone.





7.5 Close Settings

The close settings are displayed on lines 1/12 to 6/12.

1/12. Action



The actuator can be configured to close on pressure (hydraulic or spring) for seating valves or Limit for non-seating valves.

The actuator will stop at the mechanical end stop if set to Pressure and the electrical limit if set to Limit.

Press  to select Close Action function. Use  or  to check function setting. Press  to set.

2/12. Pressure Limit

This setting is the maximum cut-off pressure in a normally open actuator while traveling from the closed electrical limit to the closed mechanical end stop. The value set is a % of the maximum system pressure, which is limited by the pressure relief valve.

Press  to select the Pressure Limit function. Use  key to decrease value and  key to increase value.

Press  key to set.

3/12. Pressure Mid

This setting is the maximum cut-off pressure in a normally open actuator while traveling in mid-travel between the open and closed electrical limits while closing. This can be set between 0% and 100%. When set at 0% the Pressure Mid value is set at the same as the Pressure Limit. When set between 1% to 100%, the Pressure Mid value is a proportion of the maximum system pressure.

⚠ WARNING: If the actuator fails to complete a close or open operation due to the set pressure being reached, it may indicate a valve and/or process problem or change. It is the responsibility of the user to ensure the valve and process conditions are within the specified operational limits.

4/12. Semi Auto Setup

When this setting is on, it allows the closed electrical limit to be set by moving the actuator to the closed mechanical end stop and storing its position. The electrical limit will then be scaled in 1% between the closed and open end stops.

When this setting is off, it allows the closed electrical limit to be manually set by moving the actuator to the desired position and then storing it. The electrical limit needs to be set in from the mechanical end stop by at least 1%.

5/12. Set Limit

Press  to set the closed limit.

If Semi Auto Setup is turned on the following instruction will be shown:

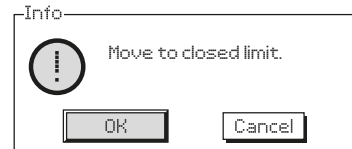

Move the actuator to the closed mechanical end stop using the local controls and select OK.

If Semi Auto Setup is turned off the following instruction will be shown:

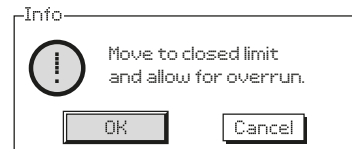

Move the actuator to the closed position where the electrical limit needs to be set using the local controls and select OK.

6/12. Sensor Position

This is a live reading of the position sensor which can be viewed when setting the limits. This setting is non-adjustable.

7.6 Open Settings

The open settings are displayed on line 7/12 to 12/12. They are configured in exactly the same way as the close settings.

7.7 Setting the Actuator Operating Speed (Optional)

The actuator limits must be set prior to any speed adjustment being made, speed is pre-set in the factory but operating conditions may require the speed to be adjusted once installed on site.

Operating speed in both directions, opening and closing, can be optionally regulated depending on configuration. The operating speed is measured in seconds, and is the elapsed time from commencement of actuator movement to the completion of the movement. Depending on the configuration of actuator, the speed can be controlled in one direction, both directions or not at all – the actuator will move as quickly as possible.

Where the movement is powered by the stored energy in the spring, the operating time is known as the spring-speed. Control can also be optionally configured in the movement direction powered by the hydraulic pump/accumulator, this is the hydraulic speed.

Spring Direction Operating Speed

SI actuators can include optional mechanical speed control in the spring direction. Speed adjustment is possible using a combination of hardware configurations including fixed and adjustable valves.

- FC1 – A plug, flow control valve or pressure compensating valve.

Flow control valve - Adjust clockwise to slow down and anti-clockwise to speed up.



Pressure compensating valve - Adjust anti-clockwise to slow down and clockwise to speed up.



- FC3 – A fixed orifice restrictor or fixed pressure compensating valve to maintain a minimum operating speed.

Hydraulic Direction Operating Speed

Operating speed in the hydraulic direction is controlled using a stepping function configured in the actuator settings. Refer to PUB021-069 SI Full Configuration Manual.



SI actuators with an accumulator also include a mechanical speed control option using a standard flow control valve fitted to port FC4 (clockwise to slow down and anti-clockwise to speed up).

7.8 Stroke Tests

Part of the basic setup of the actuator is to run the stroke test setups.

Navigate to the settings menu as described in section 7.3.

Settings
Limits
Stroke Tests
Indication
Control
Security
Defaults

Using the   keys once in the settings menu, go to Stroke Tests and press  to select.





The stroke tests menu gives 3 options.

Stroke Tests
Full Stroke Tests
Partial Stroke Tests
Accumulator Charge

7.9 Full Stroke Setup

The full stroke setup must be carried out during the commissioning of the actuator and when any subsequent process changes are made. The operating times recorded during the setup are then used to determine the result of all full stroke, partial stroke and accumulator charge tests carried out.

The Full Stroke settings are shown below with an example of the full stroke times recorded.

Open Limit	
Full Stroke	
1 / 13	Setup 
2 / 13	Test 
3 / 13	Result (Last test) Pass
Full Stroke Times (Secs)	
4 / 13	Open (Setup) 37.67
5 / 13	Open (Min) 30.13
6 / 13	Open (Max) 45.20
7 / 13	Open (Last Test) 37.60
8 / 13	ESD (Setup) 0.93
9 / 13	ESD (Min) 0.75
10 / 13	ESD (Max) 1.12
11 / 13	ESD (Last Test) 0.93
12 / 13	Close (Setup) 10.10
13 / 13	Close (Last Test) 10.08
   1 / 10	

1/13. Setup

This setting will perform the initial 'commissioning' full stroke setup, which will be used as a benchmark for any full stroke tests conducted after this is completed. The actuator may perform a number of full strokes at different operating speeds depending on the configuration of the actuator. The actuator must be at either the closed or open limit and set to local.

Press  to select the setup function. The actuator will display the following instruction:

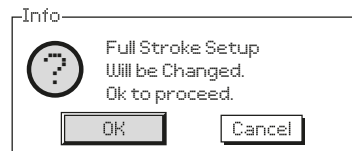

2/13. Test

This will perform a full stroke test. The actuator will record the time taken to move between its limits.

The actuator will display the following instruction when this is used:

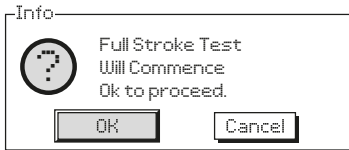

3/13. Result (Last Test)

The result from the last test can be seen in the right hand column. The results are compared with the setup stroke. If this time is more than a pre-set tolerance (see below), then the test will be classed as a fail with a reason why.

4/13 – 10/13. Full Stroke Times

This section displays the times recorded for the full stroke setup and subsequent tests. The data is displayed in seconds.

4/13. Open (Setup) – this is the actual time recorded when an open command is simulated during the full stroke setup (fixed).

5/13. Open (Min) – this time can be adjusted and is used to determine a pass or fail. By default it is set to be the Open (Setup) time less 10%.

6/13. Open (Max) – this time can be adjusted and is used to determine a pass or fail. By default it is set to be the Open (Setup) time plus 10%.

7/13. Open (Last Test) – this is the actual time recorded when an open command is simulated during the full stroke test (fixed).

8/13. ESD (Setup) – this is the actual time recorded when an ESD command is simulated during the full stroke setup (fixed).

9/13. ESD (Min) – this time can be adjusted and is used to determine a pass or fail. By default it is set to be the ESD (Setup) time less 10%.

10/13. ESD (Max) – this time can be adjusted and is used to determine a pass or fail. By default it is set to be the ESD (Setup) time plus 10%.

11/13. ESD (Last Test) – this is the actual time recorded when an ESD command is simulated during the full stroke test (fixed).

12/13. Close (Setup) – this is the actual time recorded when a close command is simulated during the full stroke setup (fixed).

13/13. Close (Last Test) – this is the actual time recorded when a close command is simulated during the full stroke test (fixed).

7.10 Partial Stroke Setup

The partial stroking function of the SI software allows the user to check if the actuator or valve is likely to fail due to mechanical wear or damage without fully stroking the valve and disrupting the process medium.

A Partial Stroke Test can be performed via the local display menus. 'Charging prior to PST!' will appear if a pressure top up is necessary before the test starts.

The Partial Stroke settings are shown below with an example of the partial stroke times recorded.

Open Limit	
Partial Stroke	
1 / 8	To Position <input type="text" value="90%"/>
2 / 8	Setup
3 / 8	Test
4 / 8	Result (Last test) Pass
Partial Stroke times (Secs)	
5 / 8	ESD (Setup) 1.27
6 / 8	ESD (Last test) 1.27
7 / 8	Open (Setup) 6.32
8 / 8	Open (Last Test) 6.31
1 / 8	

1/8. To Position

This will determine which position the actuator performs the partial stroke to. It can be set from 1%-99%. The default setting is 90%, assuming that the actuator is normally closed then it will move from the open limit, to 90% open and then back to the open limit.

2/8. Setup

This setting will perform the initial 'commissioning' partial stroke setup, which will be used as a benchmark for any partial stroke tests conducted after this is completed. The actuator may perform a number of partial strokes at different operating speeds depending on the configuration of the actuator. The actuator must be at the correct limit (open limit for a normally closed actuator) and set to local.

Press  to select the setup function. The actuator will display the following instruction:

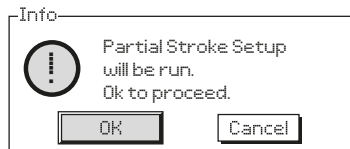

3/8. Test

This will perform a partial stroke test. The actuator will record the time taken to move to the position set in 1/8 and then back again.

The actuator will display the following instruction when this is used:

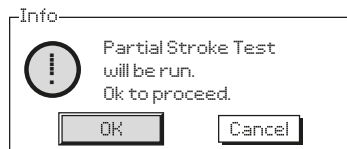

4/8. Results (Last Test)

The result from the previous test can be seen in the right hand column. The results are compared with the setup stroke. If this time is more than a pre-set tolerance then the test will be classed as a fail. The tolerance is calculated by taking the ratio of the full stroke and partial stroke setup times and scaling the min/max times set for the full stroke test.

5/8 – 8/8. Partial Stroke Times

This section displays the times recorded for the partial stroke setup and subsequent tests. The data is displayed in seconds.

5/8. ESD (Setup) – this is the actual time recorded when an ESD command is simulated during the partial stroke setup (fixed).

6/8. ESD (Last Test) – this is the actual time recorded when an ESD command is simulated during the partial stroke test (fixed).

7/8. Open (Setup) – this is the actual time recorded when an open command is simulated during the partial stroke setup (fixed).

8/8. Open (Last Test) – this is the actual time recorded when an open command is simulated during the partial stroke test (fixed).

7.11 Accumulator Charge Setup

The Accumulator Charge test allows the user to check correct function of the accumulator by analysing the pressure against time response.

The Accumulator Charge test settings are shown below with an example of the charge times and pressures recorded.

Stopped	
Accumulator Charge	
1 / 8	Setup ←←
2 / 8	Test ←←
3 / 8	Result (Last test) Pass
Accumulator Charge Times	
4 / 8	Setup 95.17
5 / 8	Test 92.95
Accumulator Pre Charge	
6 / 8	Factory 60
7 / 8	Setup 60
8 / 8	Test 60

The Accumulator Set Pressure is a unit specific factory configuration, determined by application.

1/8. Setup – record a healthy Accumulator Charge cycle. Setup should only be performed during initial actuator commissioning. Setup will charge the Accumulator to the Set Pressure and record the Setup Charge Time (4/8). Setup Pre-Charge (7/8) pressure is calculated. Setup is used as a healthy benchmark when performing an Accumulator Charge Test (2/8).

Press  to select the Setup function and follow the on-screen instructions.



Move the local controls to the STOP position and select OK with the setting tool. If the controls are not in STOP, the warning will not change.

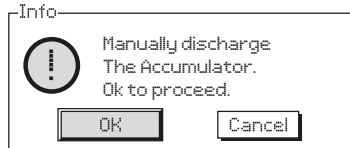

Fully discharge the Accumulator, refer to the Hydraulic Circuit schematic. When Accumulator pressure equals 0, select OK with the setting tool. If pressure is not 0, the warning will not change.

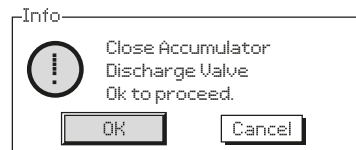

Manually close the Accumulator Discharge Valve, refer to the Hydraulic Circuit schematic. Select OK to continue.

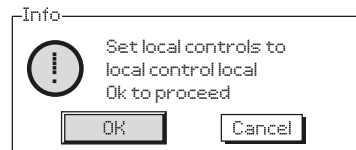

Move the actuator local controls to LOCAL then select OK to continue. The Accumulator will begin charging. If the controls are not in LOCAL, the warning will not change and the Accumulator will not charge.

Selecting Cancel at any point or setting the actuator local controls to STOP during the charge process will abort the setup.

2/8. Test – perform an Accumulator Charge Test. The actuator will repeat the charge cycle detailed in Accumulator Charge Setup (1/8). Follow the on-screen instructions to complete the Accumulator Charge Test. Test Charge Time (5/8) is recorded and Test Pre-Charge (8/8) pressure is calculated.

3/8. Result (Last Test) – will indicate if the last Accumulator Charge Test (2/8) performed was a Pass or Fail. The recorded Test Charge Time (5/8) must be within $\pm 10\%$ of the Setup Charge Time (4/8) to achieve a Pass.

4/8. Setup – displays the time (in seconds) to perform the Setup Accumulator Charge (1/8) cycle.

5/8. Test – displays the time (in seconds) to perform the Test Accumulator Charge (2/8) cycle.

6/8. Factory – displays the configured Factory Pre-Charge pressure. Values shown are a percentage of the maximum system pressure.

7/8. Setup – displays the calculated Setup Pre-Charge pressure. Values shown are a percentage of the maximum system pressure.

8/8. Test – displays the calculated Test Pre-Charge pressure. Values shown are a percentage of the maximum system pressure.

8. Setting the Indication Switches (Optional)

The SI can be fitted with up to four internal indication switches which can be used to monitor the position of the actuator. These are accessed by removing the indication cover.

⚠ WARNING: Ensure all power supplies are isolated before removing the indication cover.

8.1 Removing the Indication Cover

Using a 6 mm Allen (hex.) key, loosen the four captive screws evenly. Do not attempt to lever off the cover with a screw driver as this could damage the O-ring seal and may damage the flamepath on a certified unit.

8.2 Adjusting the Limit Switches

The limit switches are stacked next to the indication shaft. Attached to the shaft are the limit switch cams. The switches can be triggered at different points through the actuator movement by adjusting the offset angle on the cams. The cams are adjusted by moving them away from their seat and then rotating them into the desired position. Once released the spring will push the cam back into its seat.



Fig. 8.2.1.



Fig. 8.2.2.

8.3 Replacing the Indication Cover

Ensure the cover O-ring seal and spigot joint are in good condition and lightly greased before refitting cover. Check that the shaft coupling groove on the underside of the cover is aligned with the indication shaft slot. Carefully place the cover back on as straight as possible and press down until it is fully engaged. Tighten all four screws evenly.

9. Maintenance and Troubleshooting

9.1 General Maintenance

Every Rotork actuator has been fully tested before dispatch to give years of trouble-free operation providing it is installed, sealed and commissioned in accordance with the instructions given in this publication.

The SI actuator's non-intrusive enclosure provides complete protection for the actuator components. Covers should not be removed for routine inspection as this may be detrimental to the future reliability of the actuator. The enclosure contains no user serviceable components.

All electrical power supplies to the actuator must be isolated before any maintenance or inspection is carried out.

Electrical supplies must be isolated before actuator covers are removed

If the motorised valve is rarely operated, a routine operating schedule should be set up, which may include partial stroking the actuator at regular intervals.

Routine maintenance should include the following:

- Check actuator valve fixing bolts for tightness.
- Ensure valve stems and drive nuts are clean and properly lubricated.
- Check the control module enclosure for external damage, loose or missing fasteners.
- All external fasteners must be tightened to 21 Nm (15.5 lbf.ft).
- Ensure there is not an excessive build-up of dust or contaminant on the actuator.
- Check for any loss of hydraulic fluid. This can be done by removing the hydraulic fluid fill plug when the electrical power is removed from the actuator. The fluid level should be within 50 mm (2") of the fluid fill plug sealing face of the tank. If it is necessary to top up hydraulic fluid ensure that the correct type of fluid is used. See actuator name plate. It may be necessary to remove the actuator from the valve to carry this out.
- If the fluid level is low, visually inspect the actuator and tighten any hydraulic fittings that may be leaking.
- Check the operating speeds in both the open and closed directions by conducting a full-stroke test.
- Fully open the actuator and turn the red local control knob to stop. Leave the actuator for 30 minutes and check that the actuator has not drifted off the open limit.

Routine maintenance should include the following after five years of service:

- The hydraulic fluid and filter should be replaced (Refer to Weights and Measures, section 11, for the volume of fluid required).
- The actuator seals should be replaced.

9.2 Replacing the Filter

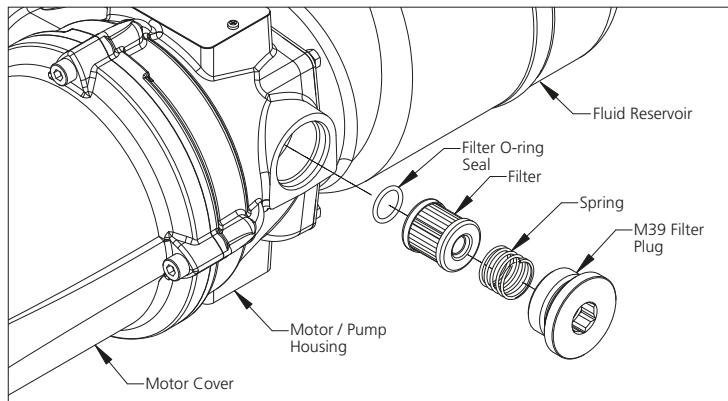

Fig. 9.2.1. SI Actuator without an Accumulator

⚠ WARNING: Before replacing the filter, ensure that there is no pressure in the system and power is disconnected.

The filter for actuators without an accumulator is located in the motor / pump housing as shown in figure 9.2.1.

The filter for actuators with an accumulator is located in the manifold.

Using a 17 mm Allen (hex.) key, unscrew the M39 filter plug. Pull out the spring and filter from the cavity. Renew the filter O-ring seal and ensure it is located in its groove at the bottom of the cavity. Place the new filter into the cavity with the sealed end facing outwards. Fit the spring on top of the filter, screw the M39 filter plug back in place and tighten.

9.3 Replacing the Hydraulic Fluid

Hydraulic fluid can be added to the system by unscrewing the fluid fill plug. By using an appropriately sized funnel, fluid can be poured into the reservoir. Ensure that the fluid is cleaned through a 3 micron filter as it is added into the reservoir, this will reduce the chance of contamination.

When conducting a complete fluid change, the system must be purged before filling again. Please see the workshop manual for further details.

The following fluids are used in SI3 and SI4 actuators:

Standard Applications

32 cST Mineral Oil

Fuchs Renolin CL32

Unless specially ordered for extreme climate conditions or other special environments, Rotork SI actuators are dispatched filled with 32 cST mineral oil. Suitable for actuators operating in ambient temperatures from:

-15 to +70 °C (+5 to +158 °F)

Low Temperature Environments

32 cST Synthetic Oil

Fuchs Renolin Unisyn OL32

Suitable for actuators operating in ambient temperatures from:

-30 to +70 °C (-22 to +158 °F)

Super Low Temperature Environments

Consult Rotork for suitable fluids for operation in ambient temperatures from:

-50 to +40 °C (-58 to +104 °F)

Please consult Rotork for fluid compatibility before using another fluid with SI actuators.

9.4 Approved Fuses

Only the following fuses should be used. Please see actuator wiring diagram.

Rating	Part	Location	Fuse
4.00 A	FS1	AC Adaptor Board	Littelfuse 0213004. MXP
3.15 A	FS2	Transformer Wiring	Schurter 0034.3122

10. Decommissioning and Environmental Considerations

End user advice on disposal at end of life of product.

In all cases check local authority regulation before disposal.

The actuator can be removed by reversing the operations detailed in the mounting and cabling sections.

All warnings as detailed in the mounting and cable connection sections must be followed. Disposal of the actuator or any of its components should be done in accordance with the table below.

⚠ WARNING: It is essential that the actuator is not subject to any valve / system loads at the time of removal as this could cause operator injury due to the actuator moving unexpectedly.

Subject	Definition	Remarks / examples	Hazardous	Recyclable	EU Waste Code	Disposal
Electrical & Electronic Equipment	Printed circuit boards	All products	Yes	Yes	20 01 35	Use specialist recyclers
	Wire	All products	Yes	Yes	17 04 10	
Glass	Window	SI display window	No	Yes	20 01 02	Use specialist recyclers
Metals	Aluminium	Power unit castings, covers & manifold	No	Yes	17 04 02	Use licensed recyclers
	Copper/Brass	Wire & motor windings	No	Yes	17 04 01	
	Steel	Actuator body, spring can & cylinder	No	Yes	17 04 05	
	Stainless steel	Indication shaft, manual override shaft, manifold valves & plugs, piping.	No	Yes	17 04 05	
	Mixed metals	SI motor	No	Yes	17 04 07	
Plastics	Glass filled nylon	Electronics chassis & mezzanine cover	No	No	17 02 04	Disposal as general commercial waste
	Polycarbonate	Indication beacon	No	Yes	17 02 03	Use licensed recyclers
Hydraulic Fluid	Mineral	Standard actuator	Yes	Yes	13 02 04	This will require special treatment before disposal, use specialist recyclers or waste disposal companies.
	Food grade	Food industry applications	Yes	Yes	13 02 08	
Rubber	Seals & O-rings	Cover, shaft and hydraulic seals	Yes	No	20 01 99	May require special treatment before disposal, use specialist waste disposal companies

11. Weights and Measures

11.1 SI3 Actuators

The following table gives the weight and volume of hydraulic fluid used in the standard range of SI3 actuators.

Actuator Model	Weight – kg (lbs)	Vol. of Fluid – ltr (US Gal)
SI3-030-035*/C0	82 (181)	4.56 (1.2)
SI3-030-035*/C1	81 (179)	4.56 (1.2)
SI3-060-045*/C2	95 (209)	4.61 (1.22)
SI3-120-060*/C3	151 (333)	4.74 (1.25)
SI3-240-070*/C2	174 (383)	4.93 (1.3)
SI3-240-070*/C3	174 (383)	4.93 (1.3)
SI3-085S-050*/C2D	234 (515)	4.87 (1.29)
SI3-085*-060*/*3D	293 (645)	5.1 (1.35)
SI3-085*-070*/*6D	321 (707)	5.2 (1.37)
SI3-085*-080*/*7D	377 (803)	5.5 (1.45)
SI3-100C-080*/*2D	430 (946)	5.4 (1.43)
SI3-130*-080*/*1D	600 (1320)	5.9 (1.56)
SI3-130S-090*/*5D	830 (1826)	6.2 (1.64)
SI3-130*-100*/*6D	882 (1941)	6.7 (1.77)
SI3-161*-100*/*2D	1353 (2977)	6.9 (1.82)
SI3-161*-110*/*3D	1305 (2871)	7.5 (1.98)
SI3-161*-125*/*4D	1470 (3234)	8.5 (2.25)

11.2 SI4 Actuators

Due to the contract specific nature of SI4 equipment, please refer to contract documentation for details of weights and volume of hydraulic fluid.

12. Vibration, Shock and Noise

Standard SI range actuators are suitable for applications where vibration and shock severity does not exceed the following:

Type	Level
Plant induced vibration	1 g rms total for all vibration within the frequency range of 10 to 1000 Hz
Shock	5 g peak acceleration
Seismic	2 g acceleration over a frequency range of 1 to 50 Hz if it is to operate during and after the event
Emitted noise	Independent tests have shown that at 1 m generated noise does not exceed 75 dB(A)

13. SI Approvals

 The SI3 and SI4 Range of Electro-Hydraulic Actuators have extensive options available, unit specific approval details should be confirmed against the actuator data label and contract specific documentation.

WARNING:

1) Certification temperatures are not operating temperatures, see actuator nameplate for operating temperatures.

2) Do not place into service where an external heat source combined with the ambient temperature will exceed either the upper or lower operating temperatures.

United Kingdom – Hazardous Area

UKEX (2016 No. 1107)
II 2 G

Ex db ① h IIB T4 Gb

Ex db ① h IIC T4 Gb

T ambient = ② up to +70°C

① “eb” added on variants with the increased safety terminal enclosure option

SI3 and SI4 (Manifold Configuration 1)

② Down to -50°C, Group IIB & IIC

SI4 (Manifold Configuration 2)

② Down to -50°C, Group IIB

② Down to -20°C, Group IIC

Certificate: CSAE 21UKEX1430X

Europe – Hazardous Area

ATEX Directive (2014/34/EU)
II 2 G

Ex db ① h IIB T4 Gb

Ex db ① h IIC T4 Gb

T ambient = ② up to +70°C

① “eb” added on variants with the increased safety terminal enclosure option

SI3 and SI4 (Manifold Configuration 1)

② Down to -50°C, Group IIB & IIC

SI4 (Manifold Configuration 2)

② Down to -50°C, Group IIB

② Down to -20°C, Group IIC

Certificate: Sira 15ATEX1119X

International – Hazardous Area

IECEx (IEC 60079-0, IEC 60079-1 & IEC60079-7)

Ex db ① IIB T4 Gb

Ex db ① IIC T4 Gb

T ambient = ② up to +70°C

① “eb” added on variants with the increased safety terminal enclosure option

SI3 and SI4 (Manifold Configuration 1)

② Down to -50°C, Group IIB & IIC

SI4 (Manifold Configuration 2)

② Down to -50°C, Group IIB

② Down to -20°C, Group IIC

Certificate: IECEx SIR 15.0046X

Canada & USA – Hazardous Area

cCSAus (Class 2258-06 & 2258-86)

Canada:

Ex db ① IIB T4 Gb

Ex db ① IIC T4 Gb

USA:

Class 1, Zone 1 AEx db ① IIB T4 Gb

Class 1, Zone 1 AEx db ① IIC T4 Gb

T ambient = ② up to +70°C

① “eb” added on variants with the increased safety terminal enclosure option

SI3 and SI4 (Manifold Configuration 1)

② Down to -40°C, Group IIB & IIC

SI4 (Manifold Configuration 2)

② Down to -40°C, Group IIB

② Down to -20°C, Group IIC

Certificate: CSA 17CA70005775X

China – Hazardous Area

CCC (CNCA-C23-01:2019)

GB/T 3836.1-2021, GB/T 3836.2-2021,
GB/T 3836.3-2021

Ex db ① IIB T4 Gb

Ex db ① IIC T4 Gb

T ambient = ② up to +70°C

① “eb” added on variants with the increased safety terminal enclosure option

SI3 and SI4 (Manifold Configuration 1)

② Down to -50°C, Group IIB & IIC

SI4 (Manifold Configuration 2)

② Down to -50°C, Group IIB

② Down to -20°C, Group IIC

Certificate: 2021322307003808

India – Hazardous Area

CCoE (Petroleum Rules 2002)

Ex db IIB T4 Gb

Ex db IIC T4 Gb

T ambient = ① up to +70°C

SI3 and SI4 (Manifold Configuration 1)

① Down to -50°C, Group IIB & IIC

SI4 (Manifold Configuration 2)

① Down to -50°C, Group IIB

① Down to -20°C, Group IIC

Certificates:

P550926 (SI3 IIB), P550925 (SI3 IIC),
P550924 (SI4 IIB), P550923 (SI4 IIC)

EAC – Hazardous Area

Incl. Armenia, Kazakhstan & Kyrgyzstan

EAC (TR TS 012/2011)

1 Ex d ① IIB T4 Gb

1 Ex d ① IIC T4 Gb

T ambient = ② up to +70°C

① “e” added on variants with the increased safety terminal enclosure option

SI3 and SI4 (Manifold Configuration 1)

② Down to -50°C, Group IIB & IIC

SI4 (Manifold Configuration 2)

② Down to -50°C, Group IIB

② Down to -20°C, Group IIC

Certificate: RU C-GB.HB07.B.00088/20

UK & EU – Non-Hazardous Area

BS EN 60529:2013

IP66/68 (7 m for 72 hrs)

International – Non-Hazardous Area

IEC 60529:2013

IP66/68 (7 m for 72 hrs)

Canada & USA – Non-Hazardous Area

Class 2252-06 & 2252-86 (Process Control Equipment)

Canada:

CSA/CAN-C22.2 No. 61010-1-12
(Update 1 & 2)

USA:

UL 61010-1 3rd Edition (Update 1 & 2)

Enclosure:

Canada:

CAN/CSA-C22.2 No. 60529:16
IP66/68 (7 m for 72 hrs)

CAN/CSA-C22.2 No. 94.1-15 & 94.2
Type 4 & 6

USA:

ANSI/IEC 60529:04 (R2011)
IP66/68 (7 m for 72 hrs)

UL50 & UL50E

Type 4 & 6

UKCA & CE Marking

Depending on the full actuator configuration, the following UK Regulations or EU Directives may be applicable along with Hazardous Area Regulations and Directions detailed below:

UK - Supply of Machinery (Safety)
Regulation 2008

EU - Machinery Directive 2006/42/EC

The SI3 and SI4 are considered to be partially complete machinery, equipment incorporating the SI3 and SI4 must not be put into service until the complete equipment assembly has been suitably assessed.

UK - Radio Equipment Regulation 2017

EU - Radio Equipment Directive 2014/53/EU

The SI3 and SI4 are suitable for use in industrial EMC environments.

UK - Pressure Equipment (Safety)
Regulations 2016

EU - Pressure Equipment Directive
2014/68/EU

14. Functional Safety

The SI3 and SI4 Range of Electro-Hydraulic Actuators are designed in accordance with IEC 61508: 2010; see separate safety manual for full details.

15. Approved Supply Ratings

 **For specific units, supply ratings should be verified against the data label**

The following symbols marked on the equipment are used to indicate the type of supply

≡ DC supply (+ve, -ve & PE conductors)

~ Single phase supply (2 x phase & PE conductor)

3~ Three phase supply (U, V, W phase & PE conductor)

SI3 and SI4 with integrated motor

≡ 24 VDC, max. 0.29 kW

~ 110-120 VAC 60 Hz, max. 1.34 kVA

~ 230 VAC 50 Hz, max. 0.97 kVA

~ 230 VAC 60 Hz, max. 1.25 kVA

3~ 380-440 VAC 50/60 Hz, max. 1.66 kVA

3~ 480-575 VAC 60 Hz, max. 1.66 kVA

SI4 with optional third party motor

All voltages, maximum power up to 5.5 kW

(see also 3rd party manufacturer/contract documentation)

Duty: Isolating or Intermittent (300 Starts/Hour - 75% duty up to +40 °C or 40% duty above +40 °C).

rotork®



PUB021-057-00

UK

Rotork plc

tel +44 (0)1225 733200

email mail@rotork.com

USA

Rotork Controls Inc.

tel +1 (585) 247 2304

email info@rotork.com

A full listing of our worldwide sales and service network is available on our website.

www.rotork.com

Original instructions: English language version only. As part of a process of on-going product development, Rotork reserves the right to amend and change specifications without prior notice. Published data may be subject to change. For the very latest version release, visit our website at www.rotork.com

The name Rotork is a registered trademark. Rotork recognises all registered trademarks. The Bluetooth word mark and logos are registered trademarks owned by Bluetooth SIG, Inc. and any use of such marks by Rotork is under license. Published and produced in the UK by Rotork. POLJB0624

PUB021-057-00
Date of issue 06/24
