

rotork[®]

Group Products and Services



Intelligent Flow Control Solutions

Reliability in critical flow control applications

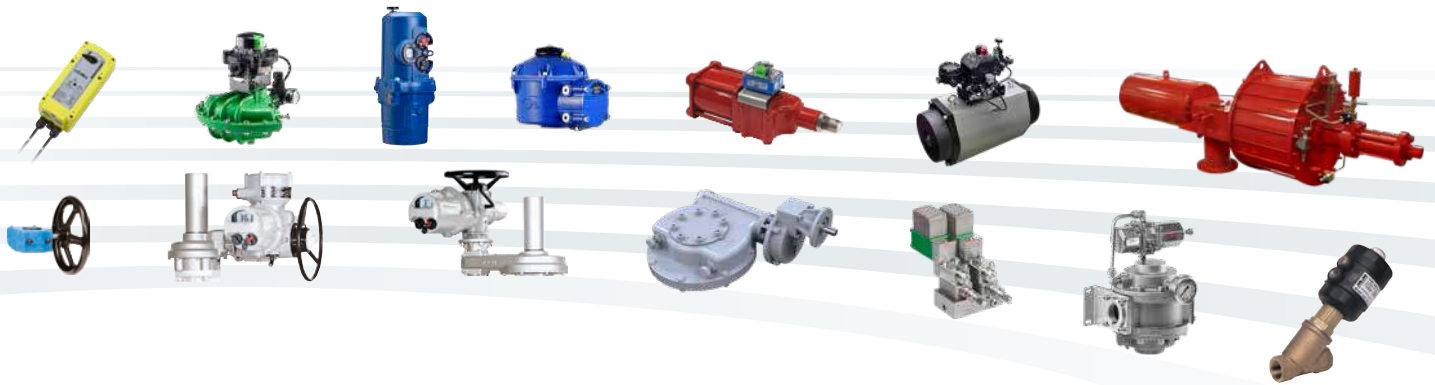

› Reliable operation when it matters

Assured reliability for critical applications and environments. Whether used infrequently or continuously, Rotork products will operate reliably and efficiently.

› Quality-driven global manufacturing

We offer products that have been designed with over 60 years of industry and application knowledge.

Our research and development ensures cutting edge products are available for multiple applications across multiple industries.

› Customer focused service and worldwide support

Rotork solve customer challenges and develop new solutions that are tailored to the needs of our clients.

We offer dedicated, expert service and support from initial inquiry, to product installation, to long-term after-sales care.

› Low cost of ownership

Long-term reliability prolongs service life.

Rotork helps to reduce long-term cost of ownership and provides greater efficiency to process and plant.

Group Products and Services

Section	Page	Section	Page
Introduction	4	Network Control Systems	17
Global Markets	6	Valve Gear Operators and Accessories	20
Oil & Gas	6	Fluid Power Actuators and Control Systems	30
Water & Power	7	Instrumentation and Control	38
Chemical, Process & Industrial (CPI)	7	Site Services	44
Electric Actuators and Control Systems	8	Lifetime Management	46



Comprehensive product range serving multiple industries

Rotork products offer improved efficiency, assured safety and environmental protection across sectors such as the Power, Oil & Gas, Water & Wastewater, HVAC, Marine, Mining, Pulp & Paper, Food & Beverage, Pharmaceutical and Chemical sectors.

Market leaders and technical innovators

We have been the recognised market leader in flow control for over 60 years.

Our customers rely upon Rotork for innovative solutions to safely manage the flow of liquids, gases and powders.

Global presence, local service

We are a global company with local support.

Manufacturing sites, service centres and sales offices throughout the world provide unrivalled customer services, fast delivery and ongoing, accessible support.

Environmental, Social and Governance is at the heart of our business

We have a range of policies in place that support our performance across environmental, social and governance topics. The majority of our policies are publicly available.

Introduction



Rotork is a market-leading global provider of mission-critical flow control and instrumentation solutions for oil and gas, water and wastewater, power, chemical, process and industrial applications. We help customers around the world to increase operational efficiency, reduce environmental impacts, improve product quality and provide safer working environments.

Our comprehensive product portfolio and global service capability coupled with over 60 years of industry knowledge means customers can rely on us to understand the problems they face and to deliver reliable, economic solutions.

The innovative research and development activities across Rotork ensure cutting edge products are available for every application, as we solve customer challenges and develop new solutions to create successful and reliable operations.

Rotork has a number of policies in place to help us reduce our environmental impact with a particular focus on energy reduction and managing environmental emissions.

We are committed to the prevention of pollution and comply with legal and regulatory requirements. We reduce our environmental impact by targeting key areas such as energy consumption, water consumption and waste.



Knowledge

Since 1957 Rotork has operated across global markets, delivering intelligent flow control solutions for a wide-ranging suite of industries and market applications.

Quality

Rotork products are designed and built with quality components and clear user interfaces for quick and safe operation in the field.

Reliability

Rotork's rigorous product development and testing ensures long-lasting performance and continued reliability.

Innovation

Through a culture of continual improvement, we ensure our products remain at the cutting edge for every application, providing cost effective and environmentally friendly solutions.

Support

Our global network of local service centres and engineers is unrivalled in the flow control market.

At Rotork, we create innovative and dependable market-leading products and solutions for the flow control market.



Our engineering and application knowledge base, built over 60 years, allows us to provide innovative and reliable solutions for all flow control applications.

We work across the globe, servicing a diverse range of markets and critical applications.

Our experience of flow control is second to none.

Oil & Gas

We understand the challenges of the oil and gas industry. Our innovative products and solutions help meet economic and policy requirements for the safe production of clean energy. Our wide-ranging suite of products, honed and improved through years of research and development, mean we are perfectly situated to assist in all stages: upstream, midstream and downstream.

Building on a wealth of experience, we have the knowledge to offer you the best actuation products possible. We design and produce the actuators, instrumentation and associated flow control equipment that are used in the most vital parts of the oil and gas industries. In all cases, our products provide a high degree of durability, control and safety. From involvement in offshore production platforms and wellheads in upstream, to pipelines and storage tank facilities in midstream, to refining and distillation in downstream, we are the actuation experts in the oil and gas industries that you can rely on.

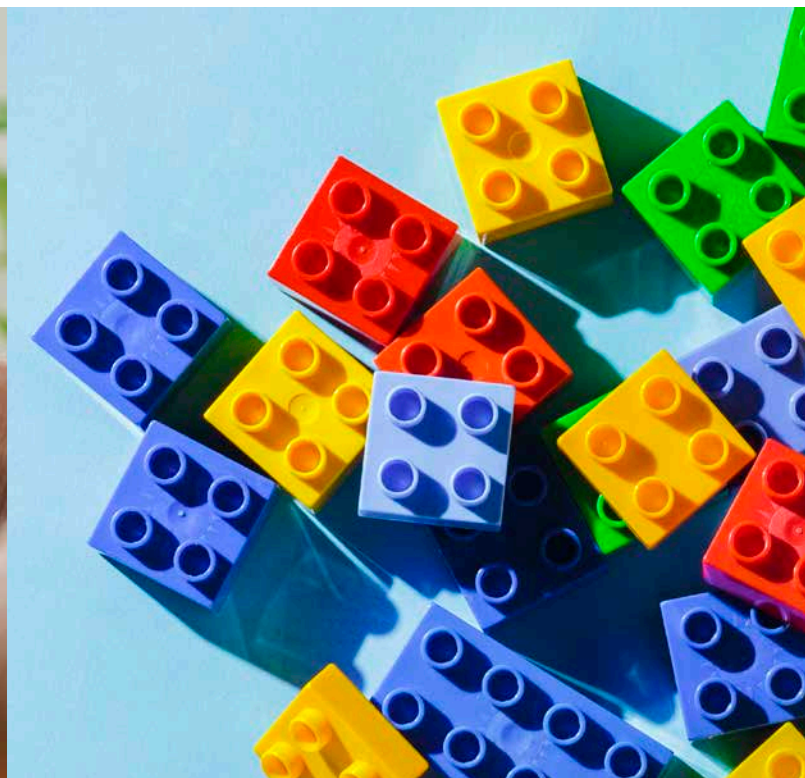

Water & Power

Rotork products control thousands of valves in the water and wastewater industry. Our flow control products are used in potable water treatment including filtration, desalination and distribution. We are involved in level control in dams, reservoirs and irrigation systems. Rotork help protect the environment by controlling wastewater plants, improving effluent processing and ensuring clean, safe output from sewage treatment plants. Rotork is involved in every part of wastewater operations including production of green energy from aerobic and anaerobic processes to sludge handling.

Wherever there is coal, natural gas, nuclear, solar, biomass or geothermal power generated globally, you'll find Rotork flow control products. We help meet the challenges of power generation and have a detailed understanding of the demands and requirements that plant operators face, including diverse applications such as onshore and offshore wind farms and conventional thermal power stations. We specialise in designing and manufacturing actuators and related equipment for every part of the power industry. Our products can withstand harsh environments and unique challenges such as extreme temperatures, hazardous and corrosive substances, vibration and dust.

Chemical, Process & Industrial (CPI)

We have a track record of innovation and proven results in complex applications. Our products provide the exacting levels of durability, reliability and safety that our clients require and our specialist knowledge for isolation, control and flow regulation of liquids and gases provide an essential element in the operation and protection of equipment and machinery across a wide range of markets. We can customise the range of solutions that we offer, dependent on the industry and application or customer requirements.

Whether you are a producer of chemicals for use as lubricants, adhesives or battery and fuel cells; a mining company; a manufacturer of iron, steel and aluminium materials; a producer of paper, glass or cement; or part of the wider manufacturing industry, Rotork can help you meet your goals.

Extending across this broad range of industries which convert key raw materials such as hydrocarbons, minerals and gases in to manufactured products, as well as their safe transportation and storage, Rotork products offer quality and high performance in all applications.

Electric Actuators and Control Systems

Rotork electric actuators are designed and manufactured in strategic global locations such as the UK, USA, Germany, China, Malaysia and India to ensure complete global coverage for all your site needs.

Rotork delivers state of the art cutting edge products to the valve industry including:

- Intelligent valve actuators – multi-turn and part-turn
- Control valve actuators – part-turn / rotary and linear
- Specialist products for HVAC, power station and pump metering applications
- Explosionproof actuators, sensors, switches and controls
- Network control systems

Research and Development

Rotork continually researches new technologies and develops innovative and industry leading products.

We have dedicated research and development centres around the world that all work together to produce the strongest line of valve actuation products available on the market today.

Testing and Quality Assurance

Rotork is recognised for being quality driven and committed to providing our customers with robust and reliable products that meet or exceed their expectations.

We have test facilities located at all of our manufacturing facilities so that every product is tested and qualified before shipment to the customer. Our products are manufactured to comply with stringent quality standards around the world.

All Rotork products are designed and manufactured in accordance with ISO 9001, achieving the highest levels of performance and reliability.

Customer Service - the Rotork Advantage

Rotork provides unparalleled world-class service and support locally to you, wherever you are in the world.

Proud to be recognised as the leader in automation products for challenging critical applications.

Unrivalled record of reliability and assured operation in the harshest environments.

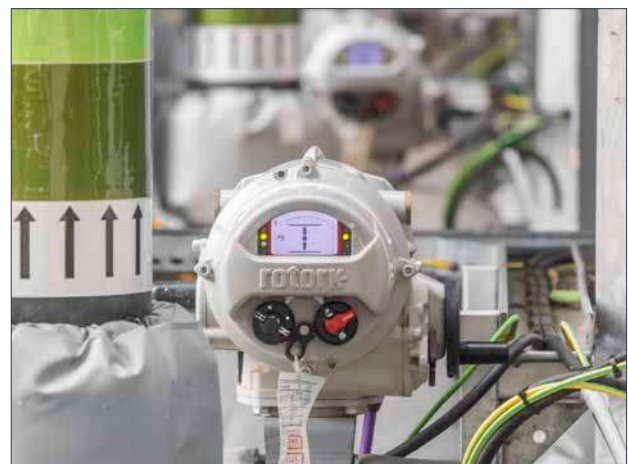

IQ3 Pro range



IQ3 Pro multi-turn and part-turn electric actuators for arduous environments

Unrivalled industry-leading reliability

- Continuous position tracking at all times, even without power
- The graphical interface, remote indication and data logger are maintained and accessible on power loss
- Extended life and mounting in any orientation with oil bath lubrication
- Water ingress protection, not reliant on terminal cover or cable gland sealing – double-sealed to IP66/68
- Built-in protection by using independent torque and position sensing
- Safe, motor-independent, handwheel operation at all times
- Explosionproof and certified for safety applications (SIL2/3)
- Drive bush bearings sealed for life – no maintenance required
- Integral plug and socket connections available
- Mechanical position indication available

Simple, secure commissioning and configuration

- Rapid and secure commissioning and configuration even without power
- Non-intrusive setting in any environmental conditions using the intrinsically safe Rotork Bluetooth® Setting Tool Pro, Rotork app or Manual Setup using local control knobs
- Rotork app features include a valve configuration wizard
- Easy installation and valve maintenance using detachable thrust bases
- Auto set up function on part-turn variants
- Multilingual backlit display

Asset management and preventative maintenance

- Real-time valve and actuator data viewable on screen and exported to Rotork's intelligent Asset Management (iAM) system for detailed trend analysis and predictive maintenance
- Safe and secure data log download to non-intrusive Rotork Bluetooth® Setting Tool Pro and the Rotork app
- Field upgradeable and configurable control and indication options using setting tool
- Compatible with Pakscan™ control and monitoring system, all leading field bus networks and legacy control systems

IQ Range performance data

- Multi-turn direct drive: 10 to 3,000 Nm (7 to 2,213 lbf.ft)
- Multi-turn with IS or IB gearbox: up to 40,718 Nm (30,030 lbf.ft)
- Part-turn direct drive: 50 to 3,000 Nm (37 to 2,213 lbf.ft)
- Part-turn with IW Mk2 gearbox: up to 826,888 Nm (609,881 lbf.ft)
- Linear thrust range with linear output: up to 112 kN (25,177 lbf)

Power supply options

- 1-phase, 3-phase or DC supplies

See [PUB002-038](#) for further details.

RHS



Remote Hand Station

The Remote Hand Station enables replicated operation, interrogation and configuration of the latest IQ actuators. For use when the actuator is located in a hazardous or inaccessible location.

- Installation using standard data cable, up to 100 m (328 ft) away from the actuator
- Powered from the attached actuator, no need for additional power supply

See [PUB002-056](#) for further details.

Intelligent Integral Non-Intrusive Multi-turn & Linear Actuators



IQ 3-phase

IQ 3-phase electric actuators for isolating, regulating or inching duties (S2 & S3 / Class A & B) of up to 60 starts / hour.

Direct torque output range from 14 to 3,000 Nm (10 to 2,213 lbf.ft). With second stage gearboxes, multi-turn output torque up to 40,718 Nm (30,030 lbf.ft) and part-turn up to 826,888 Nm (609,881 lbf.ft).



IQS 1-phase

IQS actuators are 1-phase versions of IQ actuators.

Direct torque range from 10 to 450 Nm (7 to 332 lbf.ft). With second stage gearboxes, multi-turn output torque up to 9,756 Nm (7,196 lbf.ft) and part-turn up to 208,000 Nm (153,413 lbf.ft).



IQD direct current

DC powered versions of IQ actuators. Voltage ranges available are 24, 48 and 110 VDC.

Direct torque output range 11 to 305 Nm (8 to 225 lbf.ft). With second stage gearboxes, output torque up to 1,500 Nm (1,106 lbf.ft) and part-turn up to 131,950 Nm (97,321 lbf.ft).



IQH high speed

IQH 3-phase electric actuators provide fast operation with positive seating without back driving. High output speeds and generally irreversible operation provide a self-locking ability.

Speeds up to 259 rpm and torque range 27 to 397 Nm (20 to 293 lbf.ft).



IQM / IQML modulating

Modulating 3-phase electric actuator with solid state reversing starter including an electronic motor 'brake' feature. Fast-response remote control circuits for rapid control.

IQM is suitable for up to 1,200 starts per hour (S4 / Class C). Direct seating torque output range from 11 to 544 Nm (8 to 401 lbf.ft). With second stage gearboxes, output seating torque up to 11,750 Nm (8,666 lbf.ft) and part-turn up to 77,000 Nm (56,790 lbf.ft). IQML has a linear output drive providing seating thrust output of up to 43 kN (9,667 lbf).



IQ SET

IQ SET actuator is backwards compatible to the 1960s. This backwards compatibility is for legacy actuators on your site that have non-integral starters (known as "SyncroSET").

Customers can manage obsolescence concerns by replacing legacy actuators with the latest intelligent IQ3 actuator platform. This allows access to the many benefits an IQ3 brings to modern plant and network design, operation and maintenance. IQ SET is compatible with existing site cabling and control systems.

Intelligent Integral Non-Intrusive Part-turn & Linear Actuators



IQT

IQT part-turn 1-phase, 3-phase and DC electric actuators are designed for isolating or regulating duties (S2 & S3 / Class A & B) of up to 1,200 starts per hour.

Direct torque output range from 50 to 3,000 Nm (37 to 2,213 lbf.ft).

Option: High shock base for Naval applications.



IQTM modulating

IQTM 1-phase, 3-phase and DC electric modulating versions of the IQT actuator are designed for modulating duty up to 1,800 starts per hour (S4 / Class C). They feature fast-response remote control circuits for rapid control.

Torque range 50 to 3,000 Nm (37 to 2,213 lbf.ft).



IQT shutdown battery

The IQT Shutdown Battery option provides fail-to-position functionality for IQT, IQTM and IQTF actuators in the event of a mains power loss. The internal Lithium-ion battery is charged with the actuator mains power supply to ensure a power loss action is always available. Available for Ex and non-Ex applications, actuators can be configured to automatically move to a preset position or remain available for control during the power loss.

Note: Not available with IQT3000.

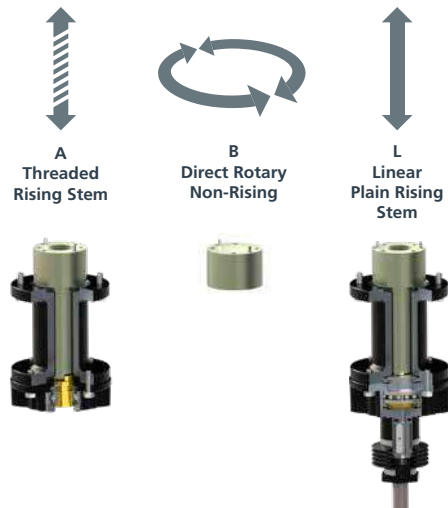

IQTF full-turn modulating

IQTF 1-phase, 3-phase and DC electric modulating actuators are capable of multi-turn, rising output, linear output and direct rotary output. Includes special fast switching control inputs for hardwired control. Modulating duty cycle up to 1,800 starts per hour (S4 / Class C). For full IQTF data please refer to [PUB002-006](#).

A = Torque range 20 to 250 Nm (14.8 to 184.5 lbf.ft)

B = Torque range 20 to 3,000 Nm (14.8 to 2,213 lbf.ft)

L = Thrust range 7.5 to 75.8 kN (1,693 to 17,036 lbf)

The drive outputs conform to actuator interface standards EN ISO 5210 for multi-turn and BS EN 15714-2 for linear.

Special designs

If you require an IQ or IQT actuator for duties that are not covered by our standard range, we are happy to discuss customised solutions.

CK range



CKR (Multi-turn)

CKQA (Part-turn)

Remote mounted Centronik controls

CK modular design multi-turn and part-turn electric valve actuators

CK range actuators are suitable for valves in non-hazardous locations. The modular product range facilitates a number of different control package configurations to meet your application requirements.

- Modular design provides an off-the-shelf solution for spares and upgrading
- Plug and socket connection for easier field wiring
- Continuous valve position indication even during power loss
- Non-intrusive setting via infrared or optional Bluetooth with the intelligent CKc - Centronik module
- Hollow output drive to accept rising valve stems
- Detachable base options
- Secure, padlockable, manual handwheel drive fully independent of the motor drive train
- IP68 rating as standard provides enhanced environmental protection
- Extended life with oil bath lubrication

CK Multi-turn actuator performance

- Direct output torque range: 10 - 500 Nm (7 - 369 lbf.ft)
- Max. torque with standard multi-turn gearbox: 6,750 Nm (4,979 lbf.ft)
- Max. torque with standard part-turn gearbox: 205,600 Nm (151,643 lbf.ft)

CKQ Part-turn actuator performance

- Direct output torque range: 54 - 1,000 Nm (40 - 738 lbf.ft)

CK & CKR actuators

Multi-turn actuators comprising electric motor, drive gearing, independent handwheel drive, torque and position limit control & indication with plug and socket field wiring correction. The CK range provides the right solution for users with centralised motor control centres or for high temperature and sustained vibration applications.

CKQ actuators

Part-turn actuators for users with centralised motor control centres or high temperature and/or sustained vibration applications. They are designed for part-turn on/off valve types that are infrequently operated.

CKA, CKRA & CKQA actuators

The Atronik control module provides reliable motor starter with modest integral controls to meet the standard requirements of site specification. Simple status indication and DIP switch configuration ensure quick commissioning and installation on site.

CKc, CKRc & CKQc actuators

The Centronik control module provides intelligent, integral control for use with all site control systems. It permits the use of hardwired, fieldbus or analogue control & indication, offering cost-effective implementation with centralised control systems. Centronik actuators allow valvemakers/integrator testing with just the power supply, using local control with no extra wiring or motor control gear required. Non-intrusive, password protected configuration may be carried out using open/close selector switches or by using the optional Rotork Setting Tool, over the infrared or optional Bluetooth interfaces. The Centronik display provides position indication, status and alarms for operation plus simple menu-driven configuration screens.

See [PUB111-001](#) for further details.

Precision Modulating Actuators

CMA range



CML 1500/3000 (Linear)

CML (Linear)

CMQ (Part-turn)

CMR (Multi-turn)

Linear, part-turn and multi-turn actuators

The CMA delivers a range of sizes suitable for almost all linear, part-turn and multi-turn control valves and other applications requiring exact position control and continuous modulation. Suitable for demanding applications including control valves, metering and dosing pumps.

- Powered by 1-phase or DC supplies
- Continuous modulation to S9 (IEC 60034), Class D duty (ISO 22153)
- Optional local controls including positional display
- Optional Reserve Power Pack (RPP) including local controls and positional display

- Permanently lubricated and maintenance-free drive train
- Optional configurable ESD input for end of travel or stayput emergency shutdown function
- Accurate and repeatable position control
- 4-20 mA loop powered feedback signal
- Linear: up to 20 kN (4,500 lbf) seating thrust
- Part-turn: up to 124 Nm (1,100 lbf.in) seating torque
- Multi-turn: up to 28 Nm (250 lbf.in) rated torque

See [PUB094-001](#) for further details.

CVA range

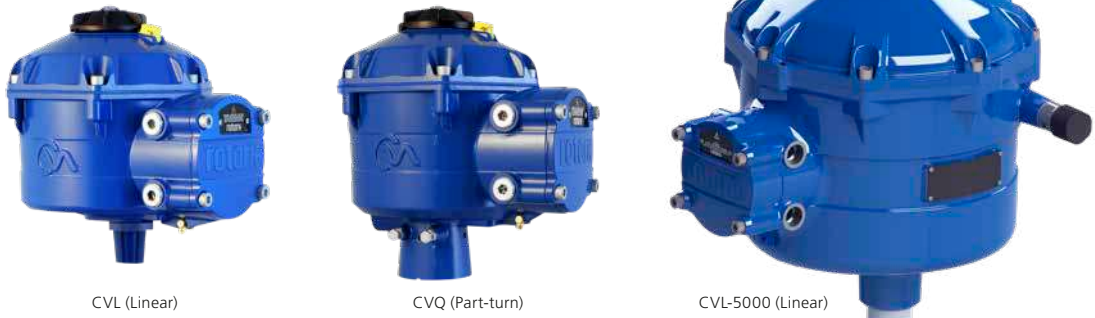

CVL (Linear)

CVQ (Part-turn)

CVL-5000 (Linear)

Linear and part-turn precision modulating actuators

- Compact, viable alternative technology when good quality instrument air is not available in hazardous areas
- Ultra-low energy consumption, suitable for solar powered applications
- 1-phase and DC power supply options
- Continuous, unrestricted modulation to S9 (IEC 60034), Class D duty (ISO 22153)
- Unparalleled accuracy, repeatability, resolution and stiffness
- Perfect for demanding applications including control valves and metering pumps
- Comprehensive data logging
- Programmable fail-to-position option

- Analogue, digital and network control options
- *Pakscan*[™], HART[®], Profibus[®], Foundation Fieldbus[®] and Modbus[®] available
- Optional hardwired control
- Watertight IP68, NEMA 4 & 6, and explosionproof enclosures
- Option of intrinsically safe I/O connections
- Non-intrusive setup / calibration using Bluetooth wireless technology
- Optional manual override
- CVL Linear: thrust range 890 to 22,241 N (200 to 5,000 lbf)
- CVQ Part-turn: torque range 22 to 271 Nm (480 to 2,400 lbf.in)

See [PUB042-001](#) for further details.

ExMax range



Part-turn explosionproof valve actuators

Compact, robust and lightweight electric part-turn valve actuator, designed for use in Ex areas for all gases, mists, vapours and dust.

- On/off duty as standard
- 24-240 VAC/VDC universal power supply
- Standard ISO flanges available
- Torque range 5 to 150 Nm (3.7 to 110.6 lbf.ft)
- Explosionproof to international standards
- UL and CSA certified variants available
- Auto setup and selectable speeds
- Mechanical position indication
- Failsafe option
- Ingress protection IP66/67
- Stainless steel housing option
- Temperature range: -40 to +50 °C (-40 to +122 °F)

See [PUB113-003](#) for further details.

ExReg range



HVAC explosionproof control systems

ExReg controller system has been designed for use in Ex areas for all gases, mists, vapours and dust. In combination with Ex-Max actuators it is a closed loop control system for volume flow control (VAV, CAV), pressure, temperature and humidity.

- Operating temperature range -20 to +50 °C (-4 to +122 °F)
- Measurement differential pressure range 0 to 300 Pa
- Measurement temp. range -40 to +125 °C (-40 to +257 °F)
- Measurement humidity range 0 to 100% rH
- 1-phase and DC power supply options
- Stainless steel housing option
- Certificates: ATEX, IECEx, CSA and others
- Water and dust-tight IP66 rating, integrated junction box
- Integral PID loop
- Pre-defined parameter sets for the most common control tasks
- Can be configured on site in the hazardous location

See [PUB113-001](#) for further details.

ExMax+Lin/ ExRun range



Linear explosionproof actuators

ExMax + LIN and ExRun electric linear valve actuators are designed for use in Ex areas for all gases, mists, vapours and dust. ExMax + LIN with spring-return safety function.

- Thrust range 500 to 10,000 N (112 to 2,248 lbf)
- Certificates: ATEX, IECEx, CSA, Inmetro, Kosha, EAC and others
- Optional spring-return configuration (3, 10 or 20 seconds)
- Control modes: On-off, 3 pos., modulating (0-10 VDC, 4-20 mA), depending on type
- 1-phase and DC power supply options
- Water and dust-tight IP66 rating
- Stainless steel housing option for ExMax
- Temperature range: -40 to +50 °C (-40 to +122 °F)
- Optional extras: Ex-d auxiliary switch with 2 adjustable contacts (2 mounting options available), Ex-e terminal box, manual override

See [PUB113-001](#) for further details.

ExCos/ ExBin range



HVAC explosionproof sensors and switches

ExCos analogue sensors and ExBin binary switches are designed for direct use in hazardous locations. No additional modules in the panel are required. No intrinsically safe wiring is required. All parameters are adjustable on site without additional tools or measuring devices. Sensors and switches for pressure, differential pressure, temperature and humidity are available. Explosionproof design for all gases, mists, vapours and dust.

- Operating temperature range -20 to +50 °C (-4 to +122 °F)
- Measurement pressure range 0 to ±7,500 Pa
- Measurement temp. range -40 to +125 °C (-40 to +257 °F)
- Measurement humidity range 0 to 100% rH
- DC power supply
- Stainless steel housing option
- Certificates: ATEX, IECEx, CSA, Inmetro, Kosha, EAC and others
- Water and dust-tight IP66 rating, integrated junction box

See [PUB113-001](#) for further details.

Specialised Actuators

SM-6000

range



Heavy-duty rotary actuators

- Up to 313° rotation
- Torque range up to 35,252 Nm (26,000 lbf.ft)
- Double O-ring sealing
- Continuous unrestricted modulating duty
- HART®, Profibus® and Foundation Fieldbus® available
- Temperature range: -40 to +85 °C (-40 to +185 °F)
- Automatic torque limiting
- Self-locking drive system to hold in last position and prevent backdriving
- Manual override standard

See [PUB052-001](#) for further details.

LA-2000

range

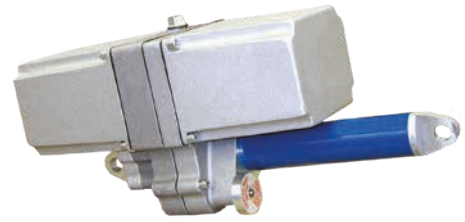

Heavy-duty linear actuators

- Stroke distance from 6" to 30" (152 to 762 mm)
- Thrust range up to 27,335 N (6,150 lbf)
- Modulating duty: 2,000 starts per hour
- HART® available
- Temperature range: -40 to +65 °C (-40 to +150 °F)
- Automatic thrust limiting
- Self-locking drive system to hold in last position and prevent back driving up to thrust rating
- ATEX approved for LA-2520
- Manual override standard

See [PUB045-002](#) for further details.

PAX1 / PAXL

Compact Actuation
and Regulators



Compact low power actuators and regulator controllers

The PAX₁ is a low voltage DC or AC powered regulator controller with a rotating linear thrust rod output optimised to control regulators up to 25 mm (1") stroke.

The PAX_L converts the rotating linear output of PAX₁ to a bi-directional non-rotating linear output optimised for automation of small valves, pumps and other devices.

PAX₁ and PAX_L are suitable for use in hazardous areas due to the fully-sealed explosionproof enclosure.

- Operation speed up to 60 mm/min (2.36 inch/min)
- Maximum thrust of 2,890 N (650 lbf)
- Control pressures up to 20,684 kPa (3,000 psig)
- IP rating IP66 / IP68
- NEMA rating Type 4X / Type 6P
- FM, CSA, CCC/NEPSI, ATEX, IECEx, UKEX hazardous areas
- Ambient temperature range: -40 to +80 °C (-40 to +176 °F)
- Less than 1 Watt power consumption during standby, ideal for remote solar applications
- Optional isolated 4-20 mA position feedback
- Configurable stroke limits

See [PUB136-001](#) for further details.

ROM / ROMpak

range



Part-turn actuators

Compact, lightweight, part-turn actuator with efficient and simple gearing.

- On/off duty; manual override; self-locking; ISO flanges
- Available with local controls and phase rotation correction
- Torque range 8 to 800 Nm (6 to 590 lbf.ft)
- Wide range of supply voltages available
- 1-phase, 3-phase and DC power supply options
- Watertight IP68 rating
- High speed variant available
- Mechanical and LED local position indication
- **Options:** Bus communication, analogue control and feedback

See [PUB008-001](#) for further details.

Q

range



Part-turn actuators

Small, electro-mechanical part-turn actuator environmentally sealed to IP68.

- Torque range 40 to 900 Nm (30 to 664 lbf.ft)
- Rugged compact, double-sealed
- Positive travel limitation through externally adjustable mechanical stops
- 1-phase power supply
- Marine option
- Simple remote control for basic applications
- **Options:** Bus communication, analogue control and feedback

See [PUB007-007](#) for further details.

Local Hand Station



Robust actuator control panel

The Local Hand Station is a fully enclosed control panel, optimised to control actuators and field devices in hazardous, inaccessible or unpleasant locations. The Local Hand Station provides a simple interface between the actuator and DCS, ensuring that localised maintenance activities can be performed safely with no fear of unexpected operation. Critical status information is displayed through the bright LED indicators for maximum visibility to site operators.

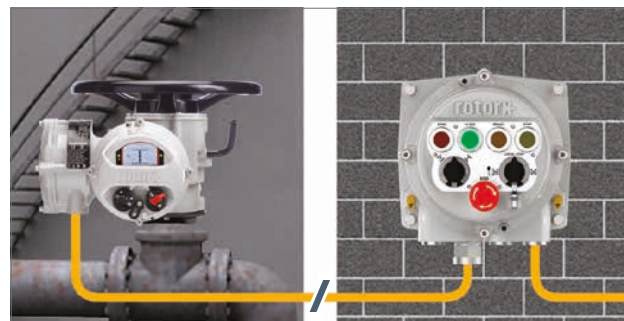

The Local Hand Station is designed for wall or pole mounting to suit any application.

Suitable for use in:

- Hazardous area certified ATEX, IECEx, BIS, PESO
- IP rating IP68
- Temperature: -20 to 70 °C (-4 to +158 °F)

See [PUB169-002](#) for further details.

Network Control Systems

Integration of the plant controls using network connectivity has been a hallmark of Rotork's actuator products for many years. The use of field networks makes the commissioning of a plant, and the subsequent control and monitoring, a simple and reliable task.

All Rotork actuators are compatible with a wide range of communication and process controls systems by including the appropriate option card. The actuator reports status feedback, via the field highway, to the overall plant control system (DCS or PLC) and valve control commands are actioned.

Our own *Pakscan*TM system complements the open systems from Foundation Fieldbus®, Profibus®, Modbus®, HART® and DeviceNet®. Innovative technology together with expert bus system knowledge ensures that Rotork can always provide the ideal solution for your site control system.

A full listing of our worldwide sales and service network is available on our website at www.rotork.com

Modern facilities require up-to-date communications 24 hours a day, right down to plant level.

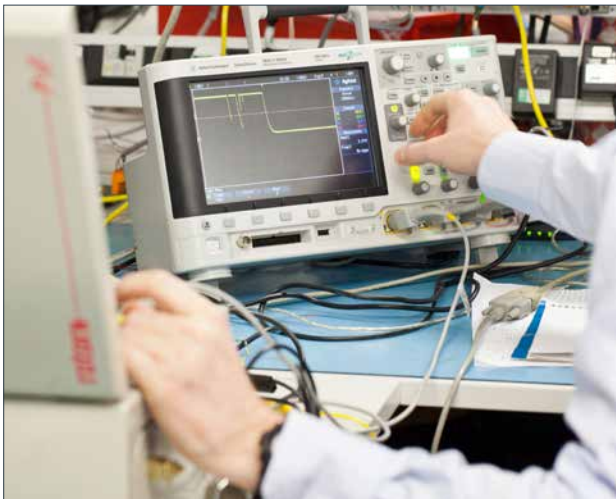

Rotork *Master Station*

The Rotork *Master Station* provides a state-of-the-art control interface for your *Pakscan* and Modbus network loops.

Now with 30 years installed experience, *Pakscan* has found preference in all industry sectors and many diverse applications.

At the heart of the *Pakscan* system is the Rotork *Master Station*, providing the vital link between the control system and the devices in the field. The field devices are connected to the Rotork *Master Station* using *Pakscan* networks which have been designed for use in industries and applications where robust and reliable plant control and monitoring is required.

***Pakscan*: comprehensive solutions for modern plant control and monitoring.**

- Automatic network monitoring and fault management
- Rotork *Master Station* with hot standby capability
- Redundant, fault tolerant field networks
- Fully pre-configured Rotork *Master Station*
- Intuitive user interface
- Long distance and high device count without the need for external repeaters
- Well recognised, simple Modbus RTU / TCP host communications
- Field and host communication diagnostics
- Built in webpages for full system diagnostics
- Commission field devices without the need for the host control system
- Field networks open to third party devices
- Efficient low cost installation with minimum cost of ownership
- Multiple host connectivity
- Backed by Rotork global support

Rotork Master Station Network Capabilities

Redundant Host Ethernet Modbus TCP connection as standard with optional redundant Host serial Modbus RTU connection available.

rotork[®] Master Station

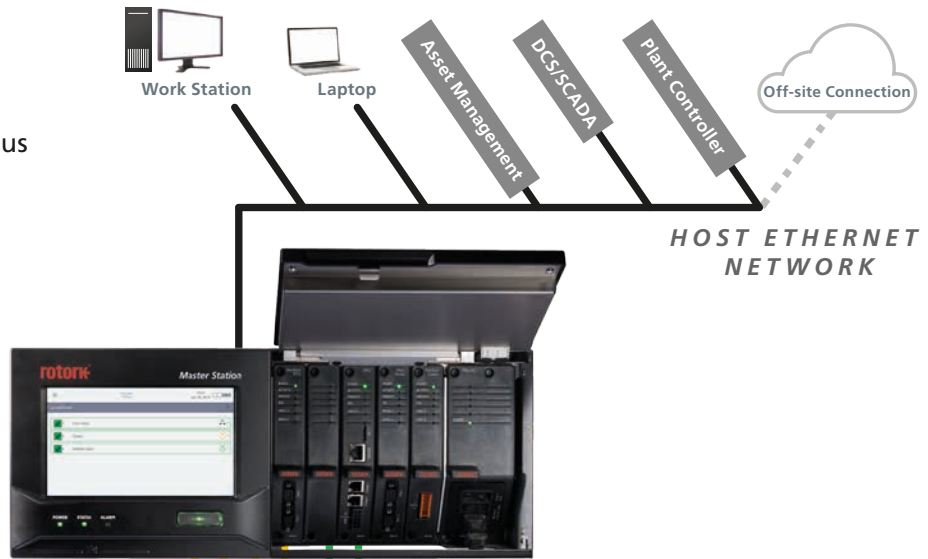

Pakscan[™] CLASSIC

2-Wire Current Loop

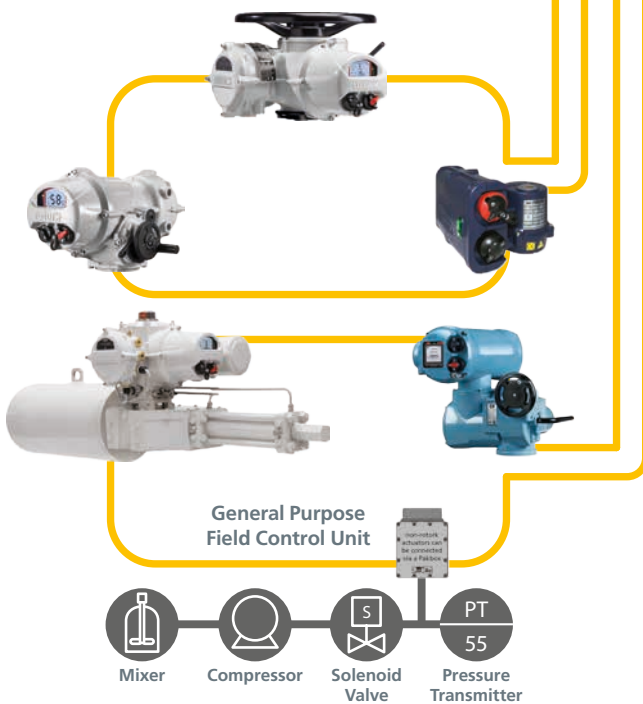

Modbus[®]

Including 3rd Party Field Devices

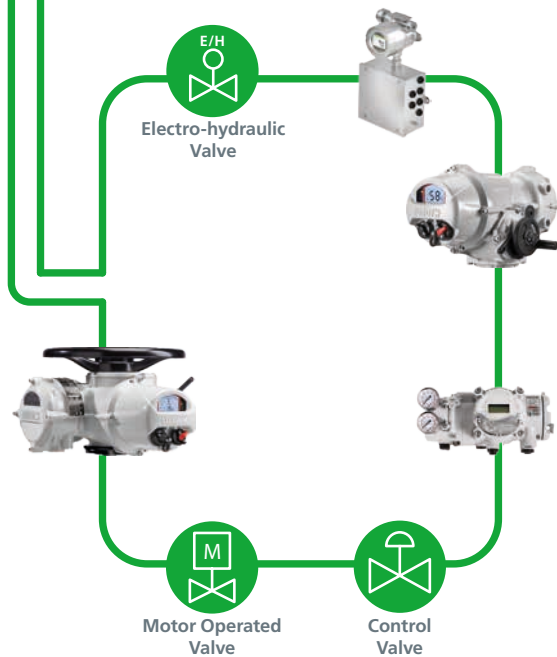

■ Pakscan Classic field network Add In Module (AIM)

The Pakscan Classic redundant loop network has been the network of choice for actuator control for over 30 years. Using robust current loop technology, up to 20 km loop lengths, two independent loops and 240 field devices are possible.

■ Modbus field network Add In Module (AIM)

Modbus field network with standard highway or redundant loop topology options. Other manufacturer's devices are integrated into the network by use of a Rotork field device description file.

Pakscan™ Classic

The *Pakscan* Classic current loop network has now been in service for 30 years, providing numerous plants globally with a robust, reliable valve control system. Over 170,000 field units are operating in the field today. The Rotork *Master Station* and *Pakscan* Classic current loop network are interchangeable with previously-supplied Rotork *Master Station* models, interfacing seamlessly with the systems currently running the plant.

- Long loop length, up to 20 km
- Redundant, single fault tolerant, loop
- High noise immunity, current loop
- Up to 240 field devices, on a single highway
- No external repeaters, highway terminators or biasing
- Open to third party devices
- Fast scan time due to 'report by exception' protocol
- Standard instrumentation cable

HART®

Highway Addressable Remote Transducer (HART) is a process control communication protocol. The HART signal consists of two parts, the analogue 4-20 mA current loop and a superimposed digital (variable frequency) signal. Traditionally the 4-20 mA loop is used for control and the superimposed digital signal for feedback, diagnostics and configuration. Along with the use of standard HART function codes, a DD file describes the device parameters which can be accessed by a host or handheld device. The majority of user-configurable settings can be made over the HART interface.

- Up to 63 devices on each network
- Electronic Device Description (DD) files
- HART 7 compatible

See [PUB092-001](#) for further details.

Foundation Fieldbus®

The Rotork Foundation Fieldbus module connects directly onto the standard Foundation H1 bus system (IEC 61158-1). The ability to report extensive actuator feedback within a single input block, as well as system diagnostic information, makes Rotork the first choice for use with a Foundation Fieldbus system. The device has link active scheduler capability as well as multiple digital and analogue function block capability, inputs and outputs. DD files describe the device capabilities to the host system.

- Foundation ITK inter-operability certified
- Fully compliant with IEC61158-2 standard
- Includes link master and LAS capability
- Independent HIST approval by major DCS vendors
- Full H1 field capability

See [PUB089-001](#) for further details.

Profibus®

Profibus is a leading international network protocol (IEC 61158-3). Rotork's Profibus DP module supports DP-V0 cyclic communications, extended actuator diagnostics and configuration is included in the DP-V1 acyclic data. Single highway and dual highway units, with the DP-V2 redundancy are available. EDD and DTM files allow the Rotork device to be incorporated into asset management systems, whilst the GSD file guarantees device interoperability with all Profibus PLCs.

- RS485 Profibus DP V0 and V1 compliant
- Single and dual redundant options
- Fully compliant with IEC61158-3 standard
- Profibus PNO certified
- Supports speeds up to 1.5 Mbit/s

See [PUB088-001](#) for further details.

Modbus®

Rotork's Modbus module allows actuators to be connected to a 2-wire RS485 network for direct communication to a PLC or DCS using Modbus RTU protocol. Modules are available for standard single and dual (redundant) communication highways. In addition, a redundant loop network can be created with the single and repeater Modbus card. Status, alarms and control functions are available over the Modbus network.

- RS485 2-wire RTU communication
- International open standard
- Single and dual redundant options
- Integral repeater modules included where necessary
- Up to 115 kbps

See [PUB091-001](#) for further details.

DeviceNet®

Devicenet is a communications protocol which utilises the CAN bus network. Rotork's DeviceNet module Electronic Data Sheet (EDS) file is used to set up the actuator parameters to allow the performance of the system to be optimised. Status, alarms and control functions are available over the DeviceNet network.

- Up to 63 devices on each network
- 4-wire cable, 2 for signal, 2 for power
- Trunk and drop line permitted
- ODVA certified to ensure compatibility
- EDS electronic device description file

See [PUB090-001](#) for further details.

Ethernet Systems

Many Rotork devices are compatible with direct RJ45 Ethernet connection to systems such as Modbus TCP, Profinet and Ethernet I/P.

See [PUB002-116](#) for further details.

Valve Gear Operators and Accessories

Rotork are a specialist supplier of gearboxes, adaptations and accessories to the international valve and actuator industry with manufacturing plants in the UK, Netherlands, Italy, China, USA and India.

Rotork offer a wide range of gearboxes spanning the following categories:

- Part-turn output manual gear operators
- Part-turn output motorised gear operators
- Multi-turn output manual gear operators
- Multi-turn output motorised gear operators
- Specialised application gear operators
- Mounting kits and accessories

Engineering and Working Capabilities

Rotork delivers innovative solutions to suit individual needs, backed by Rotork quality and after-sales care.

Advanced application engineering ensures our products are world-class in design and meet or exceed international standards. Quality of our gearbox products is maintained through continuous materials testing and extensive life testing of fully engineered gearbox products.

Testing Facilities

Rotork have extensive multi-turn and part-turn gearbox test facilities at our various manufacturing locations. Rotork in-house testing capabilities include comprehensive performance, endurance, overload and environmental testing to ensure our gearboxes meet the exemplary standards expected by our customers.

Reliability and Quality Assurance

Rotork is committed to fully understanding your needs and expectations and meeting or exceeding these needs. Rotork has an established quality management system that meets the requirements of ISO 9001.

Rotork is committed to:

- Building business success through customer satisfaction
- The promotion and full understanding of customer needs within the organisation
- Continuous improvement of products and customer service operations
- Creating a quality culture by making continuous improvement and quality a fundamental part of every employee's performance and responsibility

Gearboxes and operators designed to withstand harsh environments including subsea installations.

Mounting brackets, extension shafts, pedestals and accessories for the valve and actuator industry.



Gear Operators

232 range



Light-duty worm gear operators

Light-duty cast aluminium part-turn gearboxes suited for HVAC, fire protection, and general industrial applications.

Torque range up to 1,500 Nm (1,106 lbf.ft).
7 sizes. Ratios from 37:1 to 45:1.

- Lightweight
- Rugged construction
- Removable output drive sleeves
- IP65
- High pressure aluminium cast housing
- Protected input shaft

See [PUB034-001](#) for further details.

242 range



Part-turn worm gear operators

Robust and lightweight part-turn cast iron gearbox for low torque manual applications. Suitable for ball, plug and butterfly valves.

Torque range up to 2,000 Nm (1,475 lbf.ft).
5 sizes. Ratios 40:1 and 50:1.

- Worm gear
- Manual drive
- Designed using the latest analytical design tools

See [PUB099-001](#) for further details.

AB range



Part-turn worm gear operators

Heavy-duty cast iron part-turn gearboxes are suited for ball, plug and butterfly valves serving the water, gas, chemical, power, and demanding industrial applications.

Torque range up to 32,000 Nm (23,602 lbf.ft).
15 sizes. Ratios from 34:1 to 729:1.

- Cast iron
- Axial needle bearings
- Rugged construction for all environments
- IP67
- **Options:** Stainless steel input shaft. Ductile iron. IP68. AWWA. Various environments. Padlockable handwheels. Limit switches. High and low temperatures. Buried service. Continuous submersion.

See [PUB033-006](#) for further details.

QTW150 range



Manual part-turn gear operators

Robust, rugged manual gearboxes designed for use in the water and gas pipeline markets.

Torque range up to 150 Nm (111 lbf.ft).
Ratio 40:1.

- Output flange F05 / F07
- Bore Ø 22 mm
- Self-locking gearing
- IP65 minimum sealed unit
- Standard temperature range -20 to +120 °C (-4 to +250 °F)
- Optional padlock

See [PUB131-001](#) for further details.

Gear Operators

IW Mk2 range



High torque part-turn worm gear operators

Part-turn worm gear operators for the operation of ball, plug and butterfly valves. Designed to suit motorised isolating duty applications. Low lead angle gearing to be inherently self-locking. Increased torque output per size compared to IW Mk1.

21 sizes (IW3 to IW13) torque range up to 203,000 Nm (149,725 lbf.ft).

4 sizes (IW14 to IW17) torque range 250,000 to 850,000 Nm (184,391 to 626,927 lbf.ft)

- Comprehensive gear ratios with a selection of auxiliary input spur gear reducers
- Angular contact bearings supporting worm shaft
- Removable and repositionable output sleeve
- Repositionable baseplate facility
- **Options:** High and low temperatures. All types of environment. Flexible extensions.

See [PUB028-079](#) and [PUB029-001](#) for further details.



AB-SS range



Stainless steel gear operators

Heavy-duty stainless steel 316 housing part-turn gearboxes suited for plug, ball and butterfly valves serving the water, gas, chemical and power industries in corrosive environments.

Torque range up to 26,000 Nm (19,177 lbf.ft).
11 sizes. Ratios from 34:1 to 729:1.

- Worm gear
- Manual drive
- Stainless steel 316 housing
- Stainless steel 316 input shaft
- Stainless steel 316 fasteners

See [PUB100-001](#) for further details.

BR range



Bronze worm gear operators

The BR series gear operators are manufactured from high-quality cast aluminium bronze, and stainless steel materials and designed for extended life operation of valves in corrosive manhole and vault steam distribution environments where road salts, standing water and elevated temperatures are common.

Torque range up to 7,000 Nm (5,163 lbf.ft).
3 sizes. Ratios from 34:1 to 217:1.

- Temperature range up to +200 °C (+392 °F)

Contact Rotork for further details.

HOW range



Manual part-turn operators

Part-turn gear operators designed to suit manual applications. For the operation of ball, plug and butterfly valves. Low lead angle gearing to be inherently self-locking.

Torque range 39,000 to 264,000 Nm (28,765 to 194,716 lbf.ft). 9 sizes. Ratios from 1229:1 to 7171:1.

- Ratios chosen to meet manual rim effort requirements
- Protected steel input shaft
- Removable output sleeve
- Ductile iron gearcase
- Angular contact bearings supporting worm shaft
- Repositionable baseplate facility
- **Options:** High and low temperatures. Stainless steel input shaft. All types of environment. Limit switches. Chain wheels. Fixed and flexible extensions.

See [PUB168-001](#) for further details.

ILG-D range



Override part-turn gear operators

Complete range of manual declutchable sandwich override part-turn gearboxes for double-acting pneumatic actuators.

Torque range up to 17,000 Nm (12,539 lbf.ft). 9 sizes. Ratios from 35:1 to 468:1.

- Protected input shaft
- Cast iron housing
- Axial needle bearings
- IP65
- **Options:** High and low temperature. ISO drive coupling. Solenoid valve to evacuate air automatically. IP67.

See [PUB038-001](#) for further details.

ABM range



Motorised part-turn gearboxes

Part-turn devices for the motorised operation of plug, ball and butterfly valves and power and process dampers.

Torque range up to 2,000 Nm (1,475 lbf.ft). 4 sizes. Ratios 34:1 to 200.7:1.

- Supports electric actuator weight up to 46 kg (101 lbs) and a speed up to 96 rpm
- Input: F/FA10
- Ductile iron housing and C45 carbon steel input shaft
- Axial thrust bearings
- Removable insert
- IP67 and ATEX approved
- **Options:** High and low temperatures. Firesafe to ISO 10497. IP68 marinised and buried service.

See [PUB123-004](#) for further details.

ILG-S range



Override part-turn gear operators

Complete range of sandwich manual override part-turn gearboxes for spring-return pneumatic actuators.

Torque range up to 32,000 Nm (23,602 lbf.ft). 10 sizes. Ratios from 34:1 to 729:1.

- Protected input shaft
- Cast iron housing
- Axial needle bearings
- IP65
- **Options:** High and low temperature. ISO drive coupling.

See [PUB039-004](#) for further details.

Gear Operators

ABLX (FM-UL) range



Part-turn worm gear operators

Cast iron part-turn gearboxes with integrated limit switches for remote position indication suited for fire protection.

Torque range up to 1,620 Nm (1,196 lbf.ft).
4 sizes. Ratios from 34:1 to 40:1.

- Cast iron housing
- Rugged construction
- Removable output drive sleeves
- IP67
- Different types of position indicators
- Suitable for FM/UL/APSAD applications

Contact Rotork for further details.

232LX range



Part-turn worm gear operators

Light-duty cast aluminium part-turn gearboxes with integrated limit switches for remote position indication suited for fire protection.

Torque range up to 500 Nm (366 lbf.ft).
2 sizes. Ratios 37:1 to 45:1.

- High pressure aluminium cast housing with stainless steel input shaft
- Lightweight
- Suitable in corrosive environments
- IP65
- Removable output drive sleeves
- Powder coated
- Different types of position indicators

Contact Rotork for further details.

WGS range



Subsea part-turn gearboxes

The WGS range of part-turn gearboxes are designed for heavy-duty subsea applications at any depth with carefully chosen materials to offer the highest level of reliability required in this very harsh environment. The operator is equipped with membrane or piston type pressure compensators to balance the pressure and allow them to work at any depth.

Torque range 2,200 to 500,000 Nm (1,623 to 368,781 lbf.ft).

- Worm shaft supported on taper roller bearings
- High strength alloy steel worm screw hardened and ground
- Vertical or horizontal carbon steel ROV input (class 2 to 7)
- Stroke: 0 to 90° ($\pm 5^\circ$ adjustable)

See [PUB036-001](#) for further details.

FB range

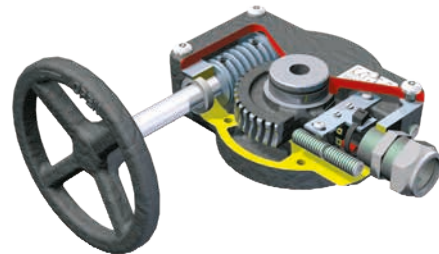

Worm gear operators

Part-turn cast iron gearbox suitable for use with fire protection (i.e. sprinkler) systems, includes limit switches to be incorporated into a supervisory electrical circuit. Designed and tested specifically to meet UL1091 specification and FM1112 approval.

Torque range up to 1,000 Nm (737 lbf.ft).
5 sizes. Ratios from 40:1 to 60:1.

- Worm gear
- Manual drive
- 3 x overload capacity
- 1,000 cycles

See [PUB093-001](#) for further details.

Gear Operators

AB-AWWA (C504 and C517) range



Part-turn worm gear operators

Worm gear operators suitable for the manual actuation of AWWA C504 butterfly valves and C517 plug valves.

Torque range up to 2,000 Nm (1,475 lbf.ft).

Ratios from 34:1 to 48:1.

- 90% grease filled for life and fully sealed
- Self-lubricating sleeve bearings
- Standard temperature range -20 to +120 °C (-4 to +250 °F)
- Above or buried service
- 300 lbf.ft overload capability
- **Options:** Stem extensions. Square nut. Padlock kit. NAMUR and Westlock position indicator mounting kit. High and low temperatures. Open right service. 450 lbf.ft overload capability (unavailable for AB550AW).

See [PUB033-010](#) for further details.

IW-AWWA (C504 and C517) range



Part-turn worm gear operators

Worm gear operators suitable for the manual actuation of AWWA C504 butterfly and C517 plug valves.

Torque range up to 164,000 Nm (120,960 lbf.ft).

Ratios from 48:1 to 2,374:1.

- 90% grease filled for life and fully sealed
- Self-lubricated drive sleeve
- Standard temperature range -40 to +120 °C (-40 to +250 °F)
- Maximum stem acceptance diameter - 12" bored with ANSI B17.1 square key
- Above or buried service
- IP68
- **Options:** Stem extensions. Padlock kit. NAMUR & Westlock position indicator mounting kit. High and low temperatures. 2" square nut. 450 lbf.ft service. Mitre box - IB2 for FA10 mounting or IB4 for FA14 mounting.

See [PUB028-003](#) for further details.

MOW range

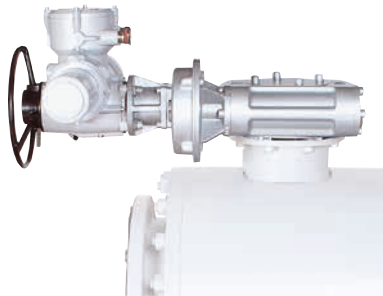

Worm gearboxes

Heavy-duty part-turn modulating gearboxes suited for control valves.

Torque range up to 46,775 Nm (34,499 lbf.ft).

9 sizes. Ratios from 40:1 to 3,000:1.

- Up to 1,200 starts per hour
- Ground and polished worm shaft
- Aluminium bronze worm wheel
- Comprehensive gear ratios combined with a selection of spur input reducers
- Angular contact bearings
- Removable output drive sleeves
- **Options:** All types of environment.

See [PUB085-006](#) for further details.

Lever Arm range



Lever arms for damper operation

Used on dampers to transfer the 90° operation from the worm gearbox to the damper spindle.

- **Option for IW Mk2 range:** This is an optional feature on all our IW Mk2 and MTW ranges of worm gearboxes.

Contact Rotork for further details.

Gear Operators

IB range



Motorised multi-turn gearboxes

Complete range of heavy-duty cast iron multi-turn bevel gearboxes suitable for the most demanding motorised applications for cast and fabricated sluice gates, gate valves and globe and pinch valves.

Torque range up to 8,135 Nm (6,000 lbf.ft).
Thrust range up to 1,320 kN (296,750 lbf).
13 sizes. Ratios from 1:1 to 120:1.

- **Common options for IB:** Spring-loaded temperature compensators. Various position indicators. AWWA. High and low temperature. All types of environment. IP68. Cast steel.

See [PUB030-001](#) for further details.

HOB/MPR range



Bevel gear operators

Hand operated bevel gears suited for sluice gates, gate, and globe valves.

Torque range up to 10,846 Nm (8,000 lbf.ft).
Thrust range up to 1,557 kN (350,028 lbf).
12 sizes. Ratios from 2:1 to 81:1.

- Cast iron body
- Maintenance free
- IP67
- **Options:** All types of environment. Position indicators. IP68.

See [PUB032-003](#) for further details.

IS range



Motorised multi-turn gearboxes

Complete range of heavy-duty cast iron multi-turn spur gearboxes suitable for the most demanding motorised applications where the gearbox input shaft needs to be parallel with the valve stem for globe and gate valves and sluice gates.

Torque range up to 46,098 Nm (34,000 lbf.ft).
Thrust range up to 2,900 kN (652,000 lbf).
19 sizes. Ratios from 1:1 to 360:1.

- **Common options for IS:** Spring-loaded temperature compensators. Various position indicators. AWWA. High and low temperature. All types of environment. IP68. Cast steel.

See [PUB031-001](#) for further details.

HOS/MPR range



Spur gear operators

Multi-turn devices intended for the manual operation of gate, globe, sluice and penstock valves. For use above and underground with upward or downward input orientation.

Torque range up to 15,917 Nm (11,740 lbf.ft).
Thrust range up to 1,557 kN (350,000 lbf).
13 sizes. Ratios from 2.04:1 to 151.9:1.

- Totally enclosed gearing
- Cast iron gearcase
- IP67

See [PUB122-001](#) for further details.

Mastergear Large Bevel Gear range



Large bevel gear operators

Complete range of ductile iron multi-turn bevel gearboxes suitable for the most demanding manual and motorised applications. Suitable for cast and fabricated sluice gates, gate valves, globe and pinch valves.

Torque range from 16,000 to 70,000 Nm (11,801 to 51,590 lbf.ft)
Thrust range from 1,100 to 6,500 kN (247,290 to 1,461,200 lbf)
Ratios from 6:1 to 480:1.

- Thrust / non-thrust taking versions
- IP67
- **Options:** Spring-loaded temperature compensators. Various position indicators. High and low temperature. All types of environment. IP68. Cast steel.

See [PUB164-001](#) for further details.

Mastergear SS Bevel range



Stainless steel bevel gear operators

Heavy-duty stainless steel 316 housing multi-turn gearboxes suitable for the most demanding manual and motorised applications. Suitable for cast and fabricated sluice gates, gate valves, globe and pinch valves.

Torque range up to 2,300 Nm (1,696 lbf.ft).
Thrust range up to 330 kN (74,200 lbf).
3 Sizes. Ratios from 4.5:1 to 20.25:1.

- Stainless steel 316 input shaft
- Thrust / non-thrust taking versions
- IP67 / IP68
- **Options:** Spring-loaded temperature compensators. Various position indicators. High and low temperature. All types of environment.

Contact Rotork for further details.

MTW range



Worm gearboxes

The multi-turn worm gearboxes are used for applications such as sluice gates and dampers.

Torque range up to 162,000 Nm (119,485 lbf.ft).
11 sizes. Ratios from 40:1 to 5,760:1.

- Ground and polished worm shaft
- Aluminium bronze worm wheel
- Comprehensive gear ratios combined with a selection of spur input reducers
- Angular contact bearings supporting worm shaft
- Removable output drive sleeves
- **Options:** Travelling nut for applications requiring mechanical stops. Lever arms. AWWA. All types of environment.

See [PUB087-005](#) for further details.

DSIR range

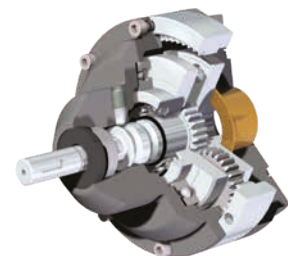

Dual speed gear operators

The Dual Speed Input Reducer is used to reduce the number of input turns required, and therefore the operating time, on manual gearbox applications. It can be used with any manual gearbox which can be fitted with an F14 or FA14 input flange.

Output torque 720 Nm (531 lbf.ft).
Ratio can be switched between 1:1 and 4.25:1.

See [PUB040-001](#) for further details.

Gear Operators and Valve Accessories

DSB range

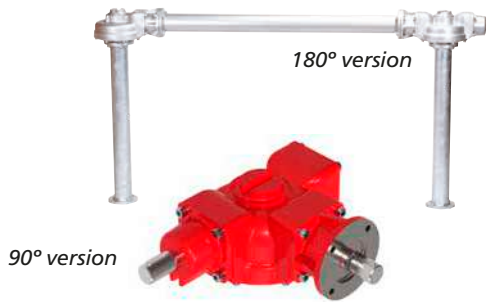

Dual shaft bevel gear operators

Complete range of multi-turn bevel gearboxes with two shafts for use with dual stem sluice gates and penstocks.

Torque range up to 8,135 Nm (6,000 lbf.ft).
Thrust range up to 1,320 kN (296,750 lbf).
13 sizes. Ratios from 1:1 to 120:1.

- Ductile iron baseplates
- Comprehensive gear ratios combined with a selection of spur input reducers
- Pinions mounted on ball bearings
- IP67
- **Options:** All types of environment. Various position indications. IP68. Input shafts available at 90° and 180° to each other.

Contact Rotork for further details.

SPI range



Smart Position Indicator (SPI)

Limit switches enclosed in an IECEx/ATEX certified protective enclosure, providing an accurate and reliable Open/Close signal to the control room for multi-turn manual valves.

4 sizes. Ratios from 34.8:1 to 1,196:1.

- Manual duty
- ISO 5210 F10 output
- Aluminium housings
- IP67
- Mount to existing F10 input flange, direct mount to rising stem valve
- **Options:** Pin / key handwheel.

See [PUB132-001](#) for further details.

Mounting kits ball, butterfly and plug valve kits



Bespoke ball, butterfly and plug valve kits

A complete range of precision CNC-machined stainless steel or carbon steel mounting kits. With open or closed construction, mounting kits are engineered from certified material, individually bagged and labelled ready for assembly.

Part-turn valve adaption for rack and pinion or pneumatic actuators can be provided in the form of spool or pedestal type mounting kits. These are fully enclosed carbon steel adaptors with options DD, square or keyed drives.

- To suit valves from 1/4" to 48"
- F03 - F35 flanges - ISO 5211/DIN 3337
- **Options:** O-ring seals, stress calculations, material certification, alternative materials, custom design, logo or brand names.

Contact Rotork for further details.

Handwheels

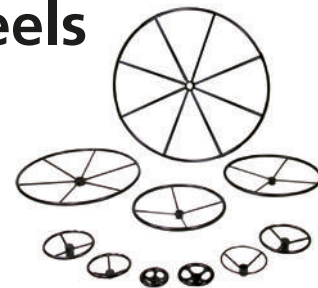

Stainless steel and powder coated handles

- 125 to 2,000 mm diameter
- Stainless steel or powder coated
- Keyed, pinned or square drive
- Fabricated or pressed design
- Oval or round designs for small valves
- **Options:** Locking flange, handle, specials, galvanised, rotating handle, flat or dished, open and closed indication marking

Contact Rotork for further details.

Valve Accessories

Remote mounting and extension spindles

Valve and actuator remote mounting and extension spindles.

Remote actuator mounting can be achieved using valve extension spindles or pedestal adaptors. Lengths can be from 500 mm to 8 m, in stainless steel or carbon steel.

Extension spindle

- Underground applications
- Customer specified extension
- Welded construction for weight saving
- Position indication option
- Suitable for manual or actuated drives
- **Options:** Oil filled, environmental sealing, galvanised, plain or dynamic bearings, swivel joints.

Remote position indicator

Mechanical remote ECL position indicators for buried service and shaft extension applications. The ECL is available in two versions, one with an F10 base plate to fit any extension with F10, and an ECL BB which has an F14 base plate to fit any extension with F14.

W100 1:1 bevel gearbox

1:1 bevel gearbox designed primarily to be used on AB and manual duty IW Mk2 part-turn gearboxes to change the input shaft direction by 90° for underground applications.

Contact Rotork for further details.

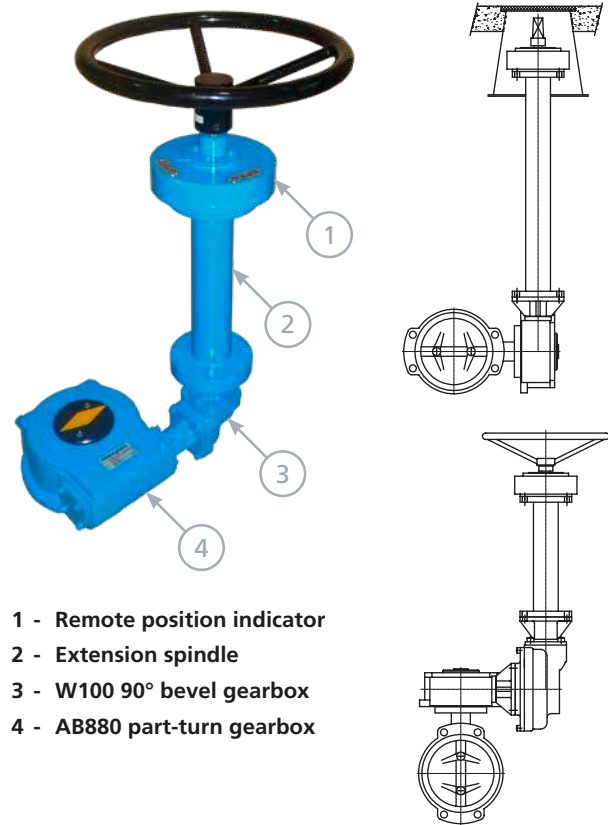

- 1 - Remote position indicator
- 2 - Extension spindle
- 3 - W100 90° bevel gearbox
- 4 - AB880 part-turn gearbox

Roto Hammer Chainwheels

range



Chainwheels and valve extensions

Roto Hammer offers the very best solutions for hard-to-reach and difficult to operate valves, with the purpose of protecting people and equipment with safe, dependable valve operation.

Roto Hammer manufacture clamp-on sprockets chainwheels to fit handwheels size from 4" to 40". They are made with different materials (ductile, aluminium and stainless steel) and protections to cater for very harsh environments.

Roto Hammer also make a variety of innovative custom solutions.

See [PUB027-056](#) for further details.

Chainwheels

range



Direct mount chainwheels

Chainwheels mount directly onto the gearbox input shaft by a pin or coupling. Suitable for use with every Rotork gearbox.

- Cast iron chainwheels 135 to 330 mm (5.32 to 13") diameter
- Chain guides and bearings are standard
- Chain and chainwheel sprockets are to DIN 766
- Galvanized or stainless steel chain available
- Epoxy coating for durability available
- **Options:** AISI316 chainwheel and chain, sheradisation protection, adaption design to suit application.

See [PUB063-038](#) for further details.

Fluid Power Actuators and Control Systems

Rotork has fluid power actuator manufacturing facilities in Italy, Sweden, China, the UK and the USA, providing the capacity to produce a high volume of products, ensuring that you deliver your projects on time.

Rotork offer a wide range of fluid power actuators spanning the following categories:

- Pneumatic rotary and linear valve actuators
- Hydraulic rotary and linear valve actuators
- Electro-hydraulic valve actuators
- Subsea valve actuators
- Vane-type pneumatic valve actuators
- Control systems

Support Centres

Wherever our clients are, Rotork can support them. We have Support Centres strategically located around the world, with superior technical assistance, comprehensive resources, dedicated systems and hundreds of directly employed engineers all able to offer OEM level support.

Design and Testing

Rotork has dedicated research and development facilities around the world combined with test facilities that include bespoke specialist testing systems, ensuring reliable operation and lifetime functionality of our products.

Our test systems incorporate the following features:

- Static continuous and dynamic analysis on a full range of torques throughout the complete stroke of the actuator
- Cyclic and repetitive tests, with variable parameters such as load, cycle times and temperature
- Automatic or manual setting and recording of pressure, position and temperature parameters
- Hydraulic filtration and flushing capabilities
- Torque testing up to 600,000 Nm (442,537 lbf.ft)
- Thrust testing up to 10,000 kgf (22,046 lbf)
- Pneumatic pressures up to 120 bar (1,740 psi)
- Hydraulic pressures up to 360 bar (5,220 psi)

Most comprehensive range of pneumatic, hydraulic and electro-hydraulic actuators available.

Superior performance actuators for on/off duty, ESD, HIPPS, protective service and special valve applications.



GT range



Rack and pinion actuators

- Double-acting and spring-return pneumatic actuators
- Fail close/fail open
- Extruded aluminum body with cast aluminum end caps
- Corrosion resistant cylinders and nickel-plated pinion
- Mechanical interfaces to ISO 5211, EN 15714-3-4, NAMUR VDI / VDE 3845
- Torque output up to 15,300 Nm (11,285 lbf.ft)
- Certified to ATEX 2014/34/EU
- Certified suitable for use at SIL3 as a single device (IEC 61508)

See [PUB110-001](#) (metric) and [PUB110-002](#) (imperial) for further details.

RC200 range



Compact scotch yoke actuators

- Extremely compact scotch yoke pneumatic actuator
- Contained spring module for safety and convenience
- Double-acting and spring-return configurations
- Fail close/fail open
- For on/off and modulating
- Torque output up to 4,400 Nm (3,245 lbf.ft)
- Valve mounting dimensions per ISO 5211/DIN 3337
- Certified to ATEX 2014/34/EU
- Certified to PED 2014/68/EU
- Certified suitable for use at SIL3 as a single device in accordance with IEC 61508
- Optional emergency manual override suitable to operate the actuator in the event of fluid supply failure

See [PUB014-001](#) (metric) and [PUB014-002](#) (imperial) for further details.

GTS range



Rack and pinion actuators

- Double-acting and spring-return pneumatic actuators
- Fail close/fail open
- Body and end caps in electro-polished stainless steel 316L
- Pistons in aluminium – stainless steel as an option
- Mechanical interfaces to ISO 5211, EN 15714-3-4, NAMUR VDI / VDE 3845
- Torque output up to 1,190 Nm (878 lbf.ft)
- Actuators certified to ATEX 2014/34/EU
- Travel stops in both open and close direction

See [PUB110-005](#) for further details.



Fluid Power Actuators

CP range



Scotch yoke actuators

- Pneumatic scotch yoke actuators (symmetric yoke)
- Double-acting and spring-return configurations
- Fail close/fail open
- For on/off and modulating
- Torque output to 4,500 Nm (3,319 lbf.ft)
- Certified to IP 66M/67M
- Certified to ATEX 2014/34/EU
- Certified in accordance with PED 2014/68/EU
- Certified suitable for use at SIL3 as a single device in accordance with IEC 61508
- Optional emergency manual override suitable to operate the actuator in the event of fluid supply failure

See [PUB013-001](#) for further details.

GP/ GH ranges



Heavy-duty scotch yoke actuators

- Pneumatic and hydraulic scotch yoke actuators (symmetric or canted yoke)
- Double-acting and spring-return configurations
- Fail close/fail open
- For on/off and modulating
- Electroless nickel-plating
- Torque output to 600,000 Nm (442,537 lbf.ft)
- Certified to IP 66M/67M
- Certified to ATEX 2014/34/EU
- Certified in accordance with PED 2014/68/EU
- Certified suitable for use at SIL3 as a single device in accordance with IEC 61508
- Optional emergency manual override suitable to operate the actuator in the event of fluid supply failure

See [PUB011-001](#) for further details.

CQ range



Compact part-turn self-contained actuators

The CQ self-contained actuator is a fully concentric design based on a helical mechanism, transforming the linear motion of the piston into a part-turn rotation of the valve stem.

- Pneumatic actuator in double-acting and spring-return configurations
- Fail close/fail open
- For on/off
- Torque output up to 150,000 Nm (110,634 lbf.ft) – higher torques are available upon request
- Certified to IP 66M/67M
- Certified to ATEX 2014/34/EU
- Certified in accordance with PED 2014/68/EU
- Certified suitable for use at SIL3 as a single device in accordance with IEC 61508

See [PUB119-001](#) for further details.



RH range



Heavy-duty and extreme-duty rack and pinion actuators

Heavy-duty RH actuators

- Hydraulic actuators in double-acting and spring-return configurations
- Torque output to 3,400 Nm (2,508 lbf.ft)
- Fail close/fail open
- For on/off and modulating
- Valve mounting dimensions per ISO 5211 DIN 3337
- Certified to IP 66M/67M
- Certified to ATEX 2014/34/EU
- Certified suitable for use at SIL3 as a single device in accordance with IEC 61508
- Optional emergency manual override suitable to operate the actuator in the event of fluid supply failure

Extreme-duty RH actuators

- Hydraulic actuators in double-acting configuration
- Torque output up to 700,000 Nm (516,293 lbf.ft), up to 5,650,000 Nm (4,167,220 lbf.ft) available on request
- Designed for some of the most challenging valve actuation applications on earth
- Balanced, compact design
- Totally enclosed weatherproof housing
- Electroless nickel-plated cylinders with redundant piston seals
- Mechanical interfaces to ISO 5211
- Lifting lugs to support the actuator and valve

See [PUB019-004](#) for further details.

LP/ LH ranges



Linear actuators

- Pneumatic and hydraulic actuators in double-acting and spring-return configurations
- Electroless nickel-plated cylinders, chromium-plated piston rods
- Hammer blow and standard valve stem coupling designs available
- Thrust up to 5,500 kN (1,236,449 lbf)
- Certified to IP 66M/67M and ATEX 2014/34/EU
- Certified in accordance with PED 2014/68/EU
- Certified suitable for use at SIL3 as a single device in accordance with IEC 61508
- Optional emergency manual override suitable to operate the actuator in the event of fluid supply failure

See [PUB020-001](#) for further details.



Skilmatic SI

range

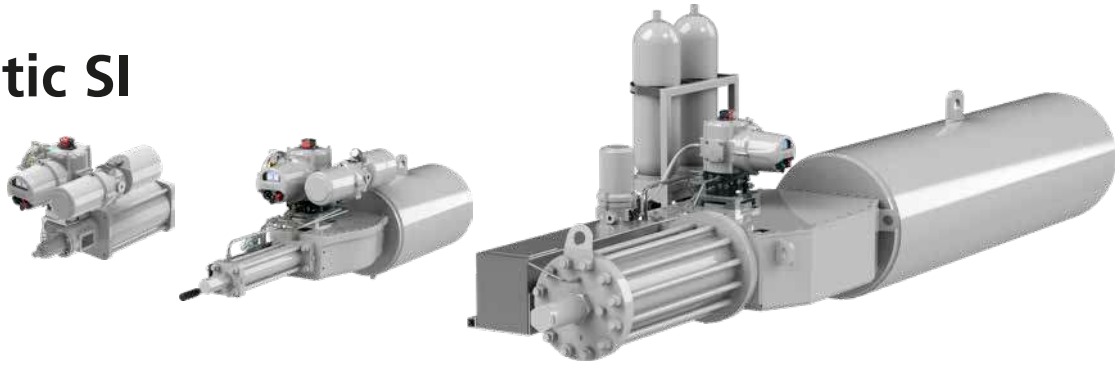

Electro-hydraulic actuators

The Skilmatic SI range of intelligent self-contained electro-hydraulic actuators designed to meet today's control and safety needs for both two position and positioning control applications. Featuring a large display for position, pressure, diagnostics and status indication and utilising Bluetooth for configuration, setting and downloading actuator data.

- 1-phase and 3-phase power supply
- Failsafe to close, open or lock in last position
- Spring-return configuration
- Linear output: up to 400 kN (90,000 lbf)
- Part-turn output: up to 200,000 Nm (147,500 lbf.ft)
- Configurable Partial Stroke Testing (PST)
- Certified as suitable for use in SIL applications
- Positioning control option 4-20 mA input and output, resolution to <0.25%
- Network options include *Pakscan*, Profibus, Modbus, HART and Foundation Fieldbus
- Data logger, recording up to 3,000 events
- Watertight and explosionproof Ex d IIB/IIC T4 – ATEX, IEC, EAC and CSA. TÜV Functional Safety SIL certified to IEC 61508-2:2010
- Operating temperature -50 to +70 °C (-58 to +158 °F)

See [PUB021-064](#) for further details.

RHS



Remote Hand Station

The Remote Hand Station enables duplicated operation, interrogation and configuration of the latest SI actuators. For use when the actuator is located in a hazardous or inaccessible location.

- Installation using standard data cable, up to 100 m (328 ft) away from the actuator
- Full replication of actuator configuration, control, monitoring and downloadable data
- Powered from the attached actuator, no need for additional power supply

See [PUB002-056](#) for further details.



GO range



Gas-over-Oil actuators

- Scotch yoke, rack & pinion or linear double-acting actuators
- Hydraulic manual override as standard
- Speed control in both directions as standard
- Torque output to 600,000 Nm (442,537 lbf.ft)
- Extremely wide range of high-pressure control logic options
- Certified to IP 66M/67M
- Certified to ATEX 2014/34/EU
- Certified in accordance with PED 2014/68/EU
- PED or ASME approved gas/oil and power gas storage tanks

See [PUB017-001](#) for further details.

HPG range

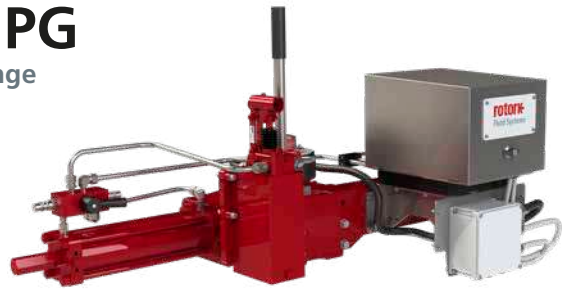

Direct high-pressure gas actuators

- Scotch yoke double-acting actuators
- Hydraulic manual override standard
- Speed control in both directions standard
- Torque output to 600,000 Nm (442,537 lbf.ft)
- Extremely wide range of high-pressure control logic options
- Certified to IP 66M/67M
- Certified to ATEX 2014/34/EU
- Certified in accordance with PED 2014/68/EU
- PED or ASME approved gas/oil and power gas storage tanks

See [PUB016-001](#) for further details.

ELB



Pipeline pressure monitoring system

Rotork's ELB, the electronic linebreak detection system is designed to continuously monitor pipeline pressure and provide automatic valve actuator movement to an emergency position.

- Comprehensive data logging with real-time clock
- Configuration and data retrieval via Rotork Bluetooth® Setting Tool *Pro* or PC (using Rotork's Insight 2 software)
- Configurable fail position to close, open, stay put
- Optional manual reset requirement
- Local controls for open, close, local/remote/stop
- Remote control via either hard-wired connections or Modbus® serial communication protocol
- Certified to IECEx Hazardous Area Approvals
- Certified IP66/IP68 and NEMA 4, 4X & 6

See [PUB127-001](#) for further details.



K-TORK range



Vane actuators

- Pneumatic actuators in double-acting and spring-return configurations
- Compact no-sideload, constant-torque design with output to 18,300 Nm (13,497 lbf.ft)
- Certified to IP66M/IP67M and meets NEMA 4/4X
- Certified to ATEX 2014/34/EU
- Complies with ANSI / AWWA C540-02 and C541-08
- Conforms to VDI / VDE 3485 control accessory mounting standards
- Modulating accuracy of 0.25% or better
- Capable of millions of operations at fast cycle times

See [PUB097-001](#) for further details.

TYPE K range



Damper drives

- Direct 'drop-in place' design matches existing damper drive take-out dimensions
- Rotary and linear versions available
- Torque output up to 16,875 Nm (12,446 lbf.ft)
- High-speed operation as quick as 3-5 seconds full scale
- High temperature options up to +149 °C (+300 °F)
- Highly accurate and responsive
- Designed for safety and serviceability in harsh environments
- Infinite duty cycle
- Control options: Profibus®, HART® and Foundation Fieldbus® control. Pneumatic, analogue and digital positioners

See [PUB000-062](#) for further details.

Subsea range



Subsea actuators

The subsea product range encompasses actuator and gearbox designs for retrievable and non-retrievable applications. We are familiar with supplying subsea products to meet the harsh conditions and stringent demands of subsea applications.

- Hydraulic part-turn and linear subsea actuators in double-acting and spring-return configurations
- Subsea and splashzone trims
- Retrievable and non-retrievable designs
- Multitude of design options available
- Installed base dating back to 1992 at depths up to 2,500 m

See [PUB022-001](#) for further details.



manPOWER

range



Self-contained failsafe actuator

- The self-contained hydraulics provide high-integrity failsafe valve operation without the need for any external power supply
- Suitable for workshop or field mounting on a wide range of rotary and linear operated valves and dampers
- Manually energised, spring-return failsafe operation
- Cost-effective solution for infrequently operated valves and dampers
- Watertight or explosionproof construction
- Highly configurable with a multitude of options

See [PUB062-002](#) for further details.

HPU

range

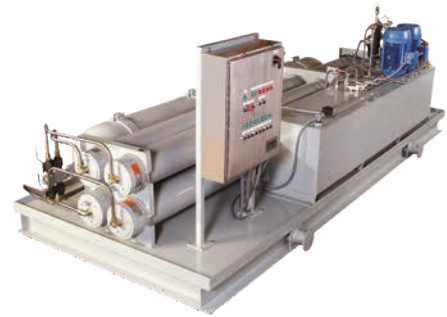

Hydraulic power units

- Hydraulic fluid capacity from 19 to 7,570 litres (5 to 2,000 U.S. gal)
- Operating pressures up to 345 bar (5,000 psi)
- Flow rates up to 3,785 lpm (1,000 U.S. gpm)
- Electrical classifications: NEMA 4, 4X & 7 or comparable CSA or ATEX ratings
- Custom engineered solutions to meet the specific demands of each application

See [PUB062-001](#) for further details.



Control systems

Control component packages are a part of any actuator / valve installation. Rotork has extensive experience in the design and assembly of all types of fluid power control systems to satisfy any customer requirement for on / off, modulating or ESD (emergency shutdown) service. Packages can be mounted on a panel or in a cabinet and mounted either on the actuator or at a remote location.

Rotork offers components from all leading industry suppliers as well as those of our own design including limit switch housings, quick exhaust valves, pneumatic and hydraulic manifolds, filter regulators, shuttle valves, linebreak safety systems, partial stroke testing and a torque limiting device.



Instrumentation and Control

Rotork have a number of instrumentation equipment production facilities throughout the world, complemented by a large network of distribution and support centres.

Worldwide Industry and Application Experience

Rotork offer a complete range of precision control and valve accessory products through our prestigious brands, including Fairchild, Soldo®, Midland-ACST™, Bifold®, M&M, Alcon and YTC.

Instrument Valves

- Valve actuation accessories
- Solenoid valves
- Piston valves
- Instrument valves
- Medium pressure valves
- Subsea valves and connectors

Regulators

- Volume boosters
- Filter regulators
- Pressure regulators – including high pressure products for hydrogen applications

Controllers

- Valve positioners
- Rail systems
- I/P and E/P converters

Measurement

- Valve position sensors
- Transmitters and switches

Instrument Pumps

- Pumps
- Intensifiers and accumulators

Rotork is proud to offer a diverse range of products which serve many different duties in a wide variety of applications. We also offer a factory customisation service to create one-off units to meet specific needs.

Specialist products for control and measurement of flow and pressure.

Trusted wherever there is a need for high precision and reliability, including oil & gas, pharmaceutical, biomedical, and manufacturing industries.



Instrument Valves



Valve actuator accessories

Rotork offers the widest range of precision products for actuation control systems, with the highest flow rates and efficiency factors. System components are available for piped, nipple and modular mounting arrangements and in a range of materials.

- Filters, regulators, flow control, volume boosters, HIPEX
- Relief, pressure sensing and stick pilot valves
- Check and quick exhaust valves
- Pilot and mechanical valves
- Modular manifolds
- Fire safety valves

Contact Rotork and see: [PUB103-005](#) (Fairchild); [PUB126-001](#) (Valve Positioners); [PUB117-001](#) / [PUB117-005](#) / [PUB117-006](#) / [PUB117-009](#) (Midland-ACS) for further details.



Solenoid valves

Rotork offers a comprehensive range of pneumatic and hydraulic solenoid valves for hazardous and safe area installation. Available in stainless steel, brass and aluminium with threaded and NAMUR connections. Rotork solenoids offer the highest levels of safety factors and global certification.

- Solenoid valves available from 1/4" to 8" sizes
- Manual reset and manual override options
- Normally open, normally closed and diverting
- Up to 1,380 bar (20,000 psi) working pressure
- Low temperature and low power versions

Contact Rotork and see [PUB124-005](#) and [PUB117-011](#) for further details.



Piston valves

Rotork piston actuated valves are manufactured with high performing components as a standard. PTFE and FKM seals, together with internals in AISI 316, offer outstanding compatibility and cover a wide variety of industrial applications. A wide choice of connections are available, including flanged, clamped and weld versions.

- Available from 1/2" to 2" sizes
- Normally Open, Normally Closed and bi-directional options
- Position indicator
- Built-in exhaust filter
- On/Off or modulating control configuration

See [PUB125-001](#) for further details.

Instrument Valves

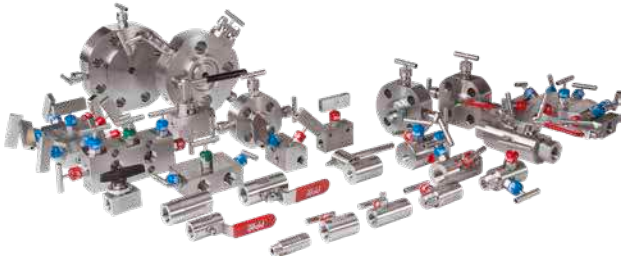

Instrument valves

Rotork offers state of the art, precision engineered instrumentation valve solutions products, such as needle valves, ball valves and Double Block and Bleed (DBB) valves in single or combined valve arrangements.

- One piece body construction
- ¼" to 1" sizes
- Pressure range up to 689 bar (10,000 psi)

Contact Rotork for further details.

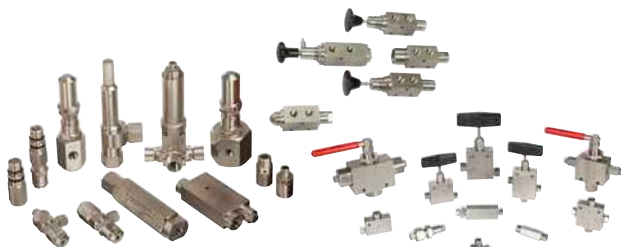
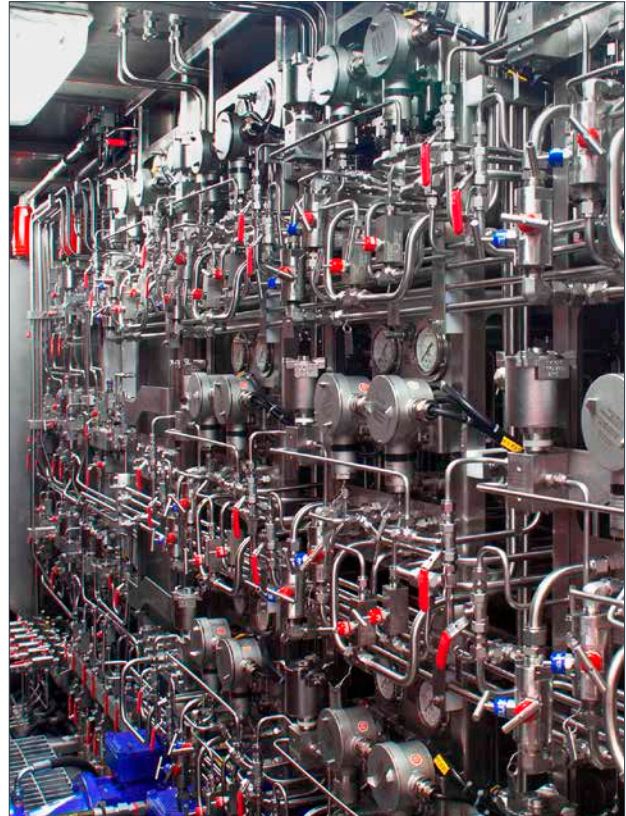

Medium pressure valves

The portfolio of medium pressure products allows for the safe and reliable implementation of 1,379 bar (20,000 psi) pressure systems incorporating needle valves, ball valves, single block and bleed manifolds, Double Block and Bleed (DBB) manifolds, check valves, fittings and adaptors. The medium pressure valves are available in ¼", ⅜", ⅝", ¾" and 1" tubing sizes comprising of a coned and threaded connection. This connection method allows for increased flow rates due to the larger bore sizes.

- Innovative locking device for ball valves
- Maintenance free stem sealing
- Non-wetted threads
- Lower torque to operate

See [PUB171-001](#) for further details.



Subsea valves and connectors

Experience gained since 1987 of successfully applying valves directly immersed in seawater has been applied to develop the technically superior, market leading performance, FPS10 range of shearseal type directional valves. Fully seawater compatible, the standard products operate on fluids with contamination levels greater than NAS 1638 Class 12. These are true failsafe valves offering the benefits of reduced manifold weight, size and cost.

- Subsea valves
- Subsea connectors and stab plates
- Subsea gate, needle, ball and manual valves

Contact Rotork for further details.

Instrument Valves and Controllers



Valve positioners

Rotork offers a comprehensive range of valve positioners and valve controllers for all actuator types. Applying piezo, torque motor and digital electronics technologies, Rotork provides solutions from the simplest to the most sophisticated valve position control requirements.

- Pneumatic and electro-pneumatic positioners
- Smart positioners with network control and diagnostics
- Electronic digital controllers and SIS systems
- Zero leakage designs
- Partial stroke testing
- HART protocol and diagnostic capabilities
- Profibus and Foundation Fieldbus options

Contact Rotork and see [PUB126-001](#) for further details.



Rail systems

Rotork has been providing critical components and safety systems to the rail industry for over 20 years. They range from a simple manual system to an advanced full automated control system.

- Specialist freight rail wagon door systems
- Fully automated control systems for door
- High reliability solutions for brake and traction control
- Double-acting, fully-adjustable cushioned metric cylinders to VDMA 24562 and BS ISO 6431 standards
- Train stop braking controls and points motors
- Unique product portfolio for tunnel ventilation solutions

See [PUB108-013](#) for further details.



Logic valves

Compact design 1/2" and 2" poppet valves available in 1, 2 or 3 port exhaust units. Certified as SIL 3 capable and positively sealed for low pressure applications up to 145 psi / 10 bar operating pressure.

- Arctic service options to -60 °C
- Valve body 316L stainless steel, aluminium options available
- Ports: 1/2" up to 2" NPT & BSP
- NACE-MR-01-75 Option
- High flow - up to 103.0 Cv
- Extensive Valve Operator Options

See [SPR-PPV](#) for further details.



I/P and E/P controllers

Rotork fast response, high flow, compact I/P, E/P, D/P and P/I electro-pneumatic converters have extensive combinations of inputs and outputs, carry standard UKCA, UKEX, CCC, FM, CSA, ATEX or IECEx agency approvals, and maintain accuracies of up to 0.15%. Fast response, high flow and high accuracy models feature proportional pressure regulation.

- Hazardous and safe area models
- High accuracy
- High performance

See [PUB103-005](#) and [PUB126-001](#) for further details.

Indication and Measurement



Limit switches

Our extensive range of limit switches offer visual indication with digital, and analogue feedback, via HART protocol. Our Soldo limit switch range is based on our unique twin shaft design which enables easier and safer disassembly for installation and maintenance. All designs are corrosion-resistant and suitable for a wide range of environments in hazardous and safe areas. Material options include polymer, aluminium and stainless steel.

Refer to [PUB109-003](#) for further details.



Transmitters and switches

Rotork manufacture pressure and position sensing components and devices providing digital or 4-20 mA and HART protocol feedback. Suitable for high pressure and high vibration applications, with accurate repeatability giving reliable performance.

- Pressure transmitters
- Position transmitters
- Pressure switches

Contact Rotork and refer to [PUB126-001](#) for further details.





Intensifiers and accumulators

Pressure intensifiers for topside and subsea applications. The innovative designs can boost pressure by a factor of up to 7 without external power, operating with any water-based or mineral / synthetic oil-based fluid. Inlet pressures up to 420 bar (6,000 psi) and outlet pressure up to 1,380 bar (20,000 psi). Once the required high pressure is achieved, the pressure intensifier maintains it without consumption of fluid. Any pressure leak is automatically corrected.

- Ratios from 2:1 to 10:1
- Topside and subsea versions
- Suitable for mineral or synthetic oils – or with any water / glycol mix
- Qualification testing at pressures of 207 to 1,000 bar (3,000 to 14,500 psi) to approximately 500,000 cycles

Contact Rotork for further details.



Pumps

Rotork offers a range of high quality hydraulic pumps for applications in the upstream and downstream oil and gas industries. These include an extensive range of axial piston oil pumps which provide cost-effective solutions to any flow and pressure requirements. From the 0.23 l/m SM pump to the 193 l/m XH with pressures up to 690 bar (10,000 psi) for most ranges and even up to 1,040 bar (15,000 psi) for the X pump.

- Water/glycol, water and oil service
- Chemical injection applications
- High pressure up to 1,040 bar (15,000 psi)
- Lubricated and rotating swash plate designs

Contact Rotork for further details.

Modular Systems



Manifolds - Modular Solution Range

Rotork's modular manifold system allows fast configuration and delivery of accurate and reliable instrumentation configurations to suit your application.

- 360° fully rotational solenoid housing
- Worldwide solenoid approvals
- Booster manifolds available
- Patented stacker system
- Compact low cost version
- High system flow
- 316L stainless steel
- 3D modelling system design

Our modular systems deliver reduction in:

- Cost
- Components (below cost of separate valves and fittings)
- Panel (smaller panel/back plate required and fixings)
- Labour (reduce labour cost of fabricating system)
- Weight
- Eliminate fittings, tubing
- Smaller mounting plate
- Minimal mounting requirements

Specifications:

- Ambient temperature range -60 to +90 °C (-13 to +194 °F)
- Pressure range 0 - 10 bar (0 - 145 psig)
- Flow rate from 0.73 Cv up to 11.2 Cv (XS04-04 up to XS16-16)
- Ports: ¼" up to 1" NPT & BSP (XS04-04 up to XS16-16)
- Solenoid classification: Ex d IIC, Ex emb IIC, Ex ia IIC
- IP66, IP67 and NEMA 4X

Contact Rotork for further details.

Site Services

Rotork Site Services (RSS) provides the essential on-site actuator service, repair, maintenance and upgrades part of our service offering, plus the commissioning of new actuators and applications. It includes off-site work completed at a Rotork Support Centre including recertification, automation, testing and product selection.

Our decades of experience in the industrial actuation and flow control markets means that customers can rely on us to understand their problems and to deliver reliable, economic solutions. Rotork's talented and experienced engineers have an in-depth understanding of the problems that are faced in the field and they know how to fix them.

On sites where providing evidence of valid asset certification is a legal requirement, Rotork engineers can carry out the necessary OEM level inspections and provide the statutory paperwork to comply with regulations.

- Field Support
- Planned Shutdown Support
- Actuator Workshop Overhaul
- Valve Automation Services
 - On-site
 - Off-site
- Global Support

Planned Shutdown Support

Planned and strategic shutdown support can reduce site downtime; we can carry out different projects simultaneously to ensure that customers make the most of their plant shutdown times. A wide range of services from our portfolio make up Planned Shutdown Support. We will work with our clients to develop an optimum set of services, ensuring plant down time is kept to a minimum. We can also provide project management and supervision of your plant overhaul, as well as managing the key return-to-service dates.

Actuator Workshop Overhaul

Rotork offer complete workshop overhauls for actuators. There are many benefits to an overhaul within a workshop rather than a complete replacement, such as reduced downtime, a Rotork warranty is provided and OEM parts are used to ensure performance and reliability. During an overhaul, our workshop rigs allow for detailed fault analysis and actuators are torque/thrust tested.

- Rotork and non-Rotork products
- Workshop facilities including torque testing and re-coating
- Large OEM stock in all workshops
- Loan actuator facilities

Field Support

Rotork service engineers are trained to work on customer sites and in the field to provide the essential maintenance, repairs and commissioning needed for actuators to work effectively and efficiently.

- Site repairs and commissioning
- Upgrades
- Fault finding and maintenance
- Maintenance planning and scheduling if desired

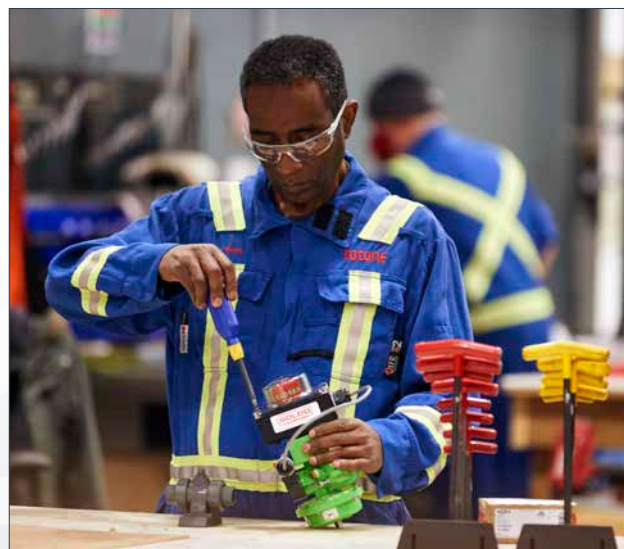

Site Services

Valve Automation Services

Rotork's manual valve automation and actuator replacement involves work to automate existing manual valves and to replace obsolete actuators. On completion of work, every overhauled actuator is torque rig tested and a test certificate is provided confirming that its performance is identical to the day that it was built. We service and repair Rotork and non-Rotork actuators.

Valve Automation Services – On-Site

Rotork engineers are experts in their fields and have years of experience of valve automation and are able to design, manufacture, supply and provide installation services to automate existing manual valves, penstocks or dampers.

- Power supplies, uninterruptable power supplies, distribution boards, motor control centres
- System integration
- Control system design, PLC, bus systems, logic, flow control systems, PID control, fail-safe critical plant
- Full Mechanical, Electrical, Instrumentation, Control and Automation (MEICA) by our qualified installation team
- Correct product selection for the right application
- Design and manufacture of adaption components
- Electrical interface design and installation
- Fully commissioned to the plant control room
- Extended warranty on all products installed by Rotork



Valve Automation Services – Off-Site

Service engineers provide automation of new or refurbished valves in our dedicated Support Centres around the world.

- Correct product selection to suit process demands
- Design and manufacture of all engineered components
- Correct assembly of valve and actuator/gearbox combinations
- Selection and procurement of the preferred or specified valve for your application
- Free issue valves accepted for automation in our Support Centres
- Packed and shipped to the desired destination

Global Support

With over 60 years experience of service support for the industrial actuation and flow control markets, our expertise delivers improved safety, greater productivity and reduced maintenance for plants and equipment. With established worldwide Support Centres we are able to offer same-day or next-day service to the majority of our customers. We are a global company with local support, working across the globe and servicing a diverse range of markets and critical applications. We use internationally recognised quality management standards to ensure consistently high levels of service worldwide. Our experienced engineers form a global team of service professionals who work together to ensure your assets are protected and costly downtime is minimised.



Lifetime Management

Lifetime Management is the suite of services within Rotork Site Services which help you manage the life cycle of your assets. The services available offer a complete solution to managing the risks associated with the life cycle of your equipment and their obsolescence (which compromise reliable performance and valuable uptime).

The aim of Lifetime Management is to provide you with constant support and minimum- to- no disruption to your production flow. It is a customisable service offering, designed to seamlessly maintain and improve your assets. We manage the inherent risks associated with advances in technology, component obsolescence and ageing equipment for you. We are committed to helping customers maximise the continuous, fault-free operation and working life of their actuators. Supporting the continuous and reliable operation of your plant allows for improved performance and increases in valuable uptime.

Lifetime Management has several service offerings that provide a solution to managing the risks associated with ageing equipment and obsolescence, keeping your production active and reducing costly downtime. Upgrade services and overhauls/refurbishments are part of our commitment to support our customers through periods of change. We can carry out upgrade projects simultaneously, to ensure that customers have the shortest shutdown possible.

Our life cycle services identify the stages your equipment goes through during its life and implement controlled strategies for managing the risk of ageing equipment. This future-proofing means we ensure a seamless transition when upgrading to the latest equipment; we help maintain and keep your operation up to date to allow you to focus on your operational goals, with constant support and limited disruption to your production flow. Within the Lifetime Management programme we can offer a customised spares programme, tailoring it to exactly what you need and when you need it. Training and consultancy services are offered.

Reliability Services

Reliability Services is part of Rotork's Lifetime Management suite of services. It is a customisable approach to maintenance, with options that provide progressively increased levels of coverage and support. Our tailor-made programmes increase reliability and availability and allow customers to have flexibility about what services are most appropriate for them.

There are three primary levels within Reliability Services; each level increases asset reliability and includes the services from the previous tier. These levels are: 'Basic - Health Check', 'Standard - Planned Maintenance' and 'Premium - Enhanced Maintenance'.



Lifetime Management

Lifetime Management covers:

- Reliability Services
 - Basic - Health Check
 - Standard - Planned Maintenance
 - Premium - Enhanced Maintenance
- Upgrade Services (Retrofit)
- Planned Shutdown Support
- Life Cycle Services
- Overhauls/Refurbishment
- Customised Spares Programme
- Intelligent Asset Management Reporting

Lifetime Management benefits:

- Increased Uptime/Reduced Downtime
- Maximised Productivity
- Reduced Operational Risk
- Increased Reliability
- Improved Maintenance Efficiency
- Reduced Cost of Ownership
- Extension of Asset Life Cycle

Intelligent Asset Management

Intelligent Asset Management is a cloud-based asset management system for intelligent actuators and the flow control equipment they operate. Failure of key equipment can result in poor performance, poor quality, reduced output yields and reputational damage. The solution is a planned maintenance strategy with advanced analytics, condition monitoring and anomaly detection.

Intelligent Asset Management collects information from the data logs held within intelligent actuators. This information is used to keep sites working efficiently and reliably.

As part of the Industrial Internet of Things (IIoT), Intelligent Asset Management is web based and easy to access. It provides easy and accurate reporting/monitoring of the condition of valves/flow control assets and anomaly detection, enabling proactive maintenance. It is a robust, safe and secure online platform with a simple to use intuitive interface that can run on all operating systems.

To learn how Lifetime Management and Intelligent Asset Management can help you, contact Rotork now.



rotork®



www.rotork.com

A full listing of our worldwide sales and service network is available on our website.

Rotork plc
Brassmill Lane, Bath, UK
tel +44 (0)1225 733200
email mail@rotork.com

PUB000-002-00
Issue 07/23

As part of a process of on-going product development, Rotork reserves the right to amend and change specifications without prior notice. Published data may be subject to change. For the very latest version release, visit our website at www.rotork.com

The name Rotork is a registered trademark. Rotork recognises all registered trademarks. The Bluetooth® word mark and logos are registered trademarks owned by Bluetooth SIG, Inc. and any use of such marks by Rotork is under license. Published and produced in the UK by Rotork. POLTG0823